

Dongguan Hongke Lighting Co.,LTD

Tel:86-769-85933616

Fax:86-769-85994676

Email:sales1@hklighting.com.cn

LED Product Specifications

Product Name: 3 watts 685nm Red LED;

Version No.: 01

Product Description:

- 3 Watts high power LED
- Colloid Color: Water clear
- Emission Color: Red
- Viewing Angle:140°

Dice Material: InGaAlN



Add.No.3 Gongye Street, Baihao Industrial District, Houjie Town, Dongguan City, Guangdong Province, China 523957

Dongguan Hongke Lighting Co.,LTD

Tel:86-769-28682546

Fax:86-769-28682546

Email:sales1@hklighting.com.cn

Outline Drawing

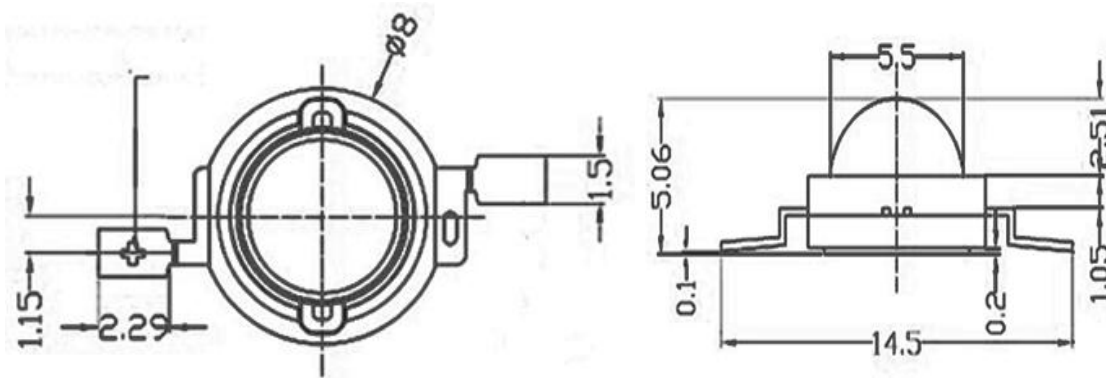

Notes:

1. All dimensions area in mm tolerance is $\pm 0.25\text{mm}$ unless otherwise noted.
2. An epoxy meniscus may extend about 1.2mm down the leads.
3. Burr around bottom of epoxy may be 0.5mm max.

Add:No.3 Gongye Street, Baihao Industrial District, Houjie Town, Dongguan City, Guangdong Province, China 523957 2

Dongguan Hongke Lighting Co.,LTD

Tel:86-769-28682546

Fax:86-769-28682546

Email:sales1@hklighting.com.cn

Absolute Maximum Ratings (Ta = 25°C)

Items	Symbol	Maximum	Units
DC Forward Current	I_F	500	mA
Peak pulse current	I_{Pulse}	600	mA
Reverse Voltage	V_R	10	V
Power consumption	P_D	3	W
Operation Temperature	T_{opr}	-20~+75	°C
Storage Temperature	T_{stg}	-30~+80	°C
Lead Soldering Temperature	T_{sol} (3mm from the base of the body)	Max 260°C for 5 sec Max.	

* Pulse width ≤ 0.1 msec duty $\leq 1/10$

Product Optical Properties (Ta = 25°C)

Item	Symbol	Conditions	Min	Average	Max	Units
Forward Voltage	V_F	$I_F = 500$ mA	2.2	----	2.4	V
Reverse current	I_R	$V_R = 10$ V	---	10	---	μ A
Color Temperature	CCT	$I_F = 500$ mA	----	----	---	K
Peak Wavelength	λ_p	$I_F = 500$ mA	685	---	690	nm
Luminous Intensity	I_v	$I_F = 500$ mA	30	---	50	lm
50% power Angle	$2\theta^{1/2}_{H-H}$	$I_F = 500$ mA	---	145	---	deg
	$2\theta^{1/2}_{V-V}$	$I_F = 500$ mA	---	---	---	deg

Add:No.3 Gongye Street, Baihao Industrial District, Houjie Town, Dongguan City, Guangdong Province, China 523957

Dongguan Hongke Lighting Co.,LTD

Tel:86-769-28682546

Fax:86-769-28682546

Email:sales1@hklighting.com.cn

Important Notes:

- 1) All ranks will be included per delivery; rank ratio will be determined by Hongke.
- 2) Tolerance of measurement of luminous intensity is $\pm 15\%$.
- 3) Tolerance of measurement of VF is ± 0.05 V.
- 4) Color Coordinates Measurement allowance is ± 0.015 .
- 5) For reliability test conditions and data, Please refer to "Reliability Test" section on page 6.
- 6) As we are making continuous efforts to improve the performance of LED, Specifications are subject to change without notice.

Add:No.3 Gongye Street, Baihao Industrial District, Houjie Town, Dongguan City, Guangdong Province, China 523957