



**LEDWIDE**

Linear and Curved Lighting Specialist

## LED PROFILE

2020-2021

PRODUCT  
CATALOGUE





# Ledwide Company Presentation



Company

Shenzhen Ledwide Lighting Co., Ltd. Established in 2010, as a leading green lighting technology manufacturer, specializes in the manufacturing of innovative, next-generation LED lighting solutions that improve lighting quality, improve efficiency, and enhance the environment through reduced energy consumption. We offer full lighting solutions with over 10 years experience in the lighting field. Now our products are mainly sold to markets such as Europe, Australia & New Zealand, UAE and USA.

Our Main products are Led aluminium profiles, Led Linear light, led strips and led drivers. Unique design, multi-functional, stable quality and fast response to customer requirement is our success to cooperate with long term customers worldwide. Our aluminum profiles are used in 6063 grade with T5 temper, and we have CE and RoHS certificates, and with strict quality control system to ensure the finish, dimension, function, which ensure 5 years+ warranty.

Today, we continuously develop and improve our products and the processes necessary to fulfill today's needs for quality, energy-efficient, eco-friendly lighting solutions.

"Customer first" is our core culture, and we're devoted to providing more and more "custom lighting solutions". Our Core Value is Quality, Innovation, Integrity. It is our great honor to work with you.

Ledwide, always be your trusted partner in LED lighting field. Welcome to visit us.



Reception



Office



Production



Production

Will Wang  
Manage Director



# Authentication



# Index April 2020

●	Company presentation .....	3
●	Production lines .....	6
●	Ledwide advantage .....	8
●	Marketing support .....	10
●	Black diffuser .....	11
●	Index of series .....	12
	● Led profiles <b>Surface</b> .....	18
	● Led profiles <b>Recessed</b> .....	38
	● Led profiles <b>Corner</b> .....	52
	● Led profiles <b>Surface &amp; Suspension</b> .....	64
	● Led profiles <b>Waterproof</b> .....	80
	● Led profiles <b>Step and Stair</b> .....	94
	● Led profiles <b>Round</b> .....	102
	● Led profiles <b>Wall</b> .....	110
	● Led profiles <b>Driver Built-in</b> .....	124
	● Led profiles <b>Trimless -Architectural</b> .....	138
	● Led profiles <b>Surface &amp; Suspension -Architectural</b> ...	148
	● Led profiles <b>Recessed - Architectural</b> .....	166
	● Led profiles <b>Plaster in Trimless</b> .....	180
	● Led profiles <b>Bend &amp; Curved</b> .....	198
●	Accessories .....	202
●	Projects .....	205

## Profiles Manufacturing



**Aluminum Billet**



**Aluminum Profile Die**



**Profile Extrusion**



**Profile Anodizing**

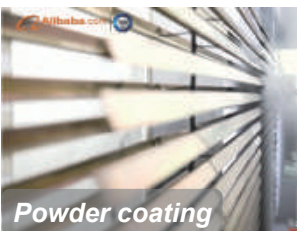

**Powder coating**

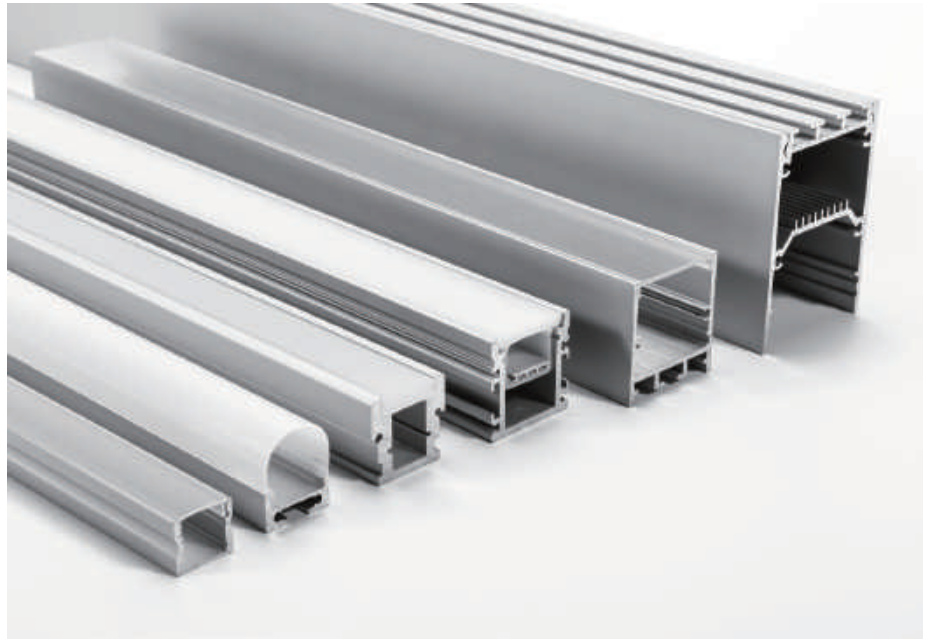

The vast majority of profiles in this catalog have been conceived, designed by Ledwide and manufactured in Foshan city (our joint venture factory). For this we have used an excellent raw material and have been manufactured under quality standards more demanding and rigorous in profile dies, extruding, anodized, polishing and powder coating etc ...

Quality aluminum profile (5 years warranty) with tolerances that are following European Directives: LVD 2014/35/EU, EN 62493:2015; EN 62471:2008. The alloy used is 6063 starting from an aluminum "billet" with a purity between 95-98% and applying a T5 treatment.

The anodized ones we have made from thickness of 1.2mm to 3.5mm for better heat dissipation, and a max. length 6000mm.

## Lens / Diffusers Manufacturing

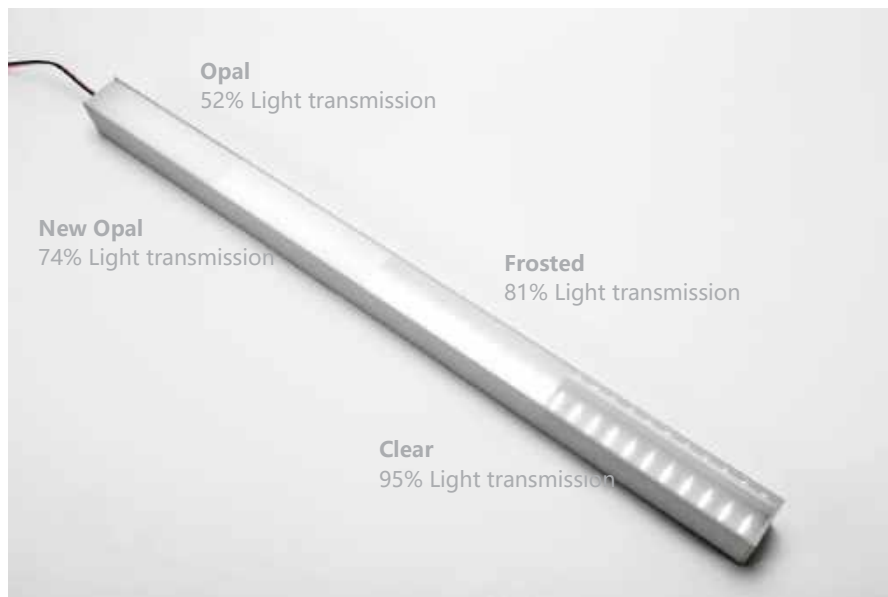
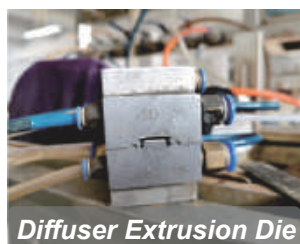

Ledwide using monomer from Germany Brand "Evonik" UV resistant PMMA/Acrylic diffusers (at least 2 years warranty) to suit most of ALU profile extrusions.

PMMA: a material with high optical performances, used in applications involving highest transparency and great diffusing properties.

Using LED CONTROL colors, great performances in LED lighting are ensured, like the invisibility of spots and an excellent transmission-diffusion ration.

PMMA, which is actually a fragile material, but Ledwide has successfully reinforced with HIGH-IMPACT resistant material, more it flexible and can be rolled package for easy delivery.

Also for this material, LEDWIDE offers finishes like Opal, Frosted, Milky, Transparent, colored, striped, microprismatic. PMMA is a UV-resistant material, so no further protections are required.

Thanks to the blend of different materials diffusion effects are obtained, that result in high transparency, completely hiding the LED-Spots.

A great innovation for LED-Lamps satisfying all customer's requests in term of esthetic and functionality, colours, flexibility and innovation.



**100% OWN DESIGNED W/ UNIQUE ADVANTAGE**



**95% EXPORTATION TO 30+ COUNTRIES**



**5 STAR FEEDBACKS FROM CUSTOMERS**



**TUV, CE ROHS, IES, TEST REPORT AVAILABLE**



**CUSTOMIZED SERVICE**



**3D**



**Customized RAL colors**



**LED assembling**



**Custom cutting**



**Retail package**



**100% OWN DESIGNED W/  
UNIQUE ADVANTAGE - P50N**

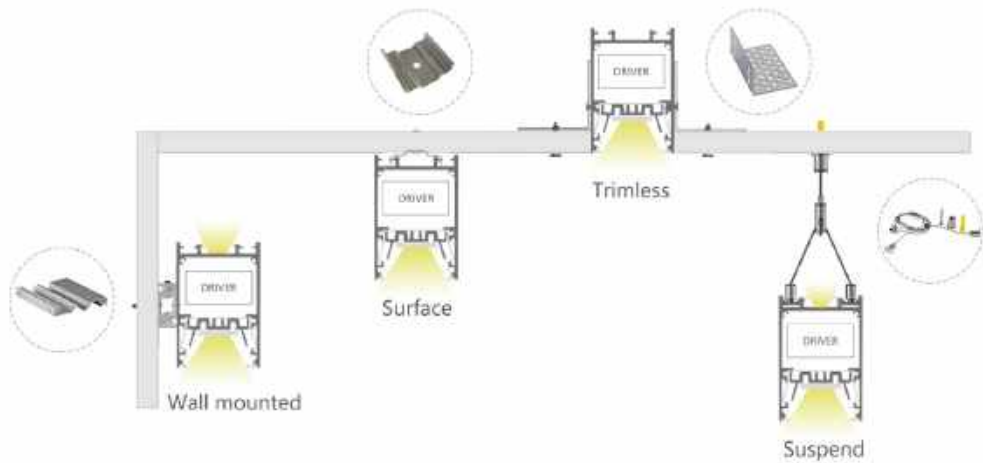
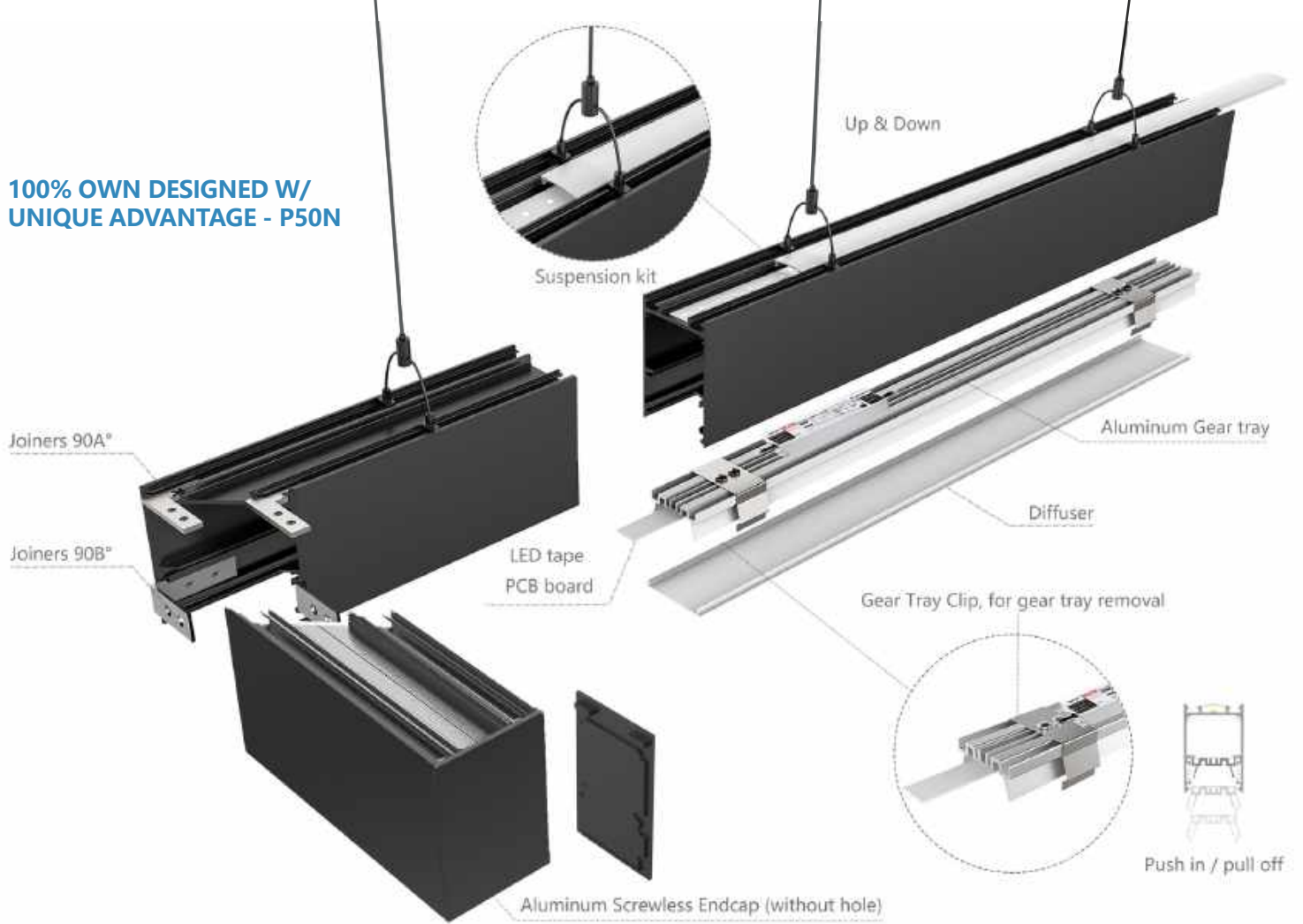

Ledwide is offering our long term customers following services helps your businesses to take competitive advantage over others.

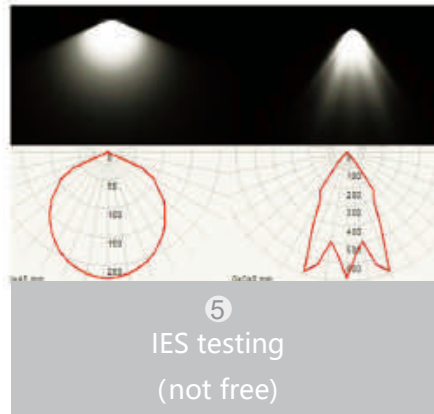

and so on...

We are always growing together with our customers.

LEDWIDE PMMA smoke diffuser with a special compound that allows to transmit light once the led is applied to it. It maintains 95% the tone of the monocolour or RGB led but absorbs a large amount of light (around 70%) so it is mainly intended for decorative and non-technical lighting. Combined with our black Led Profiles, with black covers and black clips, suspension kits, it allows to blend into surfaces dark obtaining spectacular and very elegant results.

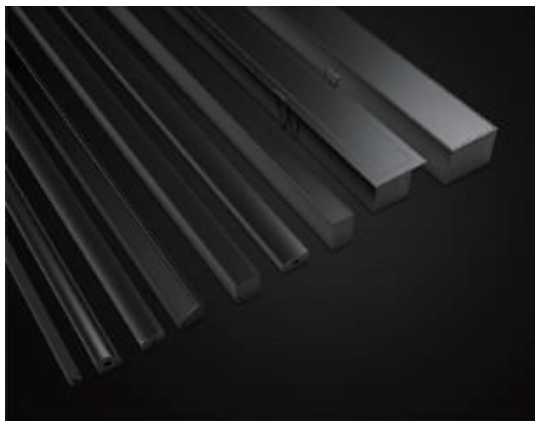

## SURFACE

● In Stock ● Few in Stock ● Not stocked or ordered in as requested, MOQ may apply



Model number	AS1	AS2	AS3	AS5	AS9	AS9-6 <small>NEW</small>	AST1
Pages	Page 20	Page 22	Page 24	Page 26	Page 28	Page 30	Page 20
Dimension (W x H)	17.1*8.5mm	17.1*15.2mm	23.5*10.9mm	15.9*6mm	8*9mm	8*6mm	17.1*13.7mm
Max. led power	14.4W/m	19.2W/m	19.2W/m	14.4W/m	9.6W/m	9.6W/m	14.4W/m
Stock	●	●	●	●	●	●	●
Max. length	6000mm	6000mm	6000mm	6000mm	4000mm	4000mm	6000mm

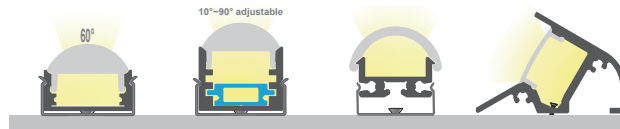

Model number	AL60	MD	AP2	AW7 <small>NEW</small>
Pages	Page 20	Page 32	Page 34	Page 36
Dimension (W x H)	17.1*12.8mm	17.1*17.8mm	16*15.4mm	36.7*25mm
Max. led power	14.4W/m	19.2W/m	19.2W/m	19.2W/m
Stock	●	●	●	●
Max. length	6000mm	4000mm	6000mm	6000mm

## RECESSED



Model number	AR1	AR2	AR3	AR5	WR2	AR9
Pages	Page 40	Page 42	Page 44	Page 46	Page 48	Page 50
Dimension (W x H)	23*8.5mm	23*15.2mm	30.6*10.9mm	15.2*6mm	23*19.2mm	14*9mm
Max. led power	14.4W/m	19.2W/m	19.2W/m	14.4W/m	19.2W/m	9.6W/m
Stock	●	●	●	●	●	●
Max. length	6000mm	6000mm	6000mm	4000mm	6000mm	4000mm



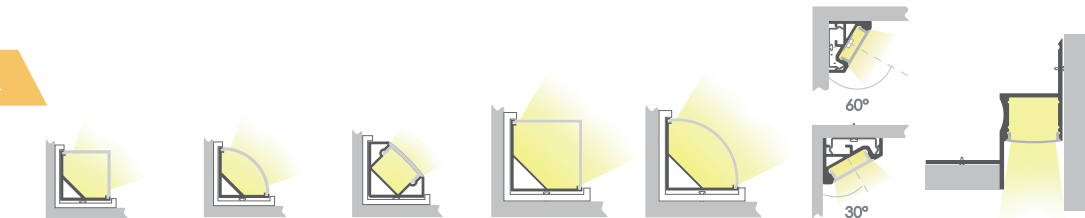

## CORNER





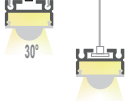

Model number	AC1	AC2	AC3	AC4	AC5	AV2	AT7N
Pages	Page 54	Page 54	Page 56	Page 58	Page 58	Page 60	Page 62
Dimension (W x H)	16*16mm	16*16mm	18.4*18.4mm	30*30mm	30*30mm	20*16mm	55.5*44.6mm
Max. led power	14.4W/m	14.4W/m	14.4W/m	19.2W/m	19.2W/m	9.6W/m	19.2W/m
Stock	●	●	●	●	●	●	●
Max. length	6000mm	6000mm	6000mm	6000mm	6000mm	6000mm	6000mm

# SURFACE & SUSPENSION

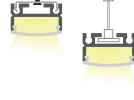
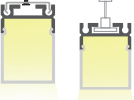

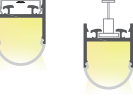
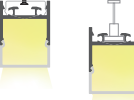

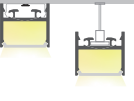
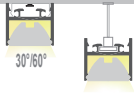

● In Stock ● Few in Stock ● Not stocked and ordered in as requested, MOQ may apply

					
Model number	US20	U20	AT4	AT5	AT6
Pages	Page 66	Page 68	Page 70	Page 70	Page 70
Dimension (W x H)	20*20mm	20*40mm	19.5*19.2mm	19.5*19.2mm	19.5*16.3mm
Max. led power	19.2W/m	19.2W/m	19.2W/m	19.2W/m	19.2W/m
Stock	●	●	●	●	●
Max. length	6000mm	6000mm	6000mm	6000mm	6000mm

					
Model number	AT11	AT5H	AT15-30 <b>NEW</b>	AT16-4 <b>UPGRADE</b>	AT16-5 <b>UPGRADE</b>
Pages	Page 72	Page 72	Page 74	Page 76	Page 76
Dimension (W x H)	19.5*12.5mm	19.5*28.4mm	25*29.7mm	19.5*26.3mm	19.5*25.9mm
Max. led power	19.2W/m	19.2W/m	19.2W/m	19.2W/m	19.2W/m
Stock	●	●	●	●	●
Max. length	6000mm	6000mm	6000mm	6000mm	6000mm

			
Model number	AT16-5H <b>UPGRADE</b>	AT16-11 <b>UPGRADE</b>	AT16-30-60
Pages	Page 76	Page 78	Page 78
Dimension (W x H)	19.5*35.4mm	19.5*17.4mm	19.5*17.4mm
Max. led power	19.2W/m	19.2W/m	28.8W/m
Stock	●	●	●
Max. length	6000mm	6000mm	6000mm

# WATERPROOF

						
Model number	WP2	AA	AB	AF1	AF2	AF3
Pages	Page 82	Page 84	Page 86	Page 88	Page 90	Page 92
Dimension (W x H)	17.1*17mm	19.1*8mm	28.6*11.2mm	26*25mm	30.5*30mm	69*65mm
Max. led power	14.4W/m	14.4W/m	14.4W/m	19.2W/m	19.2W/m	19.2W/m
Stock	●	●	●	●	●	●
Max. length	4000mm	4000mm	4000mm	6000mm	6000mm	6000mm

## STEP AND STAIR

● In Stock ● Few in Stock ● Not stocked and ordered in as requested, MOQ may apply



	ST1	ST2 <b>NEW</b>	STR3
Model number			
Pages	Page 96	Page 98	Page 100
Dimension (W x H)	67.5*27.8mm	60*25.7mm	82.4*37.9mm
Max. led power	19.2W/m	9.6W/m	19.2W/m
Stock	●	●	●
Max. length	6000mm	6000mm	6000mm

## ROUND



	R30	R34	R60
Model number			
Pages	Page 104	Page 106	Page 108
Dimension (W x H)	φ30	φ34	φ60
Max. led power	28.8W/m	28.8W/m	28.8W/m
Stock	●	●	●
Max. length	4000mm	5000mm	6000mm

## WALL

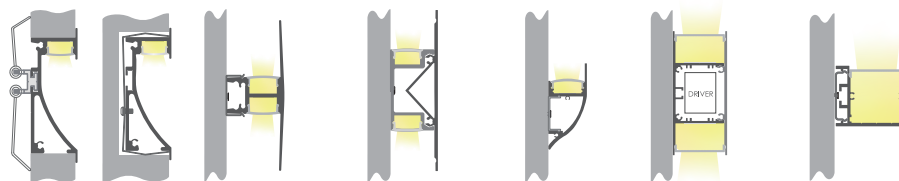

	AW 1	AW 2	AW 4-1	AW 8	AW 5-1	AW 35
Model number						
Pages	Page 112	Page 114	Page 116	Page 118	Page 120	Page 122
Dimension (W x H)	25.4*70mm	27.7*70mm	23.6*83mm	17.5*40.7mm	35*83mm	42*35mm
Max. led power	19.2W/m	14.4W/m	14.4W/m	19.2W/m	19.2W/m	38.4W/m
Stock	●	●	●	●	●	●
Max. length	6000mm	6000mm	4000mm	4000mm	4000mm	6000mm

## DRIVER BUILT-IN PROFILE

● In Stock   ● Few in Stock   ● Not stocked and ordered in as requested, MOQ may apply

Remark :3 different installation ways as P35

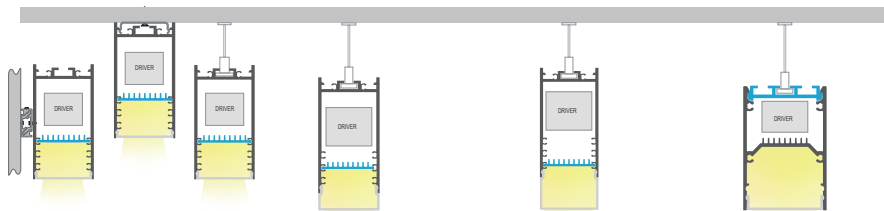

Model number	P35	PU35	PUH35	P46
Pages	Page 126	Page 126	Page 126	Page 128
Dimension (W x H)	35*68mm	35*78mm	35*88mm	46*68mm
Max. led power	38.4W/m	38.4W/m	38.4W/m	38.4W/m
Stock	●	●	●	●
Max. length	6000mm	6000mm	6000mm	6000mm

Remark :3 different installation ways as P35

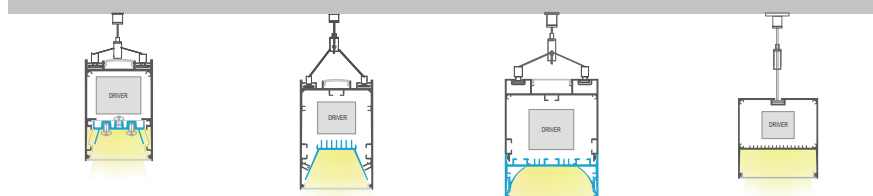

Model number	P50N <sup>UPGRADE</sup>	P60	EH80	P74
Pages	Page 130	Page 132	Page 134	Page 136
Dimension (W x H)	50*75mm	60*90mm	80*100mm	74*77mm
Max. led power	57.6W/m	57.6W/m	57.6W/m	57.6W/m
Stock	●	●	●	●
Max. length	6000mm	6000mm	6000mm	6000mm

## TRIMLESS-ARCHITECTURAL

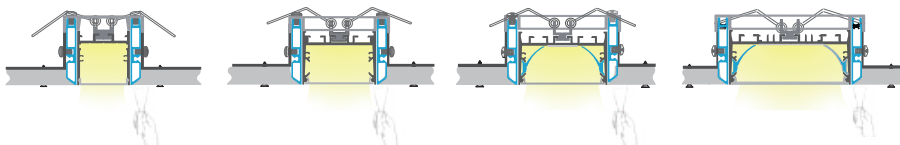

Model number	TR35	TR50	TR60	TR80
Pages	Page 140	Page 142	Page 144	Page 146
Dimension (W x H)	54*48mm	67*48mm	76*48mm	96*48mm
Max. led power	28.8W/m	38.4W/m	57.6W/m	57.6W/m
Stock	●	●	●	●
Max. length	6000mm	6000mm	6000mm	6000mm

# SURFACE & SUSPENSION-ARCHITECTURAL

● In Stock

● Few in Stock

● Not stocked and ordered in as requested, MOQ may apply

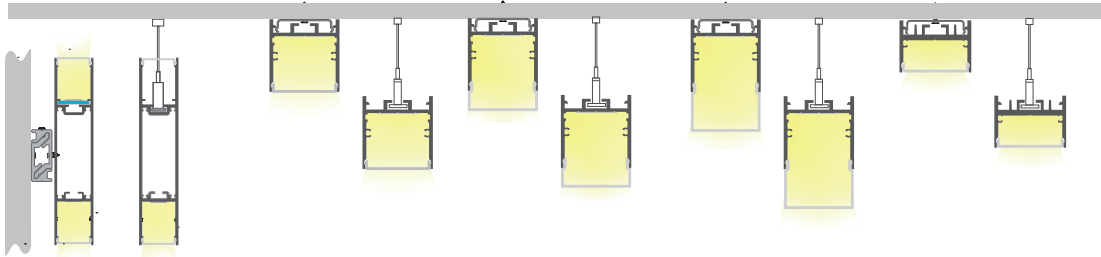

Model number	P24 <span style="color:red">NEW</span>	WN35	WU35	WUH35	WN35-25
Pages	Page 150	Page 152	Page 152	Page 152	Page 154
Dimension (W x H)	25*120mm	35*37.5mm	35*47.5mm	35*57.5mm	35*25.4mm
Max. led power	38.4*2W/m	38.4W/m	38.4W/m	38.4W/m	38.4W/m
Stock	●	●	●	●	●
Max. length	4000mm	6000mm	6000mm	6000mm	6000mm

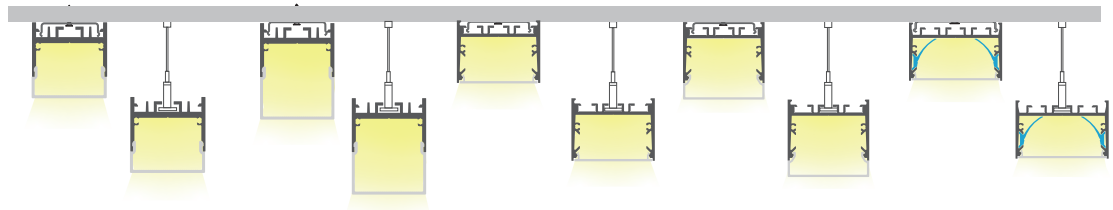

Model number	WU35-25	WUH35-25	E50	EU50	E60
Pages	Page 154	Page 154	Page 156	Page 156	Page 158
Dimension (W x H)	35*35.4mm	35*45.4mm	50*37.5mm	50*47.5mm	60*37.5mm
Max. led power	38.4W/m	38.4W/m	38.4W/m	57.6W/m	57.6W/m
Stock	●	●	●	●	●
Max. length	6000mm	6000mm	6000mm	6000mm	6000mm

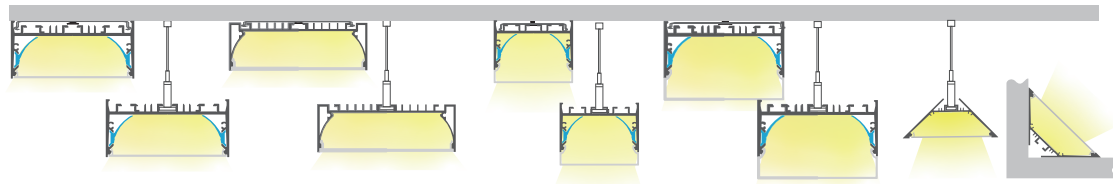

Model number	E80	E100	EU60	EU80	W91
Pages	Page 160	Page 162	Page 158	Page 160	Page 164
Dimension (W x H)	80*37.5mm	102*31mm	60*47.5mm	80*52.5mm	90*37.5mm
Max. led power	57.6W/m	57.6W/m	57.6W/m	57.6W/m	57.6W/m
Stock	●	●	●	●	●
Max. length	6000mm	4000mm	6000mm	6000mm	6000mm



## RECESSED-ARCHITECTURAL

● In Stock ● Few in Stock ● Not stocked and ordered in as requested, MOQ may apply

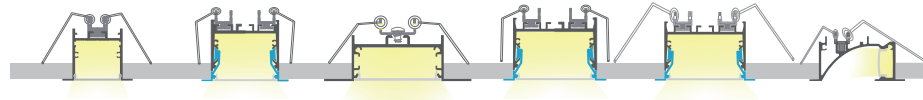

Model number	WN31	ER50	ER50-2 <sup>NEW</sup>	ER60	ER7635	AW 1-50 <sup>NEW</sup>
Pages	Page 168	Page 170	Page 174	Page 172	Page 176	Page 178
Dimension (W x H)	49*37.5mm	63.9*45mm	80*25mm	73.9*45mm	91*35mm	19.5*50mm
Max. led power	38.4W/m	57.6W/m	38.4W/m	57.6W/m	57.6W/m	19.2W/m
Stock	●	●	●	●	●	●
Max. length	6000mm	5000mm	6000mm	5000mm	4000mm	6000mm

## PLASTER IN TRIMLESS

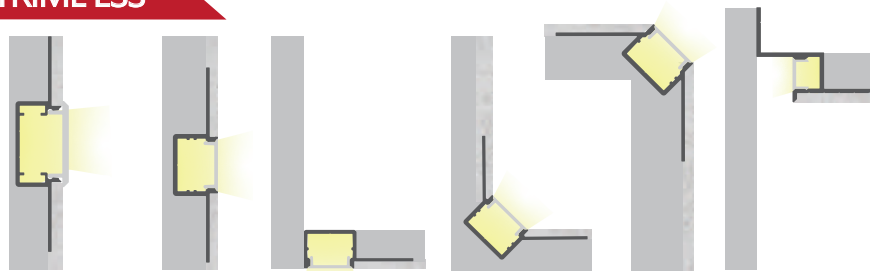

Model number	CT4N	CT5	CT5S	CT6	CT7	CT8
Pages	Page 182	Page 184	Page 186	Page 188	Page 190	Page 192
Dimension (W x H)	66.4*16.4mm	59*13.6mm	38.8*13.6mm	49.8*26.1mm	55.6*23.7mm	42.5*28.5mm
Max. led power	19.2W/m	19.2W/m	19.2W/m	19.2W/m	19.2W/m	19.2W/m
Stock	●	●	●	●	●	●
Max. length	2500mm	2500mm	2500mm	2500mm	2500mm	2500mm

## BEND & CURVED

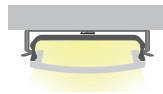

Model number	B1
Pages	Page 200
Dimension (W x H)	19.4*6.5mm
Max. led power	14.4W/m
Stock	●
Max. length	3000mm

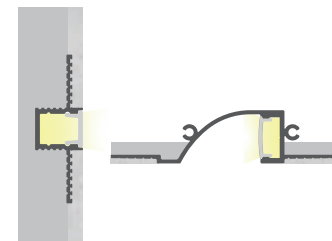

Model number	CT9 <sup>NEW</sup>	CTW1 <sup>NEW</sup>
Pages	Page 194	Page 196
Dimension (W x H)	28*9mm	86.5*16mm
Max. led power	9.6W/m	14.4W/m
Stock	●	●
Max. length	2500mm	6000mm

# Catalogue

## **1 SURFACE**

3 CORNER

5 WATERPROOF

7 ROUND

9 DRIVER BUILT-IN PROFILE

11 SURFACE & SUSPENSION-ARCHITECTURAL

13 PLASTER IN TRIMLESS

2 RECESSED

4 SURFACE & SUSPENSION

6 STEP AND STAIR

8 WALL

10 TRIMLESS-ARCHITECTURAL

12 RECESSED-ARCHITECTURAL

14 BEND & CURVED

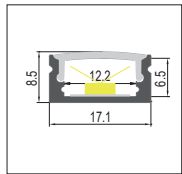

LW-AS1  
Page 20

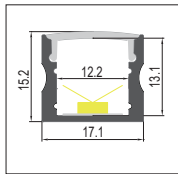

LW-AS2  
Page 22

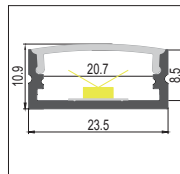

LW-AS3  
Page 24

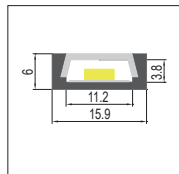

LW-AS5  
Page 26

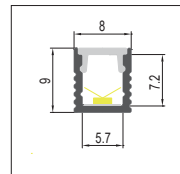

LW-AS9  
Page 28

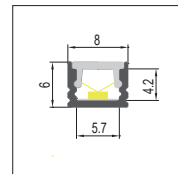

LW-AS9-6  
Page 30

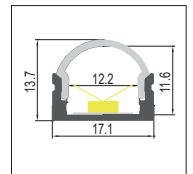

LW-AST1  
Page 20

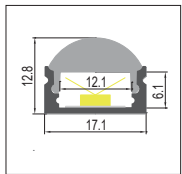

LW-AL60  
Page 20

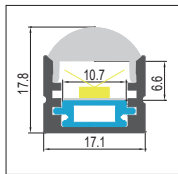

LW-MD  
Page 32

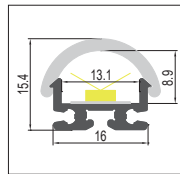

LW-AP2  
Page 34

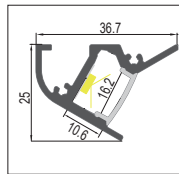

LW-AW7  
Page 36

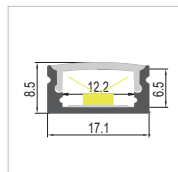

LW-AS1

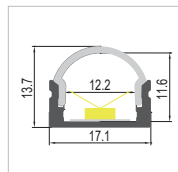

LW-AST1

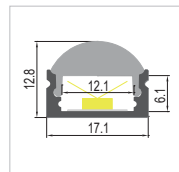

LW-AL60

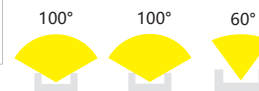

## Aluminium Profile

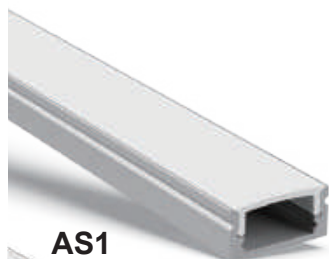

AS1



AST1



AL60

### Specification:

Suitable for PCB:	12mm
Max. LED power:	14.4w/m
Installation:	Surface
Material:	Extruded Aluminium 6063
Finish:	Silver anodised, Black or White *
Diffuser:	PMMA flexible diffuser, can be 25m continuous rolled
Length:	2000mm or 2500mm continuous **
Size:	Profile (W) 17.1mm, (H) 8.5mm
Driver installation:	Remote driver required

\* Custom powder coated colour upon request. Surcharge apply.  
 \*\* Profile sold per metre. Can be cut to suit any length up to 6000mm.



#### PMMA Diffuser

- Code: AS1-O (Opal, light trans. >52%)
- Code: AS1-M (Milky, light trans. >65%)
- Code: AS1-F (Frost, light trans. >81%)
- Code: AS1-C (Clear, light trans. >95%)

#### PC Diffuser

- Code: AS1-O (Opal, light trans. >50%)

#### PMMA Diffuser

- Code: AST1-M (Milky, light trans. >65%)

#### PC Diffuser

- Code: AL60-C (Clear, light trans. >94%)

#### Black Diffuser

- Code: AS1-B (Black, light trans. >22%)
- MOQ: 200M

## Installing accessories:



**Plastic Endcap**  
(with/without hole)  
Code: AS1-Cap  
Code: AS1-Cap-H



**Metal Clip**  
Code: AS1-Clip-M



**Plastic Endcap**  
(with/without hole)  
Code: AL60-Cap  
Code: AL60-Cap-H



(Optional)

**Plastic Clip**  
Code: AS1-Clip-P



**Plastic Endcap**  
(with/without hole)  
Code: AST1-Cap  
Code: AST1-CapH



(Optional)

**Adjustable Clip**  
(0-222° rotation)  
Code: AS1-Clip-A



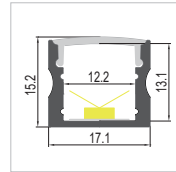

LW-AS2



## Aluminium Profile



AS2



### PMMA Diffuser

- Code: AS2-O (Opal, light trans. >52%)
- Code: AS2-M (Milky, light trans. >65%)
- Code: AS2-F (Frost, light trans. >81%)
- Code: AS2-C (Clear, light trans. >95%)

### PC Diffuser

- Code: AS1-O (Opal, light trans. >50%)



### Black Diffuser

- Code: AS2-B (Black, light trans. > 22%)
- MOQ: 200M

### Specification:

Suitable for PCB:	12mm
Max. LED power:	19.2w/m
Installation:	Surface
Material:	Extruded Aluminium 6063
Finish:	Silver anodised, Black or White *
Diffuser:	PMMA flexible diffuser, can be 25m continuous rolled
Length:	2000mm or 2500mm continuous **
Size:	Profile (W) 17.1mm, (H) 15.2mm
Driver installation:	Remote driver required

\* Custom powder coated colour upon request. Surcharge apply.

\*\* Profile sold per metre. Can be cut to suit any length up to 6000mm.

## Installing accessories:



**Plastic Endcap** Code: AS2-Cap  
(with/without hole) Code: AS2-Cap-H



**Metal Clip**  
Code: AS1-Clip-M



(Optional)

**Adjustable Clip**  
(0-222° rotation) Code: AS1-Clip-A



(Optional)

**Plastic Clip**  
Code: AS1-Clip-P

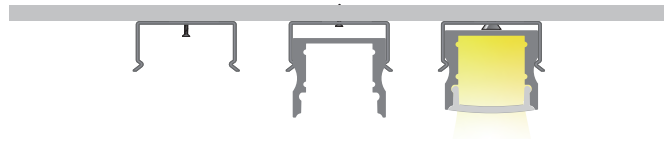

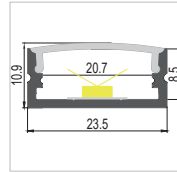

LW-AS3



## Aluminium Profile



AS3

### Specification:

Suitable for PCB :	20mm
Max. LED power:	19.2w/m
Installation:	Surface
Material:	Extruded Aluminium 6063
Finish:	Silver anodised, Black or White *
Diffuser:	PMMA flexible diffuser, can be 25m continuous rolled
Length:	2000mm or 2500mm continuous **
Size:	Profile (W) 23.5mm, (H) 10.9mm
Driver installation:	Remote driver required
* Custom powder coated colour upon request. Surcharge apply.	
** Profile sold per metre. Can be cut to suit any length up to 6000mm.	



#### PMMA Diffuser

Code: AS3-O (Opal, light trans. >52%)

Code: AS3-F (Frost, light trans. >81%)

Code: AS3-C (Clear, light trans. >95%)



#### Black Diffuser

Code: AS3-B (Black, light trans. > 22%)

MOQ: 200M



## Installing accessories:



**Plastic Endcap**  
(with/without hole) Code: AS3-Cap  
Code: AS3-Cap-H



**Metal Clip**  
Code: AS3-Clip-M



(Optional)

**Adjustable Clip**  
(0-222° rotation) Code: AS3-Clip-A



(Optional)

**Plastic Clip**  
Code: AS3-Clip-P

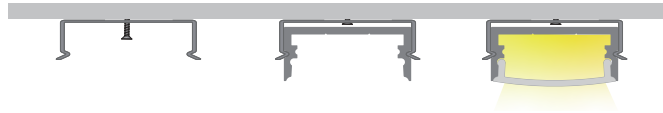

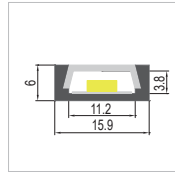

LW-AS5



## Aluminium Profile



AS5

### Specification:

Suitable for PCB: 10mm

Max. LED power: 14.4w/m

Installation: Surface

Material: Extruded Aluminium 6063

Finish: Silver anodised, Black or White \*

Diffuser: PC flexible diffuser

Length: 2000mm or 2500mm continuous \*\*

Size: Profile (W) 15.9mm, (H) 6mm

Driver installation: Remote driver required

\* Custom powder coated colour upon request. Surcharge apply.

\*\* Profile sold per metre. Can be cut to suit any length up to 6000mm.



#### PC Diffuser

Code: AS5-O (Opal, light trans. >50%)

Code: AS5-F (Frost, light trans. >65%)

## Installing accessories:



**Plastic Endcap**  
(with/without hole) Code: AS5-Cap  
Code: AS5-Cap-H



**Metal Clip**  
Code: AS5-Clip-M



(Optional)

**Adjustable Clip**  
(0-222° rotation) Code: AS5-Clip-A



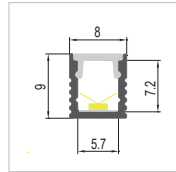
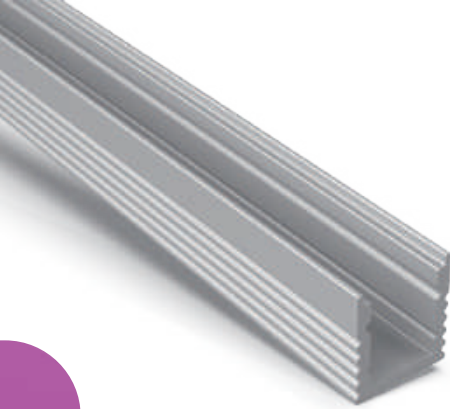

LW-AS9



## Aluminium Profile

### Specification:

Suitable for PCB:	5mm
Max. LED power:	9.6w/m
Installation:	Surface
Material:	Extruded Aluminium 6063
Finish:	Silver anodised, Black or White *
Diffuser:	PC flexible diffuser
Length:	2000mm or 2500mm continuous **
Size:	Profile (W) 8mm, (H) 9mm
Driver installation:	Remote driver required

\* Custom powder coated colour upon request. Surcharge apply.

\*\* Profile sold per metre. Can be cut to suit any length up to 4000mm.

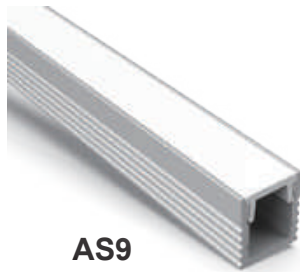

AS9



#### PC Diffuser

Code: AS9-O (Opal, light trans. >50%)  
Code: AS9-C (Clear, light trans. >94%)



#### Black Diffuser

Code: AS9-B (Black, light trans. >22%)  
MOQ: 200M

For 2110 120led 4mm 7.2W strip only.

## Installing accessories:



**Plastic Endcap** Code: AS9-Cap  
(with/without hole) Code: AS9-Cap-H



**Metal Clip**  
Code: AS9-Clip-M

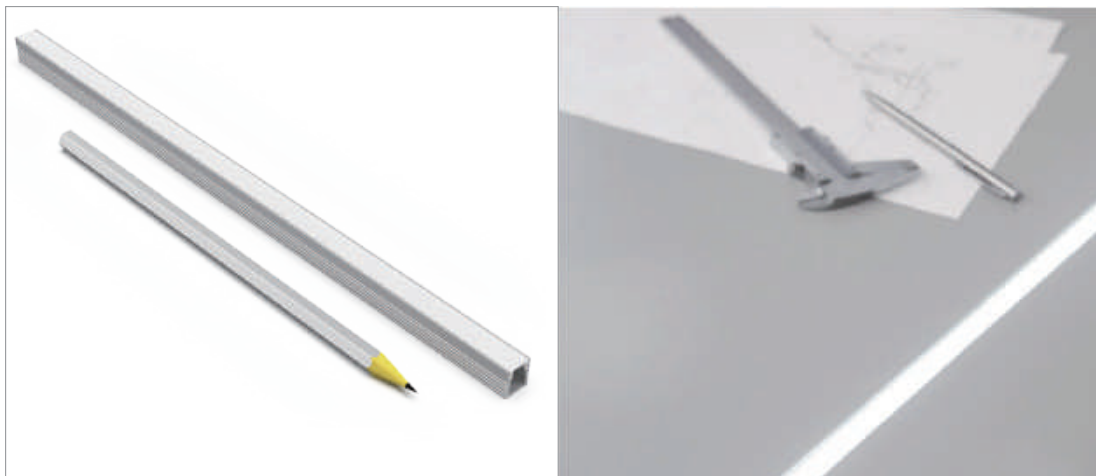
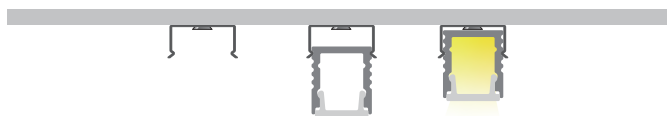

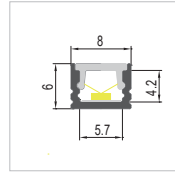
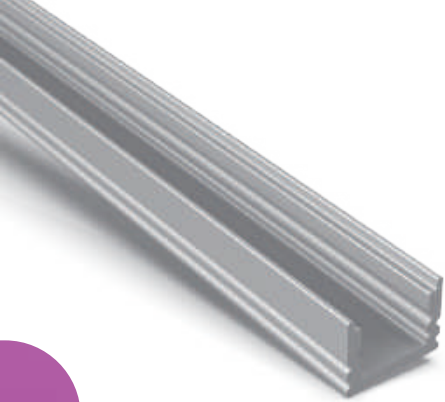

LW-AS9-6



## Aluminium Profile

### Specification:

Suitable for PCB:	5mm
Max. LED power:	9.6w/m
Installation:	Surface
Material:	Extruded Aluminium 6063
Finish:	Silver anodised, Black or White *
Diffuser:	PC flexible diffuser
Length:	2000mm or 2500mm continuous **
Size:	Profile (W) 8mm, (H) 6mm
Driver installation:	Remote driver required

\* Custom powder coated colour upon request. Surcharge apply.

\*\* Profile sold per metre. Can be cut to suit any length up to 4000mm.

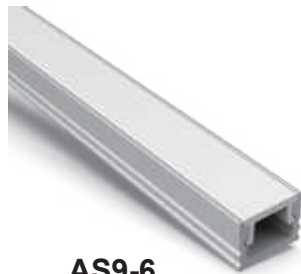

AS9-6



#### PC Diffuser

Code: AS9-6-O (Opal, light trans. >50%)  
Code: AS9-6-C (Clear, light trans. >94%)



For 2110 120led 4mm 7.2W strip only.

## Installing accessories:



**Plastic Endcap** Code: AS9-6-Cap  
(with/without hole) Code: AS9-6-Cap-H



Only 6mm height, SMALLEST in Ledwide profiles range

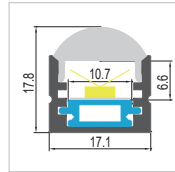

LW-MD

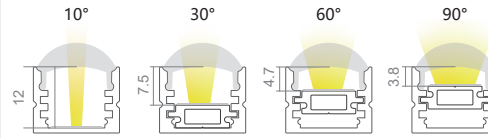

## Aluminium Profile



MD



**PC Diffuser**  
Code: MD-C (Clear, light trans. >94%)

### Specification:

Suitable for PCB:	10mm
Max. LED power:	19.2w/m
Installation:	Surface
Material:	Extruded Aluminium 6063
Finish:	Silver anodised, Black or White *
Diffuser:	PC flexible diffuser
Length:	2000mm or 2500mm continuous **
Size:	Profile (W) 17.1mm, (H) 17.8mm
Driver installation:	Remote driver required

\* Custom powder coated colour upon request. Surcharge apply.

\*\* Profile sold per metre. Can be cut to suit any length up to 4000mm.



## Installing accessories:



**Plastic Endcap**  
(with/without hole) Code: MD-Cap  
Code: MD-Cap-H



**Metal Clip**  
Code: AS1-Clip-M



(Optional)

**Adjustable Clip**  
(0-222° rotation) Code: AS1-Clip-A



(Optional)

**Plastic Clip**  
Code: AS1-Clip-P

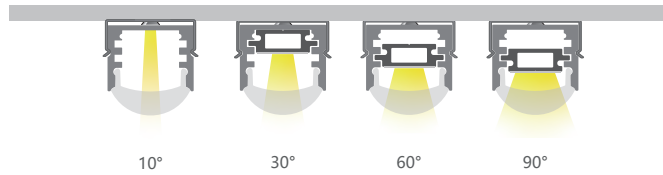

10°

30°

60°

90°

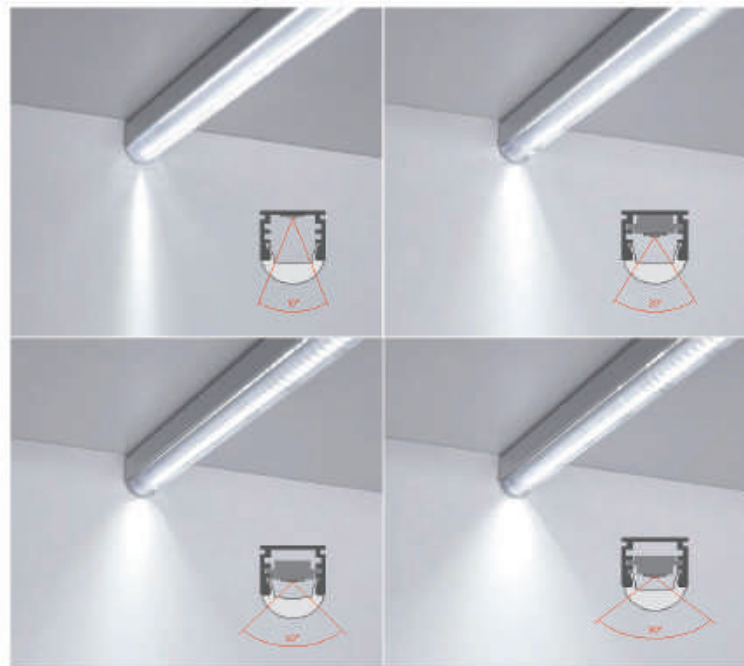

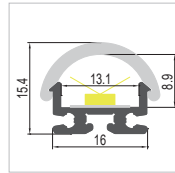

LW-AP2



## Aluminium Profile



AP2



### PC Diffuser

Code: AP2-O (Opal, light trans. >50%)

### Specification:

Suitable for PCB:	12mm
Max. LED power:	19.2w/m
Installation:	Surface
Material:	Extruded Aluminium 6063
Finish:	Silver anodised, Black or White *
Diffuser:	PC flexible diffuser
Length:	2000mm or 2500mm continuous **
Size:	Profile (W) 16mm, (H) 15.4mm
Driver installation:	Remote driver required
* Custom powder coated colour upon request. Surcharge apply.	
** Profile sold per metre. Can be cut to suit any length up to 6000mm.	

## Installing accessories:



**Aluminium Endcap** Code: AP2-Cap  
(with/without hole) Code: AP2-Cap-H



**Metal Clip**  
Code: AP2-Clip-M



(Optional)

**Adjustable Clip**  
(0-222° rotation) Code: AP2-Clip-A

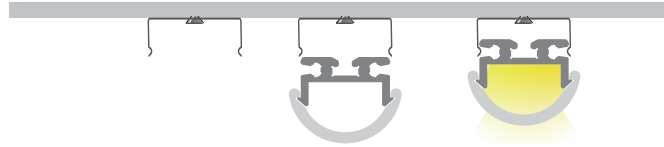

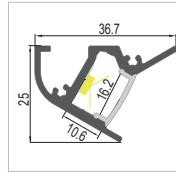

LW-AW7



## Aluminium Profile

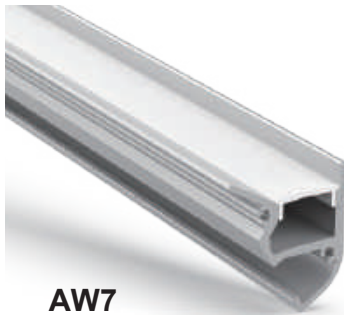

AW7

### Specification:

Suitable for PCB:	15mm
Max. LED power:	19.2w/m
Installation:	Surface mounted
Material:	Extruded Aluminium 6063
Finish:	Silver anodised, Black or White*
Diffuser:	PPMMA flexible diffuser, can be 25m continuous rolled
Length:	2000mm or 2500mm continuous**
Size:	Profile (W) 36.7mm, (H) 25mm
Driver installation:	Remote driver required
* Custom powder coated colour upon request. Surcharge apply.	
** Profile sold per metre. Can be cut to suit any length up to 6000mm.	



#### PMMA Diffuser

- Code: AW7-O (Opal, light trans. >52%)
- Code: AW7-M (Milky, light trans. >65%)
- Code: AW7-F (Frost, light trans. >81%)
- Code: AW7-C (Clear, light trans. >95%)

#### PC Diffuser

- Code: AW7-O (Opal, light trans. >50%)

## Installing accessories:



**Aluminium CNC Endcap**  
(without hole)

Code: AW7-Cap-R  
Code: AW7-Cap-L

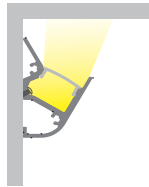

Ceiling Wash

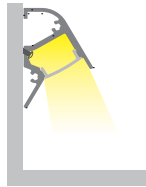

Floor Wash

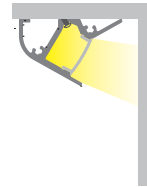

Wall Wash



# Catalogue

- |    |                                    |    |                        |
|----|------------------------------------|----|------------------------|
| 1  | SURFACE                            | 2  | <b>RECESSED</b>        |
| 3  | CORNER                             | 4  | SURFACE & SUSPENSION   |
| 5  | WATERPROOF                         | 6  | STEP AND STAIR         |
| 7  | ROUND                              | 8  | WALL                   |
| 9  | DRIVER BUILT-IN PROFILE            | 10 | TRIMLESS-ARCHITECTURAL |
| 11 | SURFACE & SUSPENSION-ARCHITECTURAL | 12 | RECESSED-ARCHITECTURAL |
| 13 | PLASTER IN TRIMLESS                | 14 | BEND & CURVED          |

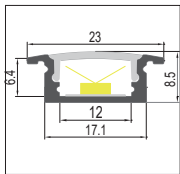

LW-AR1  
Page 40

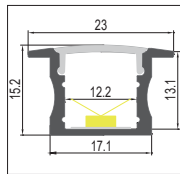

LW-AR2  
Page 42

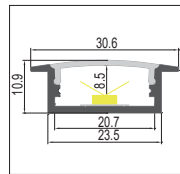

LW-AR3  
Page 44

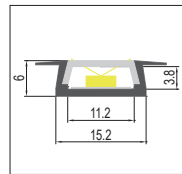

LW-AR5  
Page 46

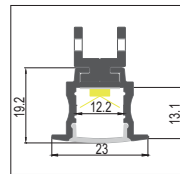

LW-WR2  
Page 48

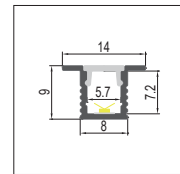

LW-AR9  
Page 50

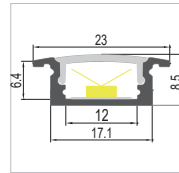
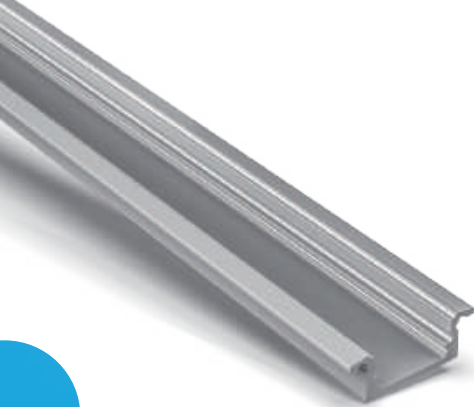

LW-AR1



## Aluminium Profile

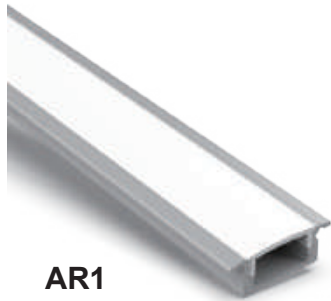

AR1

### Specification:

Suitable for PCB	12mm
Max. LED power:	14.4w/m
Installation:	Recessed
Material:	Extruded Aluminium 6063
Finish:	Silver anodised, Black or White *
Diffuser:	PMMA flexible diffuser, can be 25m continuous rolled
Length:	2000mm or 2500mm continuous **
Size:	Profile (W) 23mm, (H) 6.4mm
Driver installation:	Remote driver required
* Custom powder coated colour upon request. Surcharge apply.	
** Profile sold per metre. Can be cut to suit any length up to 6000mm.	



#### PMMA Diffuser

- Code: AR1-O (Opal, light trans. >52%)
- Code: AR1-M (Milky, light trans. >65%)
- Code: AR1-F (Frost, light trans. >81%)
- Code: AR1-C (Clear, light trans. >95%)

#### PC Diffuser

- Code: AR1-O (Opal, light trans. >50%)



## Installing accessories:



**Plastic Endcap** Code: AR1-Cap  
(with/without hole) Code: AR1-Cap-H



**Metal Clip**  
Code: AS1-Clip-M



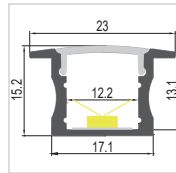

LW-AR2



## Aluminium Profile

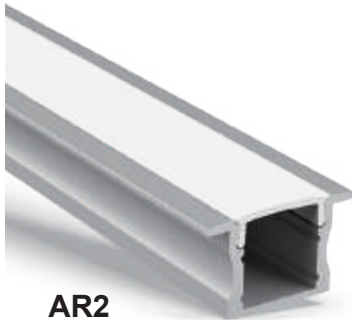

AR2

### Specification:

Suitable for PCB	12mm
Max. LED power:	19.2w/m
Installation:	Recessed
Material:	Extruded Aluminium 6063
Finish:	Silver anodised, Black or White *
Diffuser:	PMMA flexible diffuser, can be 25m continuous rolled
Length:	2000mm or 2500mm continuous **
Size:	Profile (W) 23mm, (H) 15.2mm
Driver installation:	Remote driver required
* Custom powder coated colour upon request. Surcharge apply.	
** Profile sold per metre. Can be cut to suit any length up to 6000mm.	



#### PMMA Diffuser

- Code: AR2-O (Opal, light trans. >52%)
- Code: AR2-M (Milky, light trans. >65%)
- Code: AR2-F (Frost, light trans. >81%)
- Code: AR2-C (Clear, light trans. >95%)

#### PC Diffuser

- Code: AR2-O (Opal, light trans. >50%)

## Installing accessories:



**Plastic Endcap**  
(with/without hole) Code: AR2-Cap  
Code: AR2-Cap-H



**Metal Clip**  
Code: AS1-Clip-M



(Optional)

**Plastic Clip**  
Code: AS1-Clip-P



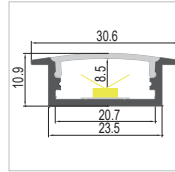
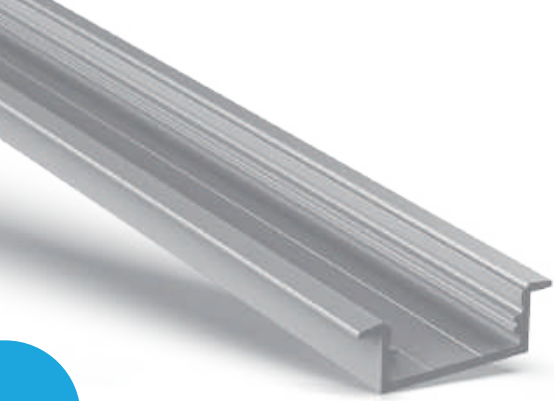

LW-AR3



## Aluminium Profile

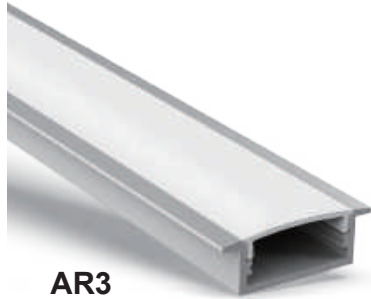

AR3



### PMMA Diffuser

- Code: AR3-O (Opal, light trans. >52%)
- Code: AR3-F (Frost, light trans. >81%)
- Code: AR3-C (Clear, light trans. >95%)

### Specification:

Suitable for PCB	20mm
Max. LED power:	19.2w/m
Installation:	Recessed
Material:	Extruded Aluminium 6063
Finish:	Silver anodised, Black or White *
Diffuser:	PMMA flexible diffuser, can be 25m continuous rolled
Length:	2000mm or 2500mm continuous **
Size:	Profile (W) 30.6mm, (H) 10.9mm
Driver installation:	Remote driver required

\* Custom powder coated colour upon request. Surcharge apply.

\*\* Profile sold per metre. Can be cut to suit any length up to 6000mm.

## Installing accessories:



**Plastic Endcap** Code: AR3-Cap  
(with/without hole) Code: AR3-Cap-H



**Metal Clip**  
Code: AS3-Clip-M



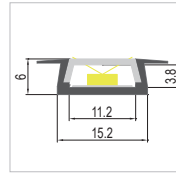

LW-AR5



## Aluminium Profile

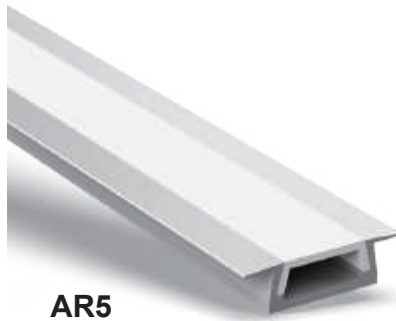

AR5

### Specification:

Suitable for PCB 10mm	
Max. LED power:	14.4w/m
Installation:	Recessed
Material:	Extruded Aluminium 6063
Finish:	Silver anodised, Black or White *
Diffuser:	PC flexible diffuser
Length:	2000mm or 2500mm continuous **
Size:	Profile (W) 15.2mm, (H) 6mm
Driver installation: Remote driver required	
* Custom powder coated colour upon request. Surcharge apply.	
** Profile sold per metre. Can be cut to suit any length up to 4000mm.	



#### PC Diffuser

Code: AR5-O (Opal, light trans. >50%)  
 Code: AR5-F (Frost, light trans. >65%)

## Installing accessories:



**Plastic Endcap**  
(with/without hole) Code: AR5-Cap  
Code: AR5-Cap-H



**Metal Clip**  
Code: AS5-Clip-M



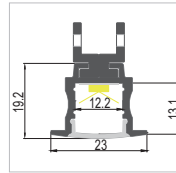

LW-WR2



## Aluminium Profile



WR2

### Specification:

Suitable for PCB 12mm

Max. LED power: 19.2w/m

Installation: Recessed

Material: Extruded Aluminium 6063

Finish: Silver anodised, Black or White \*

Diffuser: PMMA flexible diffuser, can be 25m continuous rolled

Length: 2000mm or 2500mm continuous \*\*

Size: Profile (W) 23mm, (H) 19.2mm

Driver installation: Remote driver required

\* Custom powder coated colour upon request. Surcharge apply.

\*\* Profile sold per metre. Can be cut to suit any length up to 6000mm.

#### PMMA Diffuser

Code: WR2-O (Opal, light trans. >52%)

Code: WR2-M (Milky, light trans. >65%)

Code: WR2-F (Frost, light trans. >81%)

Code: WR2-C (Clear, light trans. >95%)

#### PC Diffuser

Code: WR2-O (Opal, light trans. >50%)





## Installing accessories:



**Plastic Endcap**  
(with/without hole) Code: AR2-Cap  
Code: AR2-Cap-H



**Spring Clip**  
Code: SC-AW6

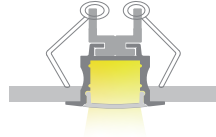

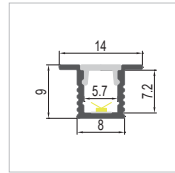
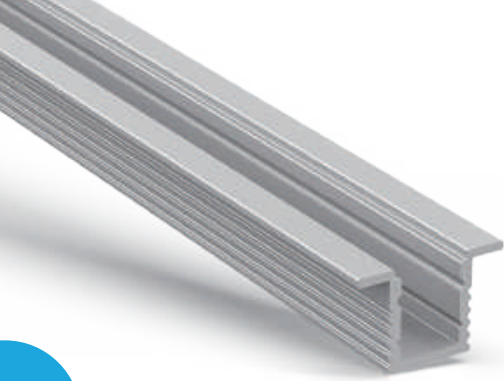

LW-AR9



## Aluminium Profile



AR9



### Specification:

Suitable for PCB 5mm

Max. LED power: 9.6w/m

Installation: Recessed

Material: Extruded Aluminium 6063

Finish: Silver anodised, Black or White \*

Diffuser: PC flexible diffuser

Length: 2000mm or 2500mm continuous \*\*

Size: Profile (W) 14mm, (H) 9mm

Driver installation: Remote driver required

\* Custom powder coated colour upon request. Surcharge apply.

\*\* Profile sold per metre. Can be cut to suit any length up to 4000mm.



#### PC Diffuser

Code: AR9-O (Opal, light trans. >50%)

Code: AR9-C (Clear, light trans. >94%)

For 2110 120led 4mm 7.2W strip only.

## Installing accessories:



**Plastic Endcap**  
(with/without hole) Code: AR9-Cap  
Code: AR9-Cap-H



**Metal Clip**  
Code: AS9-Clip-M



# Catalogue

- |    |                                    |    |                        |
|----|------------------------------------|----|------------------------|
| 1  | SURFACE                            | 2  | RECESSED               |
| 3  | <b>CORNER</b>                      | 4  | SURFACE & SUSPENSION   |
| 5  | WATERPROOF                         | 6  | STEP AND STAIR         |
| 7  | ROUND                              | 8  | WALL                   |
| 9  | DRIVER BUILT-IN PROFILE            | 10 | TRIMLESS-ARCHITECTURAL |
| 11 | SURFACE & SUSPENSION-ARCHITECTURAL | 12 | RECESSED-ARCHITECTURAL |
| 13 | PLASTER IN TRIMLESS                | 14 | BEND & CURVED          |

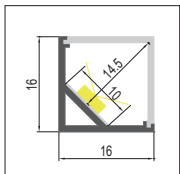

LW-AC1  
Page 54

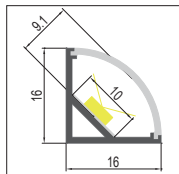

LW-AC2  
Page 54

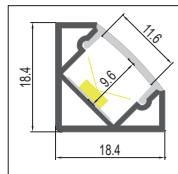

LW-AC3  
Page 56

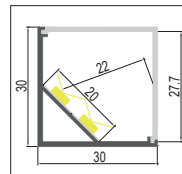

LW-AC4  
Page 58

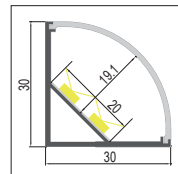

LW-AC5  
Page 58

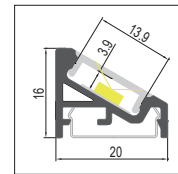

LW-AV2  
Page 60

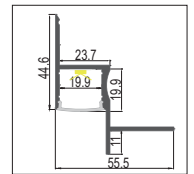

LW-AT7N  
Page 62

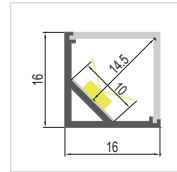

LW-AC1

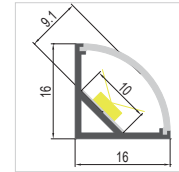

LW-AC2



120°

### Specification:

Suitable for PCB	10mm
Max. LED power:	14.4w/m
Installation:	Corner mounted
Material:	Extruded Aluminium 6063
Finish:	Silver anodised, Black or White *
Diffuser:	PMMA flexible diffuser
Length:	2000mm or 2500mm continuous **
Size:	Profile (W) 16mm, (H) 16mm
Driver installation:	Remote driver required
* Custom powder coated colour upon request. Surcharge apply.	
** Profile sold per metre. Can be cut to suit any length up to 6000mm.	

## Aluminium Profile



AC1



AC2



#### PMMA Diffuser

Code: AC1-O (Opal, light trans. >52%)  
Code: AC1-F (Frost, light trans. >81%)



#### PMMA Diffuser

Code: AC2-O (Opal, light trans. >42%)  
Code: AC2-M (Milky, light trans. >49%)  
Code: AC2-F (Frost, light trans. >54%)  
Code: AC2-C (Clear, light trans. >95%)

#### PC Diffuser

Code: AC2-O (Opal, light trans. >50%)



#### Black Diffuser

Code: AC2-B (Black, light trans. > 22%)  
MOQ: 200M

## Installing accessories:



**Plastic Endcap**  
(with/without hole) Code: AC1-Cap  
Code: AC1-Cap-H



**Metal Clip**  
Code: AC1-Clip-M



**Plastic Endcap**  
(with/without hole) Code: AC2-Cap  
Code: AC2-Cap-H



**Plastic Clip**  
Code: AC1-Clip-P



**Adjustable Clip**  
(0-222° rotation) Code: AC1-Clip-A

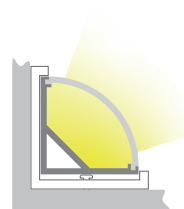
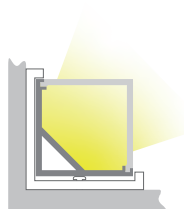

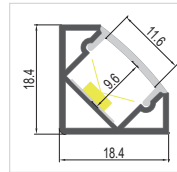

LW-AC3



**Specification:**

Suitable for PCB	10mm
Max. LED power:	14.4w/m
Installation:	Corner mounted
Material:	Extruded Aluminium 6063
Finish:	Silver anodised, Black or White *
Diffuser:	PMMA flexible diffuser, can be 25m continuous rolled
Length:	2000mm or 2500mm continuous **
Size:	Profile (W) 18.4mm, (H) 18.4mm
Driver installation:	Remote driver required
* Custom powder coated colour upon request. Surcharge apply.	
** Profile sold per metre. Can be cut to suit any length up to 6000mm.	

**Aluminium Profile**



AC3



**PMMA Diffuser**

- Code: AC3-O (Opal, light trans. >52%)
- Code: AC3-M (Milky, light trans. >65%)
- Code: AC3-F (Frost, light trans. >81%)
- Code: AC3-C (Clear, light trans. >95%)

**PC Diffuser**

- Code: AC3-O (Opal, light trans. >50%)



**Black Diffuser**

- Code: AS1-B (Black, light trans. > 22%)
- MOQ: 200M



## Installing accessories:



**Plastic Endcap**  
(with/without hole) Code: AC3-Cap  
Code: AC3-Cap-H



**Metal Clip**  
Code: AC3-Clip-M



(Optional)

**Adjustable Clip**  
(0-222° rotation) Code: AC3-Clip-A



(Optional)

**Plastic Clip**  
Code: AC3-Clip-P

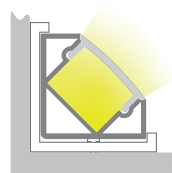
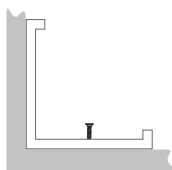

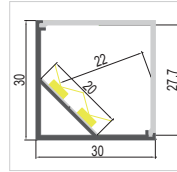

LW-AC4

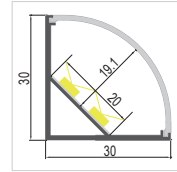

LW-AC5



## Aluminium Profile

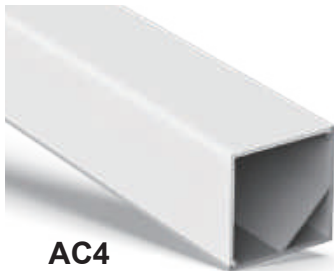

AC4



AC5

### Specification:

Suitable for PCB	20mm
Max. LED power:	19.2w/m
Installation:	Corner mounted
Material:	Extruded Aluminium 6063
Finish:	Silver anodised, Black or White *
Diffuser:	PC flexible diffuser
Length:	2000mm or 2500mm continuous **
Size:	Profile (W) 30mm, (H) 30mm
Driver installation:	Remote driver required

\* Custom powder coated colour upon request. Surcharge apply.

\*\* Profile sold per metre. Can be cut to suit any length up to 6000mm.



#### PC Diffuser

Code: AC4-O (Opal, light trans. >50%)

Code: AC4-C (Clear, light trans. >94%)



#### PC Diffuser

Code: AC5-O (Opal, light trans. >50%)

Code: AC5-C (Clear, light trans. >94%)

## Installing accessories:



**Plastic Endcap**  
(with/without hole) Code: AC4-Cap  
Code: AC4-Cap-H



**Metal Clip**  
Code: AC4-Clip-M



**Plastic Endcap**  
(with/without hole) Code: AC5-Cap  
Code: AC5-Cap-H



**Plastic Clip**  
Code: AC4-Clip-P  
(Optional)



**Adjustable Clip**  
(0-222° rotation) Code: AC4-Clip-A  
(Optional)

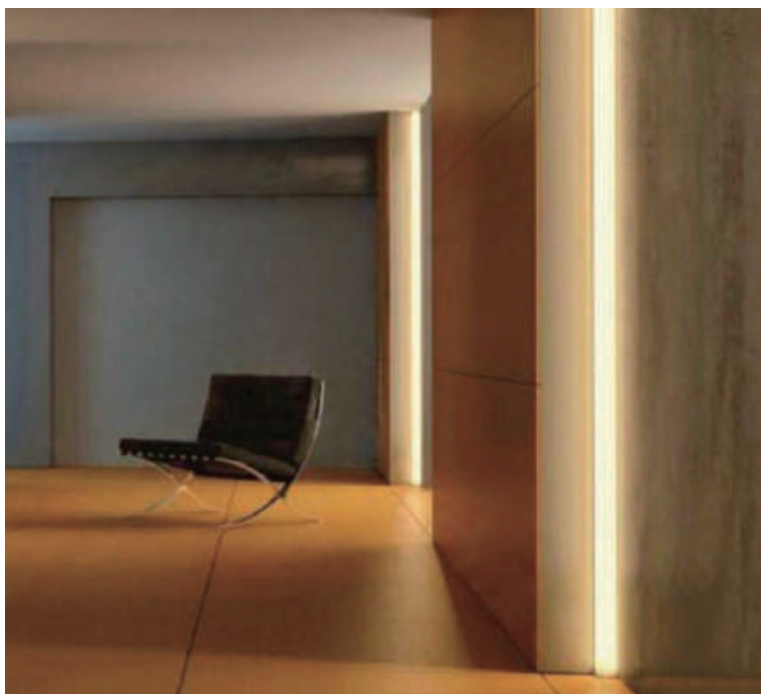
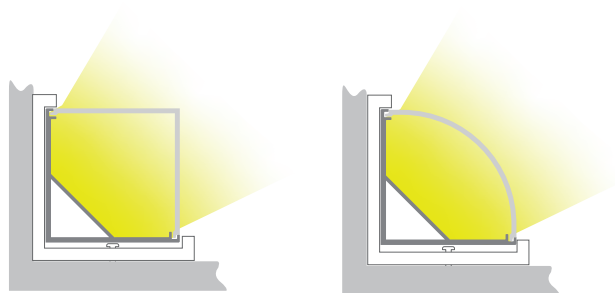

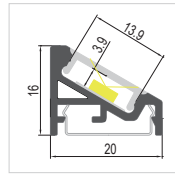

LW-AV2



## Aluminium Profile



AV2

### Specification:

Suitable for PCB 12mm

Max. LED power: 9.6w/m

Installation: Corner mounted

Material: Extruded Aluminium 6063

Finish: Silver anodised, Black or White \*

Diffuser: PMMA flexible diffuser, can be 25m continuous rolled

Length: 2000mm or 2500mm continuous \*\*

Size: Profile (W) 20mm, (H) 16mm

Driver installation: Remote driver required

\* Custom powder coated colour upon request. Surcharge apply.

\*\* Profile sold per metre. Can be cut to suit any length up to 6000mm.



#### PC Diffuser

Code: AV2-O (Opal, light trans. >50%)

## Installing accessories:



**Plastic Endcap**  
(with/without hole)  
Code: AV2-Cap-R  
Code: AV2-Cap-L



**Metal Clip**  
Code: US20-Clip-M



(Optional)

**Joiners 180°A**  
Code: J-180A



(Optional)

**Joiners 90°B**  
Code: J-90B



(Optional)

**Joiners 90°A**  
Code: J-90A



(Optional)

**Joiners 120°B**  
Code: J-120B



(Optional)

**Joiners 120°A**  
Code: J-120A

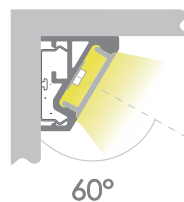
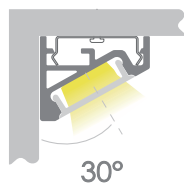

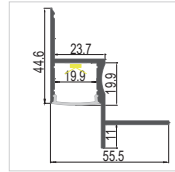

LW-AT7N



**Specification:**

Suitable for PCB	18mm
Max. LED power:	19.2w/m
Installation:	Wall/Ceiling recessed
Material:	Extruded Aluminium 6063
Finish:	Silver anodised, Black or White *
Diffuser:	PMMA flexible diffuser
Length:	2000mm or 2500mm continuous **
Size:	Profile (W) 55.5mm, (H) 46.6mm
Driver installation:	Remote driver required
* Custom powder coated colour upon request. Surcharge apply.	
** Profile sold per metre. Can be cut to suit any length up to 6000mm.	

**Aluminium Profile**



**AT7N**



**PMMA Diffuser**

- Code: AT7N-O (Opal, light trans. >52%)
- Code: AT7N-F (Frost, light trans. >81%)
- Code: AT7N-C (Clear, light trans. >95%)

**PC Diffuser**

- Code: AT7N-O (Opal, light trans. >50%)

## Installing accessories:



**Plastic Endcap** Code: AT7N-Cap  
(with/without hole) Code: AT7N-Cap-H

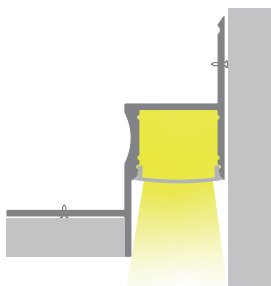

# Catalogue

- |    |                                    |          |  |
|----|------------------------------------|----------|--|
| 1  | SURFACE                            | 2        | RECESSED                               |
| 3  | CORNER                             | <b>4</b> | <b><i>SURFACE &amp; SUSPENSION</i></b> |
| 5  | WATERPROOF                         | 6        | STEP AND STAIR                         |
| 7  | ROUND                              | 8        | WALL                                   |
| 9  | DRIVER BUILT-IN PROFILE            | 10       | TRIMLESS-ARCHITECTURAL                 |
| 11 | SURFACE & SUSPENSION-ARCHITECTURAL | 12       | RECESSED-ARCHITECTURAL                 |
| 13 | PLASTER IN TRIMLESS                | 14       | BEND & CURVED                          |



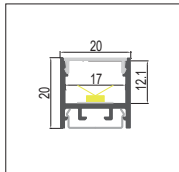

**LW-US20**  
Page 66

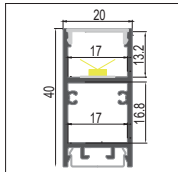

**LW-U20**  
Page 68

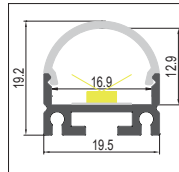

**LW-AT4**  
Page 70

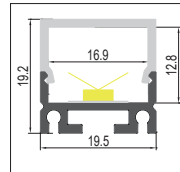

**LW-AT5**  
Page 70

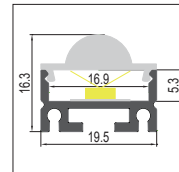

**LW-AT6**  
Page 70

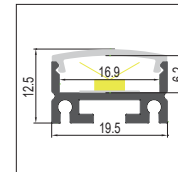

**LW-AT11**  
Page 72

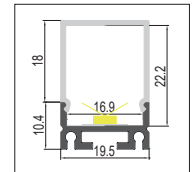

**LW-AT5H**  
Page 72

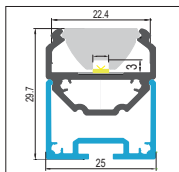

**LW-AT15-30**  
Page 74

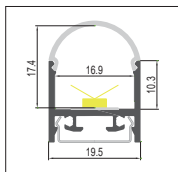

**LW-AT16-4**  
Page 76

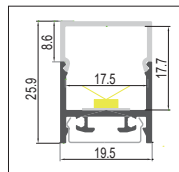

**LW-AT16-5**  
Page 76

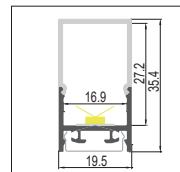

**LW-AT16-5H**  
Page 76

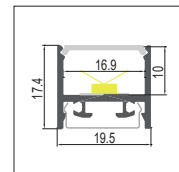

**LW-AT16-11**  
Page 78

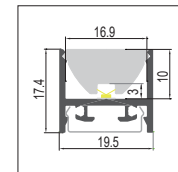

**LW-AT16-30-60**  
Page 78

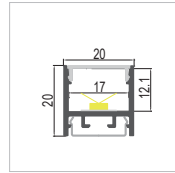

LW-US20



### Specification:

Suitable for PCB	15mm
Max. LED power:	19.2w/m
Installation:	Surface/Suspended
Material:	Extruded Aluminium 6063
Finish:	Silver anodised, Black or White *
Diffuser:	PMMA flexible diffuser, can be 25m continuous rolled
Length:	2000mm or 2500mm continuous **
Size:	Profile (W) 20mm, (H) 20mm
Driver installation:	Remote driver required

\* Custom powder coated colour upon request. Surcharge apply.

\*\* Profile sold per metre. Can be cut to suit any length up to 6000mm.

## Aluminium Profile



US20



#### PMMA Diffuser

Code: US20-O (Opal, light trans. >55%)



#### Black Diffuser

Code: US20-B (Black, light trans. > 22%)  
MOQ: 200M

## Installing accessories:



**Plastic Endcap**  
(with/without hole) Code: US20-Cap  
Code: US20-Cap-H



**Metal Clip**  
Code: US20-Clip-M



(Optional)

**Suspension Kits**  
Code: Sus.KitsA



(Optional)

**Joiners 90°A**  
Code: J-90A



(Optional)

**Joiners 90°B**  
Code: J-90B



(Optional)

**Joiners 120°A**  
Code: J-120A



(Optional)

**Joiners 120°B**  
Code: J-120B



(Optional)

**Joiners 180°A**  
Code: J-180A



(Optional)

**Aluminium diffuser**  
Code-US20-AD

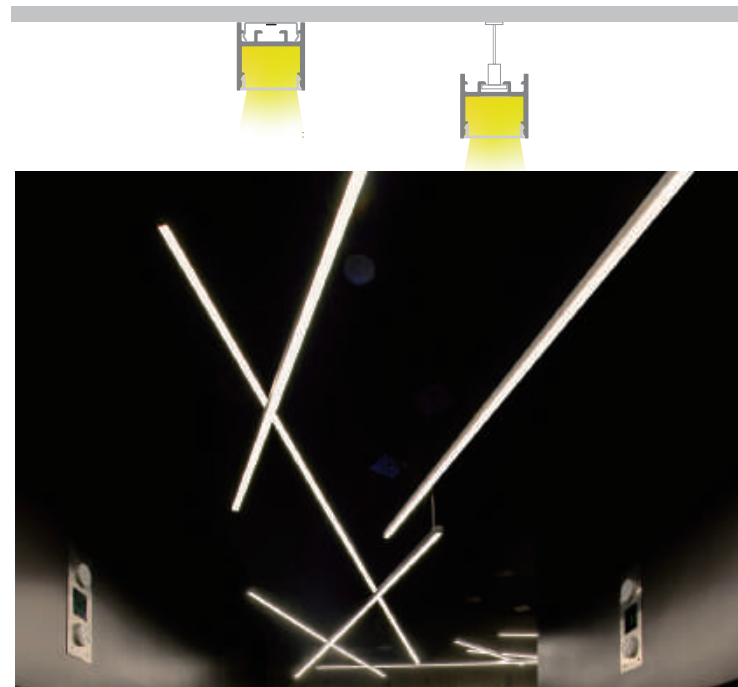

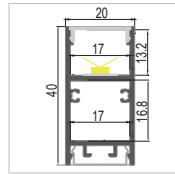

LW-U20



## Aluminium Profile



U20



### PMMA Diffuser

Code: U20-O (Opal, light trans. >55%)



### Black Diffuser

Code: US20-B (Black, light trans. > 22%)  
MOQ: 200M

## Specification:

Suitable for PCB 15mm

Max. LED power: 19.2w/m

Installation: Surface/Suspended

Material: Extruded Aluminium 6063

Finish: Silver anodised, Black or White \*

Diffuser: PMMA flexible diffuser, can be 25m continuous rolled

Length: 2000mm or 2500mm continuous \*\*

Size: Profile (W) 20mm, (H) 40mm

Driver installation: Remote driver required

\* Custom powder coated colour upon request. Surcharge apply.

\*\* Profile sold per metre. Can be cut to suit any length up to 6000mm.

## Installing accessories:

	<b>CNC Aluminum Cap</b> (without hole) Code: U20-Cap		<b>Metal Clip</b> Code: U20-Clip-M
 (Optional)	<b>Aluminium Endcap</b> (without hole) Code: U20-Cap	 (Optional)	<b>Suspension Kits</b> Code: Sus.KitsA
 (Optional)	<b>Joiners 90°A</b> Code: J-90A	 (Optional)	<b>Joiners 90°B</b> Code: J-90B
 (Optional)	<b>Joiners 120°A</b> Code: J-120A	 (Optional)	<b>Joiners 120°B</b> Code: J-120B
 (Optional)	<b>Joiners 180°A</b> Code: J-180A	 (Optional)	<b>Aluminium diffuser</b> Code: US20-AD

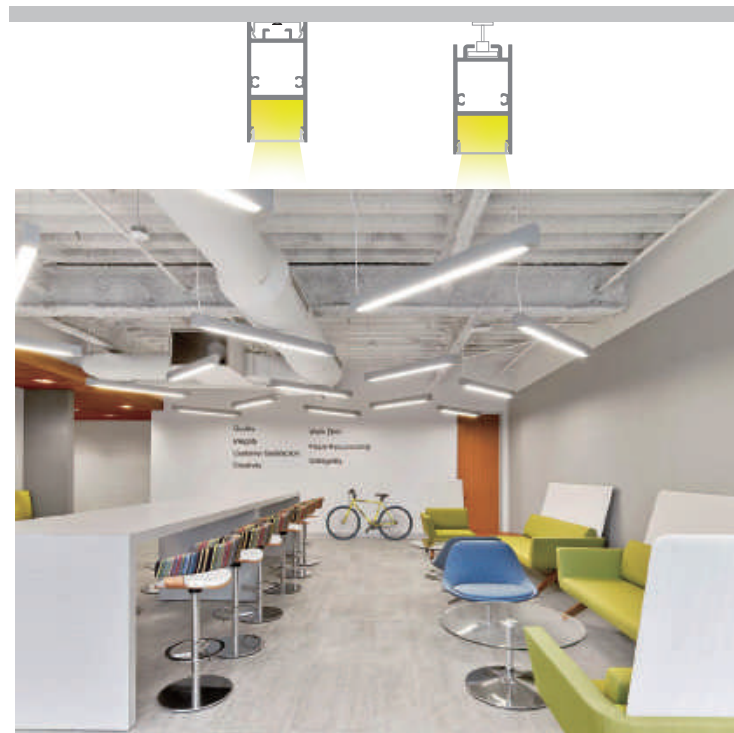

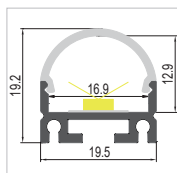

LW-AT4

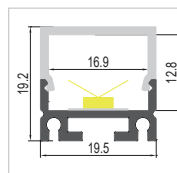

LW-AT5

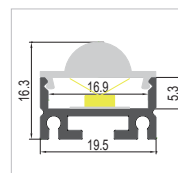

LW-AT6

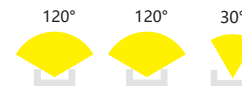

## Aluminium Profile



AT4



AT5



AT6



### PMMA Diffuser

Code: AT4-O (Opal, light trans. >52%)  
Code: AT4-F (Frost, light trans. >72%)



### PMMA Diffuser

Code: AT5-O (Opal, light trans. >52%)  
Code: AT5-F (Frost, light trans. >72%)

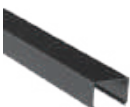

### Black Diffuser

Code: AT5-B (Black, light trans. >22%)  
MOQ: 200M



### PMMA Diffuser

Code: AT6-C (Clear, light trans. >95%)

## Specification:

Suitable for PCB 15mm

Max. LED power: 19.2w/m

Installation: Surface /Suspended

Material: Extruded Aluminium 6063

Finish: Silver anodised, Black or White \*

Diffuser: PMMA flexible diffuser

Length: 2000mm or 2500mm continuous \*\*

Size: Profile (W) 19.5mm, (H) 19.2mm

Driver installation: Remote driver required

\* Custom powder coated colour upon request. Surcharge apply.

\*\* Profile sold per metre. Can be cut to suit any length up to 6000mm.

## Installing accessories:

	<b>Plastic Endcap</b> (with/without hole)	Code: AT4-Cap Code: AT4-Cap-H		<b>Metal Clip</b> Code: AT11-Clip-M
	<b>Plastic Endcap</b> (with/without hole)	Code: AT5-Cap Code: AT5-Cap-H		<b>Suspension Kits</b> Code: Sus.KitsA (Optional)
	<b>Plastic Endcap</b> (with/without hole)	Code: AT6-Cap Code: AT6-Cap-H		<b>Joiners 180°A</b> Code: J-180A (Optional)
	<b>Adjustable Clip</b> (0-222° rotation)	Code: AT11-Clip-A (Optional)		<b>Joiners 90°B</b> Code: J-90B (Optional)
	<b>Joiners 120°A</b> Code: J-120A (Optional)			<b>Joiners 120°B</b> Code: J-120B (Optional)
	<b>Joiners 90°A</b> Code: J-90A (Optional)			

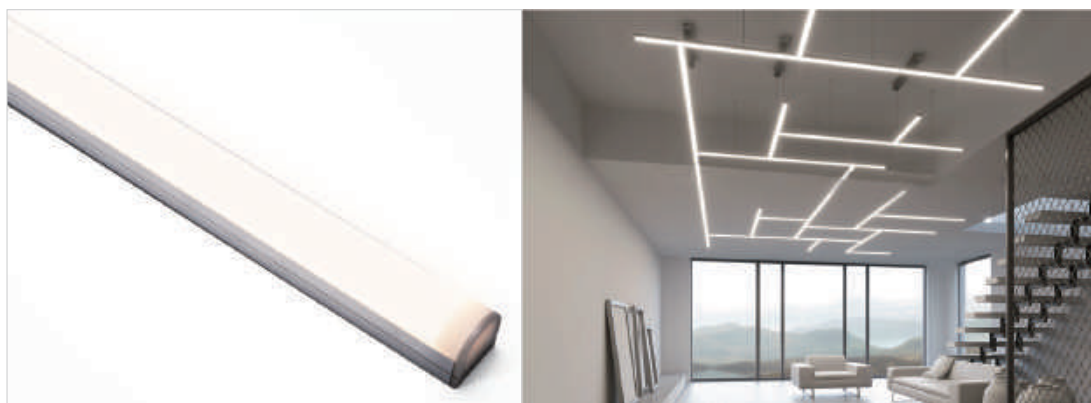
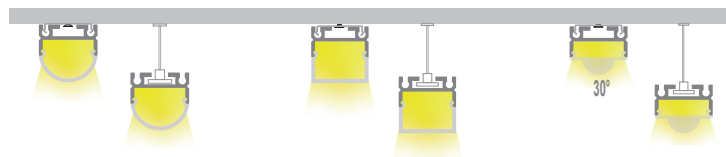

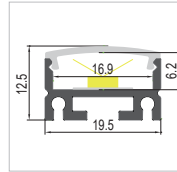

LW-AT11

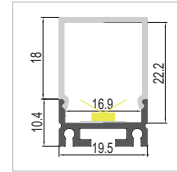

LW-AT5H

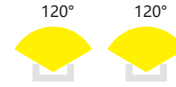

## Aluminium Profile



AT11



AT5H



### PMMA Diffuser

Code: AT11-O (Opal, light trans. >68%)  
Code: AT11-F (Frost, light trans. >83%)



### PMMA Diffuser

Code: AT5H-O (Opal, light trans. >52%)

## Specification:

Suitable for PCB 15mm

Max. LED power: 19.2w/m

Installation: Surface /Suspended

Material: Extruded Aluminium 6063

Finish: Silver anodised, Black or White \*

Diffuser: PMMA flexible diffuser, can be 25m continuous rolled (AT11)

Length: 2000mm or 2500mm continuous \*\*

Size: Profile (W) 19.5mm, (H) 12.5mm

Driver installation: Remote driver required

\* Custom powder coated colour upon request. Surcharge apply.

\*\* Profile sold per metre. Can be cut to suit any length up to 6000mm.



## Installing accessories:

	<b>Aluminium Endcap</b> (with/without hole) Code: AT11-Cap Code: AT11-Cap-H		<b>Metal Clip</b> Code: AT11-Clip-M
	<b>Aluminium Endcap</b> (with/without hole) Code: AT5H-Cap Code: AT5H-Cap-H		<b>Joiners 180°A</b> Code: J-180A (Optional)
	<b>Adjustable Clip</b> (0-222° rotation) Code: AT11-Clip-A (Optional)		<b>Joiners 90°A</b> Code: J-90A (Optional)
	<b>Joiners 90°B</b> Code: J-90B (Optional)		<b>Joiners 120°A</b> Code: J-120A (Optional)
	<b>Joiners 120°B</b> Code: J-120B (Optional)		<b>Suspension Kits</b> Code: Sus.KitsA (Optional)

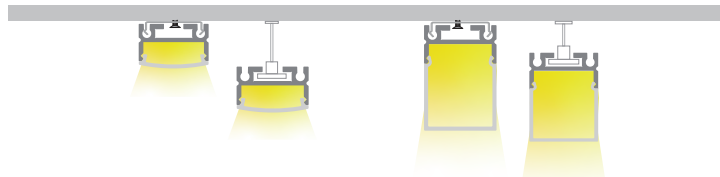

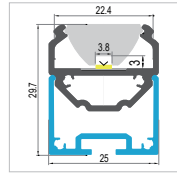
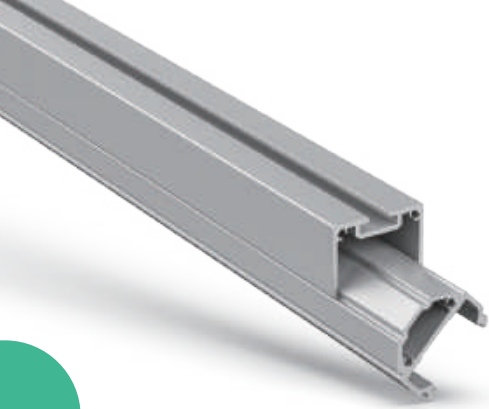

LW-AT15-60

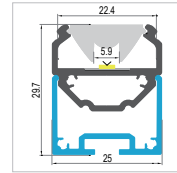

LW-AT15-30

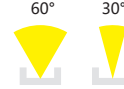

### Specification:

Suitable for PCB 10mm

Max. LED power: 28.8w/m

Installation: Surface /Suspended

Material: Extruded Aluminium 6063

Finish: Silver anodised, Black or White \*

Diffuser: PMMA flexible diffuser

Length: 2000mm or 2500mm continuous, lens in 350mm\*\*

Size: Profile (W) 25mm, (H) 29.7mm

Driver installation: Remote driver required

\* Custom powder coated colour upon request. Surcharge apply.

\*\* Profile sold per metre. Can be cut to suit any length up to 6000mm.

## Aluminium Profile



AT15-30



### PMMA Diffuser

Code: AT15-30-C (Clear, light trans. >95%)

## Installing accessories:



**Aluminium Endcap** Code: AT15-30-Cap  
(with/without hole) Code: AT15-30-Cap-H



(Optional)

**Suspension Kits**  
Code: Sus.KitsA



(Optional)

**Joiners 180°A**  
Code: J-180A



(Optional)

**Joiners 90°A**  
Code: J-90A



(Optional)

**Joiners 90°B**  
Code: J-90B



(Optional)

**Joiners 120°A**  
Code: J-120A



(Optional)

**Joiners 120°B**  
Code: J-120B

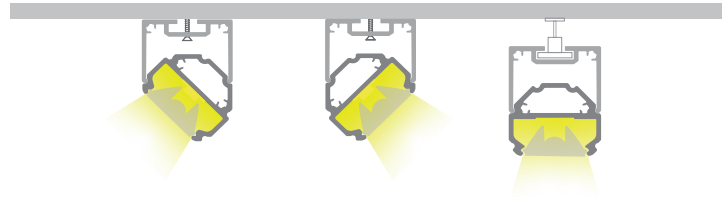

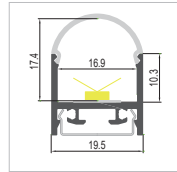

LW-AT16-4

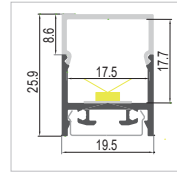

LW-AT16-5

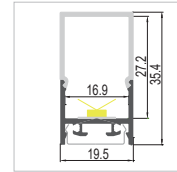

LW-AT16-5H



**Specification:**

Suitable for PCB 15mm

Max. LED power: 19.2w/m

Installation: Surface/Suspended

Material: Extruded Aluminium 6063

Finish: Silver anodised, Black or White \*

Diffuser: PMMA flexible diffuser

Length: 2000mm or 2500mm continuous \*\*

Size: Profile (W) 19.5mm, (H) 26.3mm

Driver installation: Remote driver required

\* Custom powder coated colour upon request. Surcharge apply.

\*\* Profile sold per metre. Can be cut to suit any length up to 6000mm.

**Aluminium Profile**

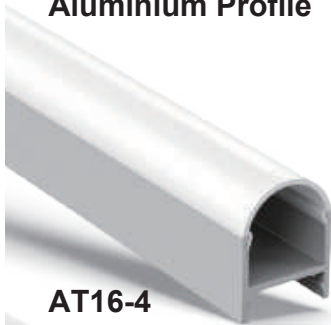

**AT16-4**



**AT16-5**



**AT16-5H**



**PMMA Diffuser**

Code: AT16-4-O (Opal, light trans. >52%)

Code: AT16-4-F (Frost, light trans. >72%)



**PMMA Diffuser**

Code: AT16-5-O (Opal, light trans. >52%)

Code: AT16-5-F (Frost, light trans. >72%)



**PMMA Diffuser**

Code: AT16-5H-O (Opal, light trans. >52%)

## Installing accessories:

	<b>Aluminium Endcap</b> (with/without hole) Code: AT16-4-Cap-R Code: AT16-4-Cap-L		<b>Metal Clip</b> Code: US20-Clip-M
	<b>Aluminium Endcap</b> (with/without hole) Code: AT16-5-Cap Code: AT16-5-Cap-H		<b>Suspension Kits</b> Code: Sus.KitsA
	<b>Aluminium Endcap</b> (with/without hole) Code: AT16-5H-Cap Code: AT16-5H-Cap-H		<b>Joiners 90°A</b> Code: J-90A
	<b>Joiners 90°B</b> Code: J-90B		<b>Joiners 120°A</b> Code: J-120A
	<b>Joiners 120°B</b> Code: J-120B		<b>Joiners 180°A</b> Code: J-180A

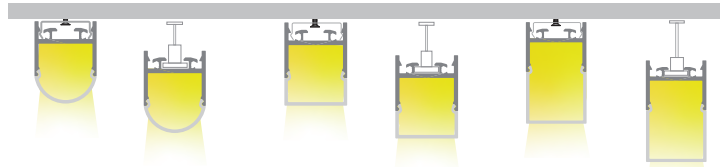

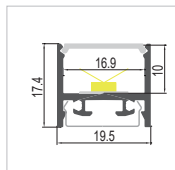

LW-AT16-11

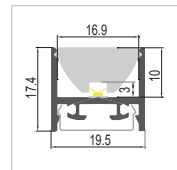

LW-AT16-30-60

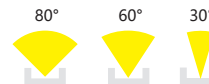

## Aluminium Profile



AT16-11



AT16-30-60

### Specification:

Suitable for PCB 15mm

Max. LED power: 19.2w/m

Installation: Surface/Suspended

Material: Extruded Aluminium 6063

Finish: Silver anodised, Black or White \*

Diffuser: PMMA flexible diffuser, can be 25m continuous rolled (AT16-11)

Length: 2000mm or 2500mm continuous, lens in 350mm (AT16-30-60) \*\*

Size: Profile (W) 19.5mm, (H) 17.4mm

Driver installation: Remote driver required

\* Custom powder coated colour upon request. Surcharge apply.

\*\* Profile sold per metre. Can be cut to suit any length up to 6000mm.



#### PMMA Diffuser

Code: AT16-11-O (Opal, light trans. >52%)

Code: AT16-11-F (Frost, light trans. >81%)



#### PMMA Diffuser

Code: AT16-30-60-C (Clear, light trans. >95%)



Clear lens 30°

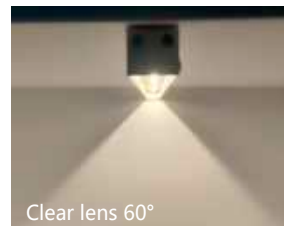

Clear lens 60°

## Installing accessories:

	<b>Aluminium Endcap</b> Code: AT16-11-Cap (with/without hole) Code: AT16-11-Cap-H		<b>Metal Clip</b> Code: US20-Clip-M
	<b>Aluminium Endcap</b> Code: AT16-30-60-Cap (with/without hole) Code: AT16-30-60-Cap-H		<b>Joiners 90°A</b> Code: J-90A (Optional)
	<b>Suspension Kits</b> Code: Sus.KitsA (Optional)		<b>Joiners 120°A</b> Code: J-120A (Optional)
	<b>Joiners 90°B</b> Code: J-90B (Optional)		<b>Joiners 180°A</b> Code: J-180A (Optional)
	<b>Joiners 120°B</b> Code: J-120B (Optional)		

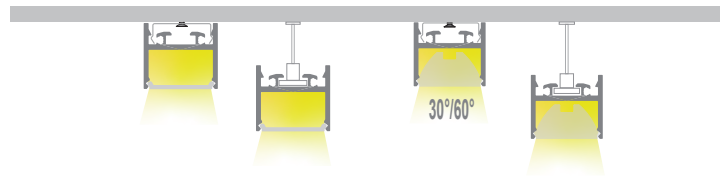

# Catalogue

- |    |                                    |    |                        |
|----|------------------------------------|----|------------------------|
| 1  | SURFACE                            | 2  | RECESSED               |
| 3  | CORNER                             | 4  | SURFACE & SUSPENSION   |
| 5  | <b>WATERPROOF</b>                  | 6  | STEP AND STAIR         |
| 7  | ROUND                              | 8  | WALL                   |
| 9  | DRIVER BUILT-IN PROFILE            | 10 | TRIMLESS-ARCHITECTURAL |
| 11 | SURFACE & SUSPENSION-ARCHITECTURAL | 12 | RECESSED-ARCHITECTURAL |
| 13 | PLASTER IN TRIMLESS                | 14 | BEND & CURVED          |



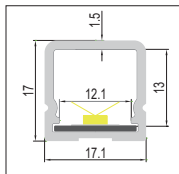

**LW-WP2**  
Page 82

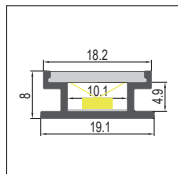

**LW-AA**  
Page 84

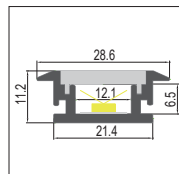

**LW-AB**  
Page 86

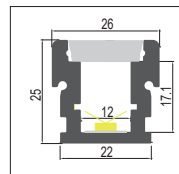

**LW-AF1**  
Page 88

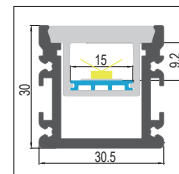

**LW-AF2**  
Page 90

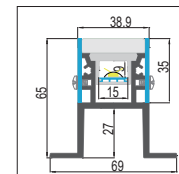

**LW-AF3**  
Page 92

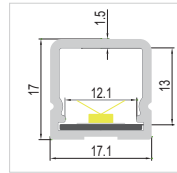

LW-WP2

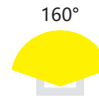

### Aluminium Profile



WP2

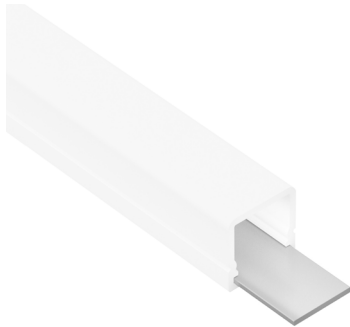

### PMMA Diffuser

Code: WP2-O (Opal, light trans. >52%)

### Specification:

Suitable for PCB 12mm

Max. LED power: 14.4w/m

Installation: Surface

Material: Extruded Aluminium 6063

Finish: Silver anodised, Black or White \*

Diffuser: PMMA flexible diffuser

Length: 2000mm or 2500mm continuous \*\*

Size: Profile (W) 17.1mm, (H) 17mm

Driver installation: Remote driver required

\* Custom powder coated colour upon request. Surcharge apply.

\*\* Profile sold per metre. Can be cut to suit any length up to 4000mm.

## Installing accessories:



**Plastic Endcap**  
(with/without hole) Code: WP2-Cap  
Code: WP2-Cap-H



(Optional)

**Metal Clip**  
Code: AS1-Clip-M



**Plastic Clip**  
Code: AS1-Clip-P

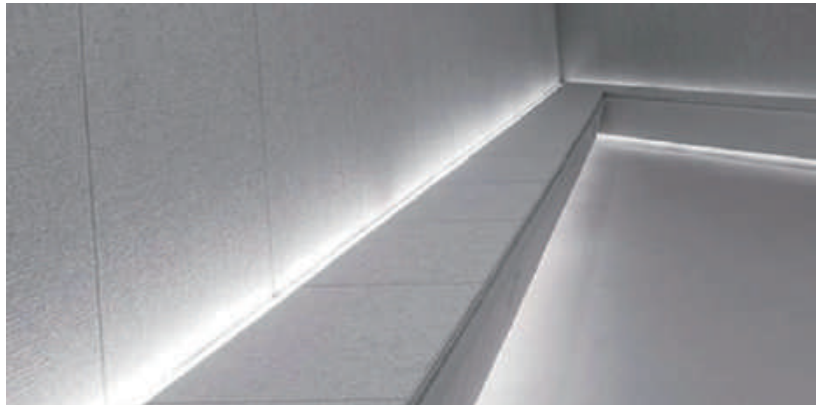
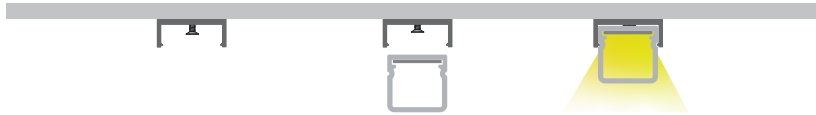

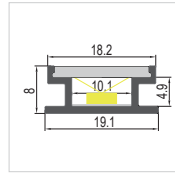

LW-AA

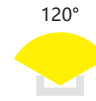

### Specification:

Suitable for PCB	10mm
Max. LED power:	14.4w/m
Installation:	Floor Recessed
Material:	Extruded Aluminium 6063
Finish:	Silver anodised *
Diffuser:	PC flexible diffuser
Length:	2000mm or 2500mm continuous **
Size:	Profile (W) 19.1mm, (H) 8mm
Driver installation:	Remote driver required
* Custom powder coated colour upon request. Surcharge apply.	
** Profile sold per metre. Can be cut to suit any length up to 4000mm.	

## Aluminium Profile

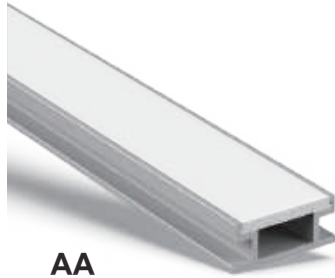

AA



**PC Diffuser**  
Code: AA-O (Opal, light trans. >50%)

## Installing accessories:



**Plastic Endcap** Code: AA-Cap  
(with/without hole) Code: AA-Cap-H



(Optional)

**Metal Clip**  
Code: AA-Clip-M

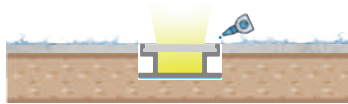

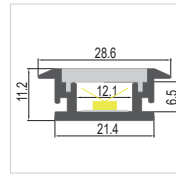

LW-AB



## Aluminium Profile

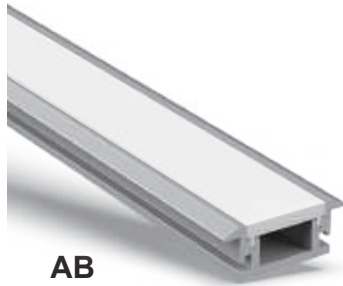

AB

### Specification:

Suitable for PCB	12mm
Max. LED power:	14.4w/m
Installation:	Floor Recessed
Material:	Extruded Aluminium 6063
Finish:	Silver anodised *
Diffuser:	PC flexible diffuser
Length:	2000mm or 2500mm continuous **
Size:	Profile (W) 28.6mm, (H) 11.2mm
Driver installation:	Remote driver required
* Custom powder coated colour upon request. Surcharge apply.	
** Profile sold per metre. Can be cut to suit any length up to 4000mm.	



**PC Diffuser**  
Code: AB-O (Opal, light trans. >50%)

## Installing accessories:



**Plastic Endcap** Code: AB-Cap  
(with/without hole) Code: AB-Cap-H



(Optional)

**Metal Clip**  
Code: AB-Clip-M

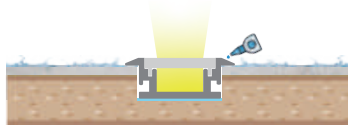

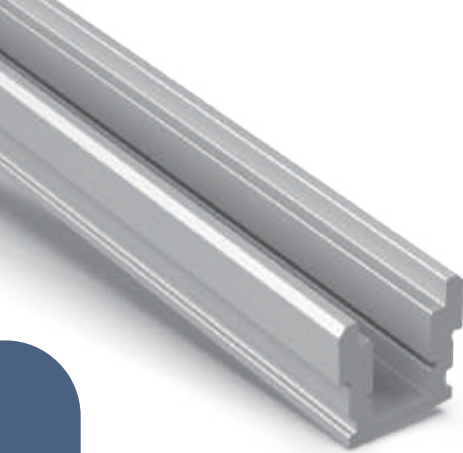

**Aluminium Profile**



**AF1**

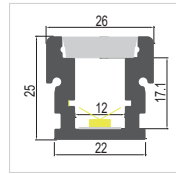

LW-AF1



**Specification:**

Suitable for PCB 12mm	
Max. LED power:	19.2w/m
Installation:	Inground Recessed
Material:	Extruded Aluminium 6063
Finish:	Silver anodised *
Diffuser:	PC flexible diffuser
Length:	2000mm or 2500mm continuous **
Size:	Profile (W) 26mm, (H) 25mm
Driver installation: Remote driver required	
* Custom powder coated colour upon request. Surcharge apply.	
** Profile sold per metre. Can be cut to suit any length up to 6000mm.	



**PC Diffuser**  
Code: AF1-O (Opal, light trans. >45%)



## Installing accessories:



**Plastic Endcap** Code: AF1-Cap  
(with/without hole) Code: AF1-Cap-H



(Optional)

**Metal Clip**  
Code: AF1-Clip-M

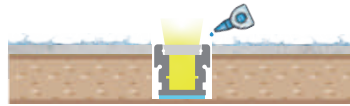

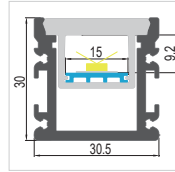

LW-AF2



80°

### Specification:

Suitable for PCB 15mm	
Max. LED power:	19.2w/m
Installation:	Inground Recessed
Material:	Extruded Aluminium 6063
Finish:	Silver anodised *
Diffuser:	PC flexible diffuser
Length:	2000mm or 2500mm continuous **
Size:	Profile (W) 30.5mm, (H) 30mm
Driver installation:	Remote driver required

\* Custom powder coated colour upon request. Surcharge apply.

\*\* Profile sold per metre. Can be cut to suit any length up to 2500mm.

## Aluminium Profile

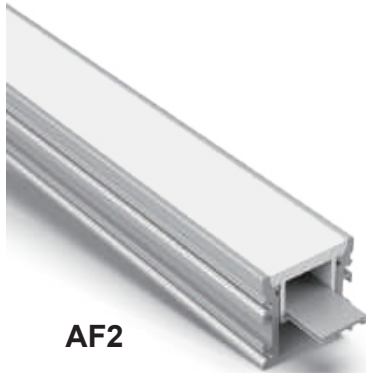

AF2



### PC Diffuser

Code: AF2-O (Opal, light trans. >45%)

## Installing accessories:



**Aluminium Endcap** Code: AF2-Cap  
(with/without hole) Code: AF2-Cap-H



**Soft Endcap**  
Code: AF2-Cap-H



(Optional)

**Waterproof Cable Grommet**  
Code: AF2-WP



(Optional)

**Metal Clip**  
Code: AF2-Clip-M



(Optional)

**IP68 Waterproof Connector**  
Code: AF2-WC



(Optional)

**IP68 Waterproof Box**  
Code: AF2-WB

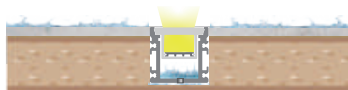

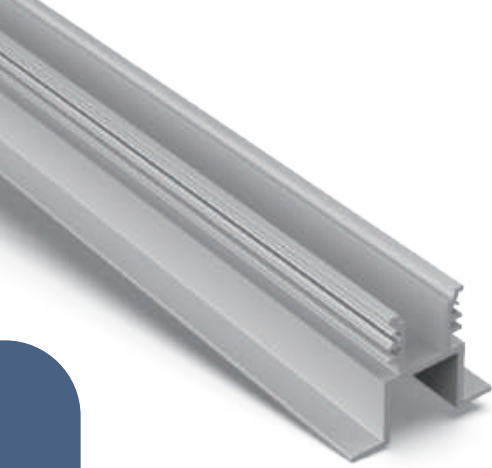

Aluminium Profile

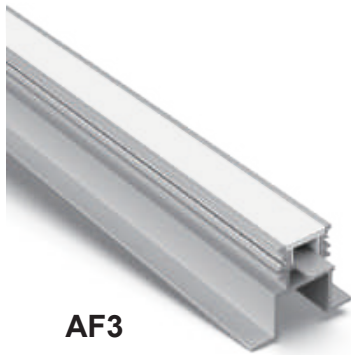

AF3

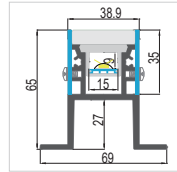

LW-AF3



**Specification:**

Suitable for PCB 15 mm	
Max. LED power:	19.2w/m
Installation:	Inground Recessed
Material:	Extruded Aluminium 6063 + Stainless steel 304
Finish:	Silver anodised *
Diffuser:	PC flexible diffuser
Length:	2000mm or 2500mm continuous **
Size:	Profile (W) 69mm, (H) 65mm
Driver installation:	Remote driver required
* Custom powder coated colour upon request. Surcharge apply.	
** Profile sold per metre. Can be cut to suit any length up to 2500mm.	



**PC Diffuser**  
Code: AF3-O (Opal, light trans. >45%)

## Installing accessories:



Aluminium Endcap Code: AF3-Cap  
(without hole)



Soft Endcap  
Code: AF3-Cap-H



Stainless steel side bar  
Code: AF3-SB



Glass Diffuser  
Code: AF3-Glass



(Optional)

Waterproof Cable Grommet  
Code: AF3-WP



(Optional)

IP68 Waterproof Box  
Code: AF3-WB



(Optional)

IP68 Waterproof Connector  
Code: AF3-WC

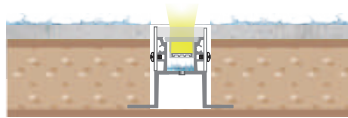

# Catalogue

- |    |                                    |          |                              |
|----|------------------------------------|----------|------------------------------|
| 1  | SURFACE                            | 2        | RECESSED                     |
| 3  | CORNER                             | 4        | SURFACE & SUSPENSION         |
| 5  | WATERPROOF                         | <b>6</b> | <b><i>STEP AND STAIR</i></b> |
| 7  | ROUND                              | 8        | WALL                         |
| 9  | DRIVER BUILT-IN PROFILE            | 10       | TRIMLESS-ARCHITECTURAL       |
| 11 | SURFACE & SUSPENSION-ARCHITECTURAL | 12       | RECESSED-ARCHITECTURAL       |
| 13 | PLASTER IN TRIMLESS                | 14       | BEND & CURVED                |

## STEP AND STAIR

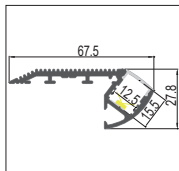

LW-ST1  
Page 96

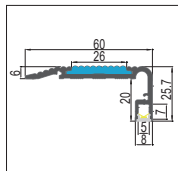

LW-ST2  
Page 98

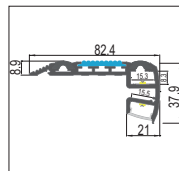

LW-STR3  
Page 100

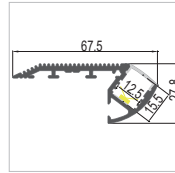

LW-ST1



## Aluminium Profile

### Specification:

Suitable for PCB 12mm	
Max. LED power:	19.2w/m
Installation:	Step and Stair
Material:	Extruded Aluminium 6063
Finish:	Silver anodised, Black anodised *
Diffuser:	PMMA flexible diffuser, can be 25m continuous rolled
Length:	2000mm or 2500mm continuous **
Size:	Profile (W) 67.5mm, (H) 27.8mm
Driver installation: Remote driver required	
* Custom powder coated colour upon request. Surcharge apply.	
** Profile sold per metre. Can be cut to suit any length up to 6000mm.	

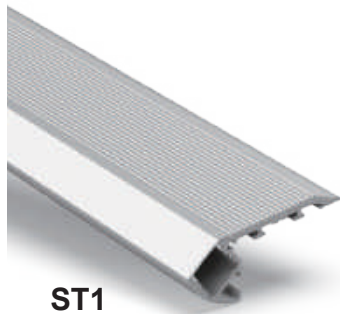

ST1

#### PMMA Diffuser

- Code: ST1-O (Opal, light trans. >52%)
- Code: ST1-M (Milky, light trans. >65%)
- Code: ST1-F (Frost, light trans. >81%)
- Code: ST1-C (Clear, light trans. >95%)

#### PC Diffuser

- Code: ST1-O (Opal, light trans. >50%)
- Code: ST1-F (Frost, light trans. >79%)
- Code: ST1-C (Clear, light trans. >93%)

#### Black Diffuser

- Code: AS1-B (Black, light trans. > 22%)
- MOQ: 200M





## Installing accessories:



Plastic Endcap Code: ST1-Cap-H  
(with/without hole) Code: ST1-Cap-L

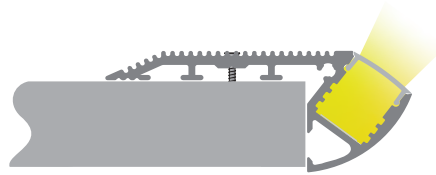

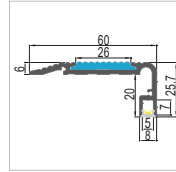
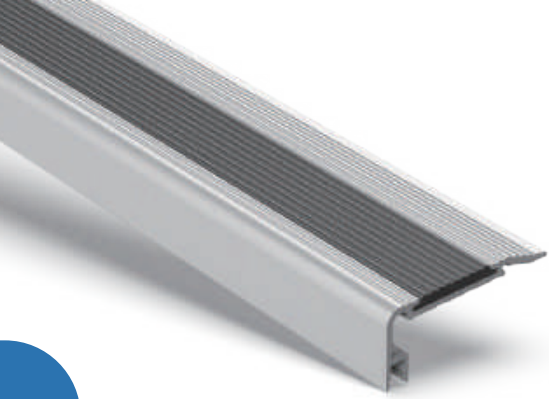

LW-ST2

40°



### Specification:

Suitable for PCB	5mm
Max. LED power:	9.6w/m
Installation:	Step and Stair
Material:	Extruded Aluminium 6063
Finish:	Silver anodised, Black anodised *
Diffuser:	PMMA flexible diffuser, can be 25m continuous rolled
Length:	2000mm or 2500mm continuous **
Size:	Profile (W) 60mm, (H) 27.5mm
Driver installation:	Remote driver required
* Custom powder coated colour upon request. Surcharge apply.	
** Profile sold per metre. Can be cut to suit any length up to 6000mm.	

## Aluminium Profile



ST2



### PC Diffuser

Code: ST2-O (Opal, light trans. >50%)  
Code: ST2-C (Clear, light trans. >93%)

## Installing accessories:



Plastic Endcap  
(without hole)

Code: ST2-Cap-R  
Code: ST2-Cap-L



Anti-slip rubber  
Code: ST2-ASRUB

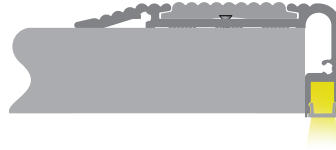

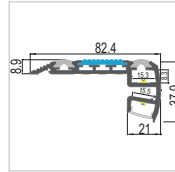
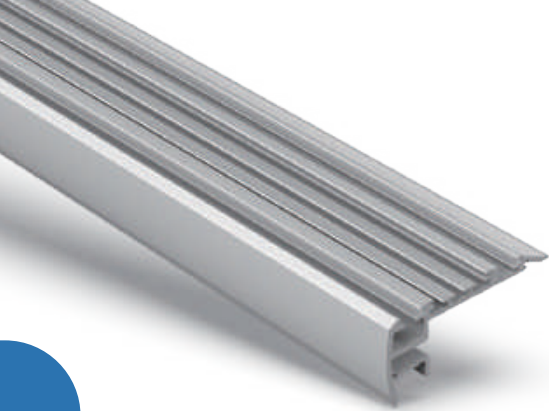

LW-STR3



## Aluminium Profile

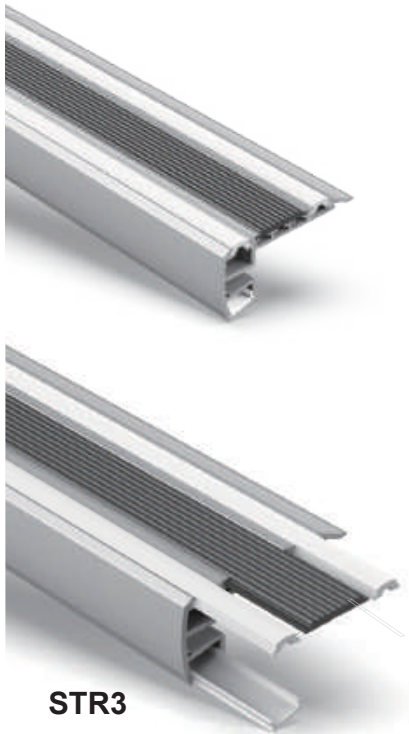

STR3

### Specification:

Suitable for PCB 15mm

Max. LED power: 19.2w/m

Installation: Step and Stair

Material: Extruded Aluminium 6063

Finish: Silver anodised, Black anodised \*

Diffuser: PMMA flexible diffuser, can be 25m continuous rolled

Length: 2000mm or 2500mm continuous \*\*

Size: Profile (W) 82.4mm, (H) 37.9mm

Driver installation: Remote driver required

\* Custom powder coated colour upon request. Surcharge apply.

\*\* Profile sold per metre. Can be cut to suit any length up to 6000mm.

#### PMMA Diffuser

Code: STR3-O (Opal, light trans. >52%)

Code: STR3-M (Milky, light trans. >65%)

Code: STR3-F (Frost, light trans. >81%)

Code: STR3-C (Clear, light trans. >95%)

#### PC Diffuser

Code: STR3-O (Opal, light trans. >50%)

Code: STR3-F (Frost, light trans. >79%)

Code: STR3-C (Clear, light trans. >93%)



## Installing accessories:



Plastic Endcap  
(without hole) Code: STR3-Cap-R  
Code: STR3-Cap-L



Anti-slip rubber (25mm)  
Code: STR3-ASRUB-B



Anti-slip rubber  
Code: STR3-ASRUB

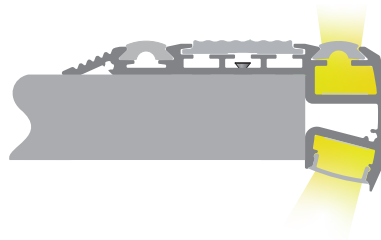

# Catalogue

- |    |                                    |    |                        |
|----|------------------------------------|----|------------------------|
| 1  | SURFACE                            | 2  | RECESSED               |
| 3  | CORNER                             | 4  | SURFACE & SUSPENSION   |
| 5  | WATERPROOF                         | 6  | STEP AND STAIR         |
| 7  | <b>ROUND</b>                       | 8  | WALL                   |
| 9  | DRIVER BUILT-IN PROFILE            | 10 | TRIMLESS-ARCHITECTURAL |
| 11 | SURFACE & SUSPENSION-ARCHITECTURAL | 12 | RECESSED-ARCHITECTURAL |
| 13 | PLASTER IN TRIMLESS                | 14 | BEND & CURVED          |

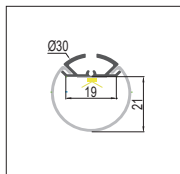
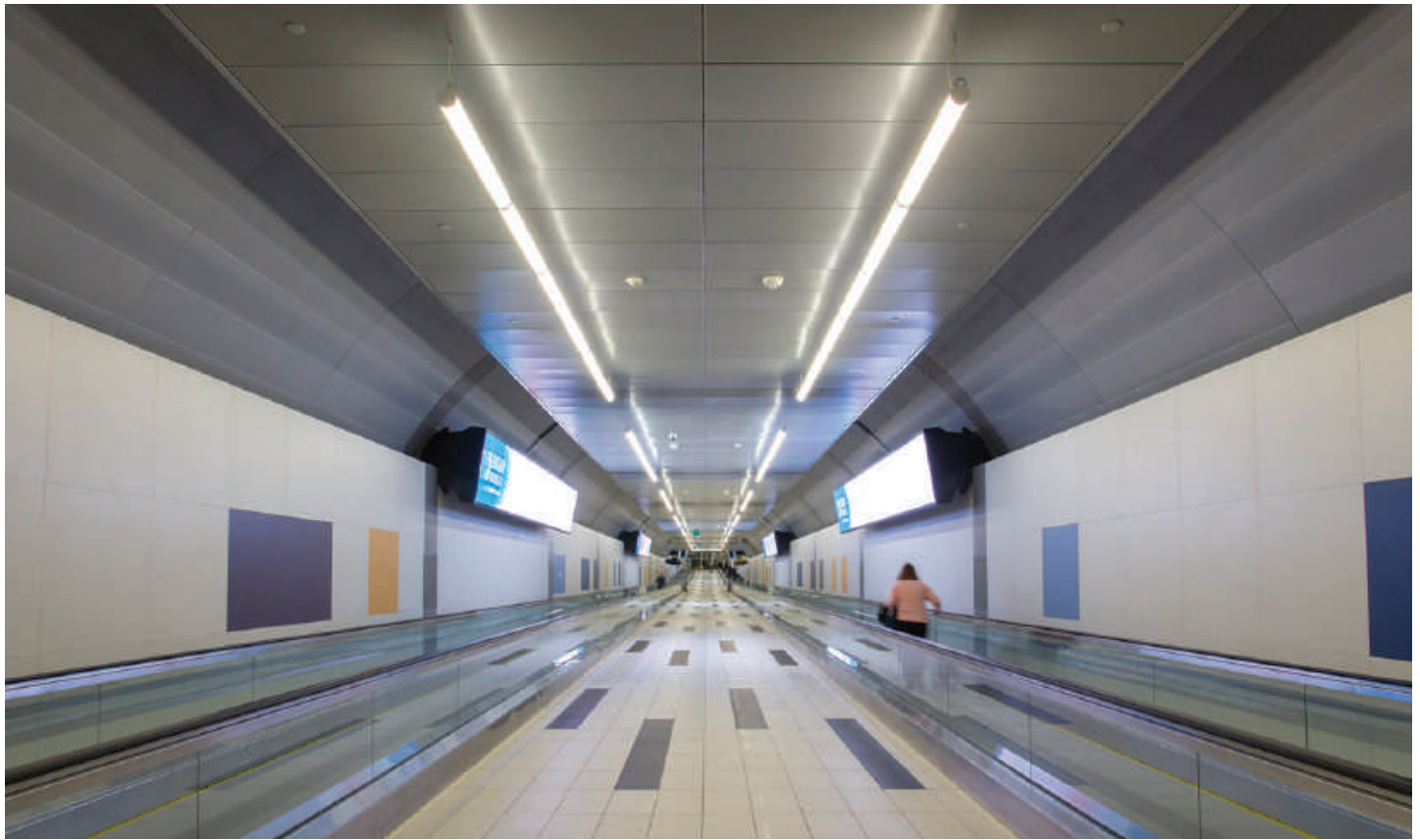

LW-R30  
Page 104

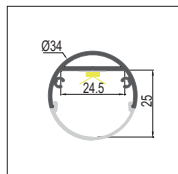

LW-R34  
Page 106

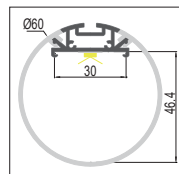

LW-R60  
Page 108

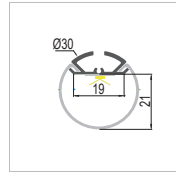

LW-R30

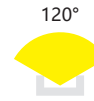

### Specification:

Suitable for PCB 18mm

Max. LED power: 28.8w/m

Installation: Surface /Suspended

Material: Extruded Aluminium 6063

Finish: Silver anodised, Black or White \*

Diffuser: PC flexible diffuser

Length: 2000mm or 2500mm continuous \*\*

Size: Profile (W) 30mm, (H) 30mm

Driver installation: Remote driver required

\* Custom powder coated colour upon request. Surcharge apply.

\*\* Profile sold per metre. Can be cut to suit any length up to 4000mm.

## Aluminium Profile



R30



### PC Diffuser

Code: R30-O (Opal, light trans. >50%)



## Installing accessories:



**Plastic Endcap**  
(with/without hole) Code: R30-Cap  
Code: R30-Cap-H



**Suspension Kits**  
Code: Sus.KitsA

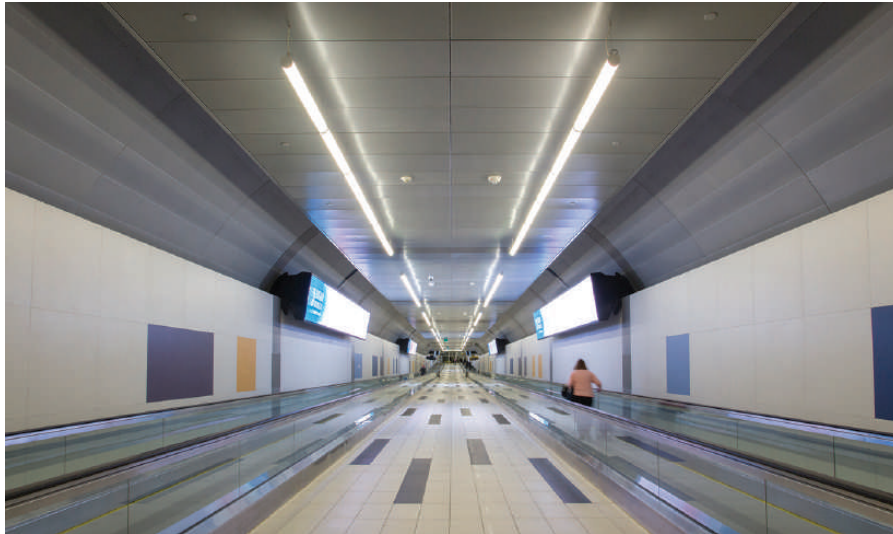
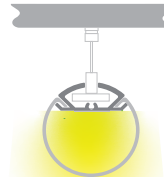

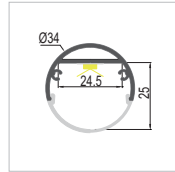
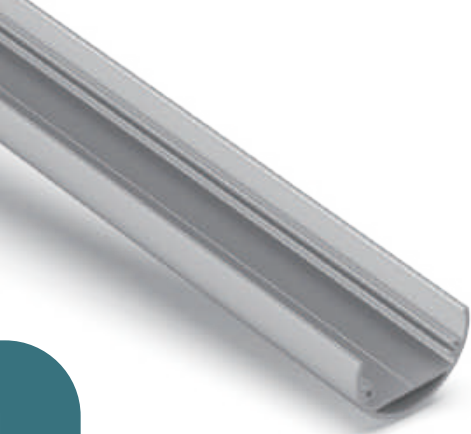

LW-R34



## Aluminium Profile



R34

Extrusive in Australia

### Specification:

Suitable for PCB 24mm

Max. LED power: 28.8w/m

Installation: Wardrobe hanging /Suspended

Material: Extruded Aluminium 6063

Finish: Silver anodised, Black or White \*

Diffuser: PC flexible diffuser

Length: 2000mm or 2500mm continuous \*\*

Size: Profile (W) 34mm, (H) 34mm

Driver installation: Remote driver required

\* Custom powder coated colour upon request. Surcharge apply.

\*\* Profile sold per metre. Can be cut to suit any length up to 5000mm.



#### PC Diffuser

Code: R34-O (Opal, light trans. >50%)

## Installing accessories:



**Aluminium Endcap** Code: R34-Cap  
(with/without hole) Code: R34-Cap-H



**Wall Bracket**  
Code: R34-A



(Optional)

**Supporter**  
Code: R34-B

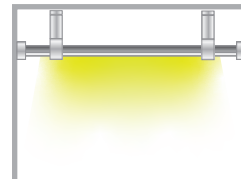

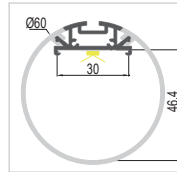

LW-R60



## Aluminium Profile



R60



**PC Diffuser**  
Code: R60-O (Opal, light trans. >50%)

### Specification:

Suitable for PCB 30mm

Max. LED power: 28.8w/m

Installation: Suspended

Material: Extruded Aluminium 6063

Finish: Silver anodised, Black or White \*

Diffuser: PC flexible diffuser

Length: 2000mm or 2500mm continuous \*\*

Size: Profile (W) 60mm, (H) 60mm

Driver installation: Remote driver required

\* Custom powder coated colour upon request. Surcharge apply.

\*\* Profile sold per metre. Can be cut to suit any length up to 6000mm.

## Installing accessories:



Plastic Endcap Code: R60-Cap  
(without hole)



Suspension Kits  
Code: Sus.KitsA



(Optional)

Aluminium Endcap Code: R60-Cap  
(without hole)

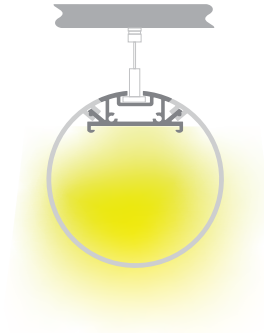

# Catalogue

- |    |                                    |          |                        |
|----|------------------------------------|----------|------------------------|
| 1  | SURFACE                            | 2        | RECESSED               |
| 3  | CORNER                             | 4        | SURFACE & SUSPENSION   |
| 5  | WATERPROOF                         | 6        | STEP AND STAIR         |
| 7  | ROUND                              | <b>8</b> | <b>WALL</b>            |
| 9  | DRIVER BUILT-IN PROFILE            | 10       | TRIMLESS-ARCHITECTURAL |
| 11 | SURFACE & SUSPENSION-ARCHITECTURAL | 12       | RECESSED-ARCHITECTURAL |
| 13 | PLASTER IN TRIMLESS                | 14       | BEND & CURVED          |

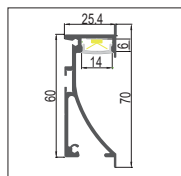

LW-AW1  
Page 112

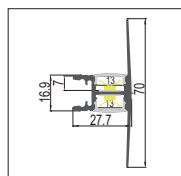

LW-AW2  
Page 114

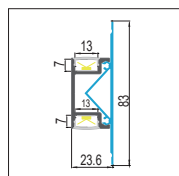

LW-AW4-1  
Page 116

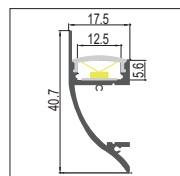

LW-AW8  
Page 118

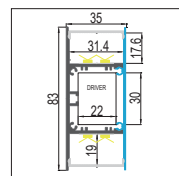

LW-AW5-1  
Page 120

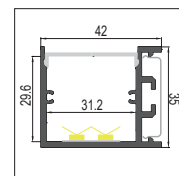

LW-AW35  
Page 122

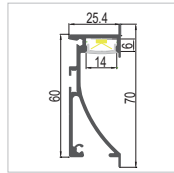
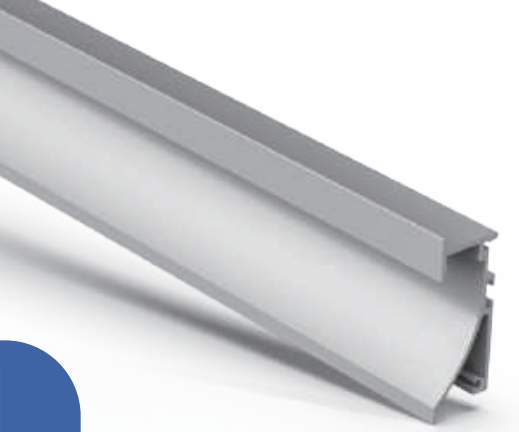

LW-AW1



## Aluminium Profile



AW1

### Specification:

Suitable for PCB 12mm

Max. LED power: 19.2w/m

Installation: Wall flush

Material: Extruded Aluminium 6063

Finish: Silver anodised, Black or White \*

Diffuser: PMMA flexible diffuser, can be 25m continuous rolled

Length: 2000mm or 2500mm continuous \*\*

Size: Profile (W) 25.4mm, (H) 60mm

Driver installation: Remote driver required

\* Custom powder coated colour upon request. Surcharge apply.

\*\* Profile sold per metre. Can be cut to suit any length up to 6000mm.

#### PMMA Diffuser

Code: AW1-O (Opal, light trans. >52%)

Code: AW1-M (Milky, light trans. >65%)

Code: AW1-F (Frost, light trans. >81%)

Code: AW1-C (Clear, light trans. >95%)

#### PC Diffuser

Code: AW1-O (Opal, light trans. >52%)





## Installing accessories:



**Aluminium Endcap** Code: AW1-Cap-L  
(with/without hole) Code: AW1-Cap-R



(Optional)

**Metal Clip**  
Code: AW1-Clip-M



**Spring Clip**  
Code: SC-AW1

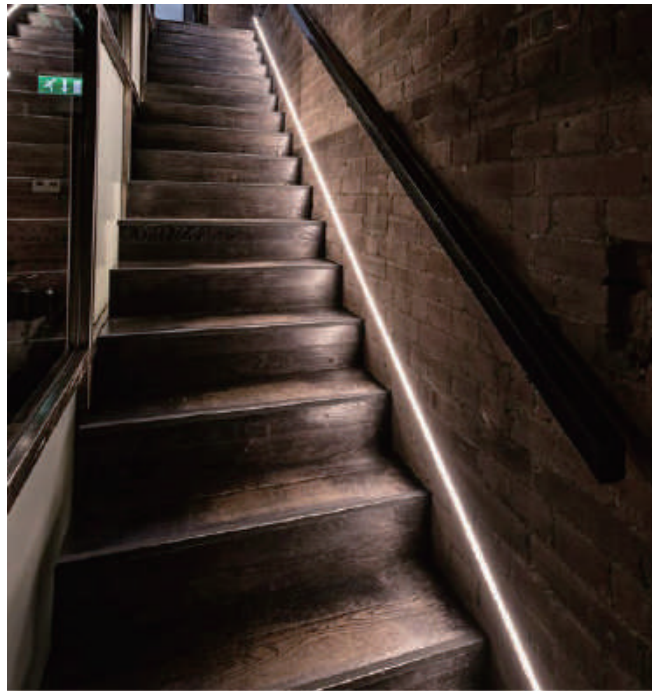
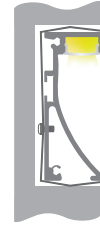
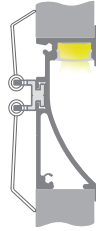

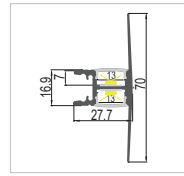
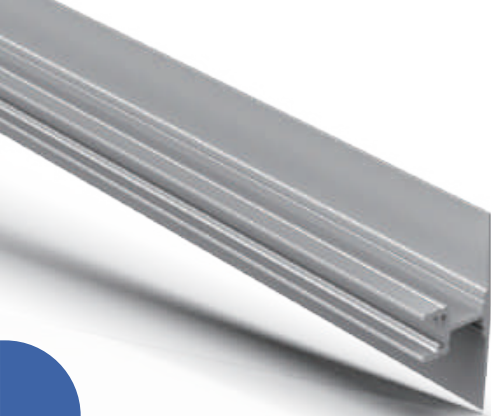

LW-AW2



## Aluminium Profile



AW2

### Specification:

Suitable for PCB 12mm

Max. LED power: 14.4w/m

Installation: Wall Surface mounted

Material: Extruded Aluminium 6063

Finish: Silver anodised, Black or White \*

Diffuser: PMMA flexible diffuser, can be 25m continuous rolled

Length: 2000mm or 2500mm continuous \*\*

Size: Profile (W) 27.7mm, (H) 70mm

Driver installation: Remote driver required

\* Custom powder coated colour upon request. Surcharge apply.

\*\* Profile sold per metre. Can be cut to suit any length up to 6000mm.

#### PMMA Diffuser

Code: AW2-O (Opal, light trans. >52%)

Code: AW2-M (Milky, light trans. >65%)

Code: AW2-F (Frost, light trans. >81%)

Code: AW2-C (Clear, light trans. >95%)

#### PC Diffuser

Code: AW2-O (Opal, light trans. >52%)



## Installing accessories:



**Aluminium Endcap** Code: AW2-Cap  
(without hole)



**Metal Clip**  
Code: AW2-Clip-M

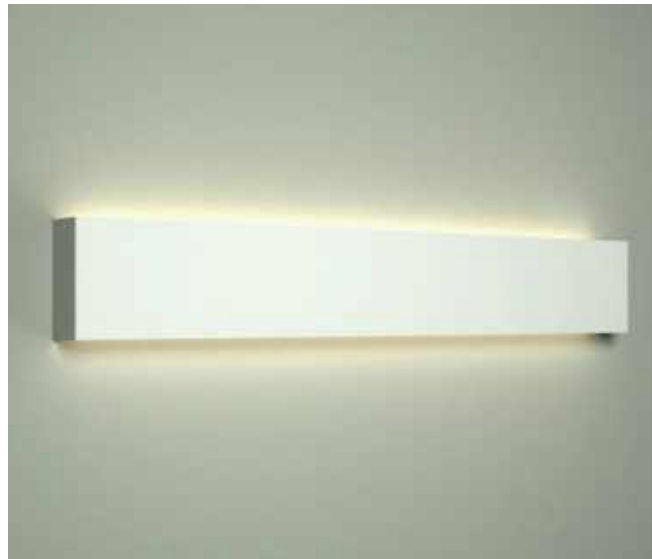
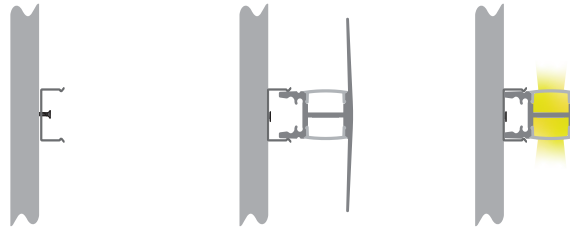

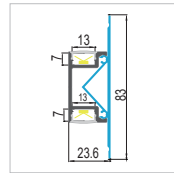

LW-AW4-1



## Aluminium Profile



AW4-1

### Specification:

Suitable for PCB 12mm	
Max. LED power:	14.4w/m
Installation:	Wall Surface mounted
Material:	Extruded Aluminium 6063
Finish:	Silver anodised, Black or White *
Diffuser:	PMMA flexible diffuser, can be 25m continuous rolled
Length:	2000mm or 2500mm continuous **
Size:	Profile (W) 23.6mm, (H) 83mm
Driver installation:	Remote driver required
* Custom powder coated colour upon request. Surcharge apply.	
** Profile sold per metre. Can be cut to suit any length up to 4000mm.	



#### PMMA Diffuser

- Code: AW4-1-O (Opal, light trans. >52%)
- Code: AW4-1-M (Milky, light trans. >65%)
- Code: AW4-1-F (Frost, light trans. >81%)
- Code: AW4-1-C (Clear, light trans. >95%)

#### PC Diffuser

- Code: AW4-1-O (Opal, light trans. >52%)

## Installing accessories:



Aluminium Endcap Code: AW4-1-Cap  
(without hole)

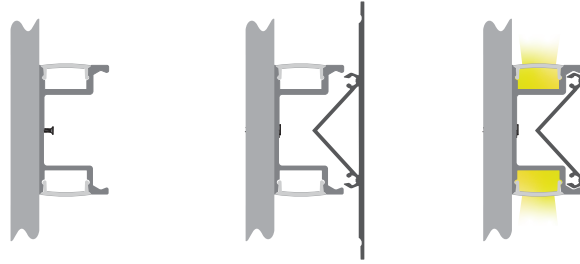

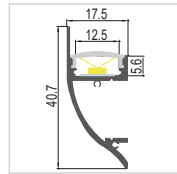
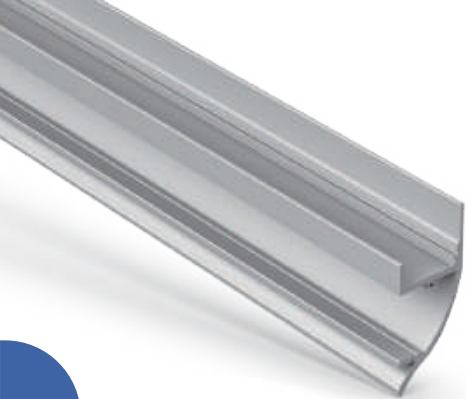

LW-AW8



## Aluminium Profile



AW8

### Specification:

Suitable for PCB 12mm

Max. LED power: 19.2w/m

Installation: Wall Surface mounted

Material: Extruded Aluminium 6063

Finish: Silver anodised, Black or White \*

Diffuser: PMMA flexible diffuser, can be 25m continuous rolled

Length: 2000mm or 2500mm continuous \*\*

Size: Profile (W) 17.5mm, (H) 40.7mm

Driver installation: Remote driver required

\* Custom powder coated colour upon request. Surcharge apply.

\*\* Profile sold per metre. Can be cut to suit any length up to 4000mm.



#### PC Diffuser

Code: AW8-O (Opal, light trans. >52%)

## Installing accessories:



**Plastic Endcap** Code: AW8-Cap-R  
(without hole) Code: AW8-Cap-L



**Metal Clip**  
Code: AW8-Clip-M

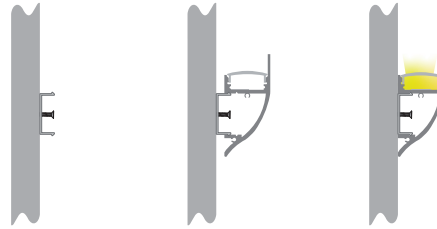

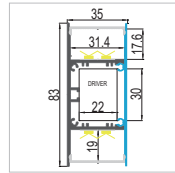
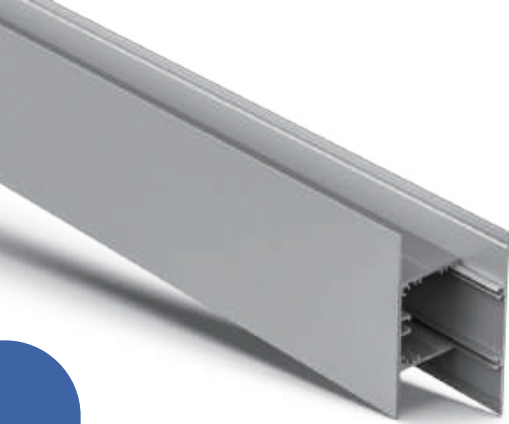

LW-AW5-1



## Aluminium Profile



AW5-1

### Specification:

Suitable for PCB 30mm	
Max. LED power:	19.2w/m
Installation:	Wall Surface mounted
Material:	Extruded Aluminium 6063
Finish:	Silver anodised, Black or White *
Diffuser:	PMMA flexible diffuser, can be 25m continuous rolled
Length:	2000mm or 2500mm continuous **
Size:	Profile (W) 35mm, (H) 83mm
Driver installation:	Remote or integral driver required
* Custom powder coated colour upon request. Surcharge apply.	
** Profile sold per metre. Can be cut to suit any length up to 4000mm.	



#### PMMA Diffuser

- Code: AW5-1-O (Opal, light trans. >63%)
- Code: AW5-1-N (New opal, light trans. >74%)
- Code: AW5-1-F (Frost, light trans. >89%)
- Code: AW5-1-C (Clear, light trans. >95%)



## Installing accessories:



Aluminium Endcap Code: AW5-1-Cap  
(without hole)



Suspension Kits  
Code: Sus.KitsA

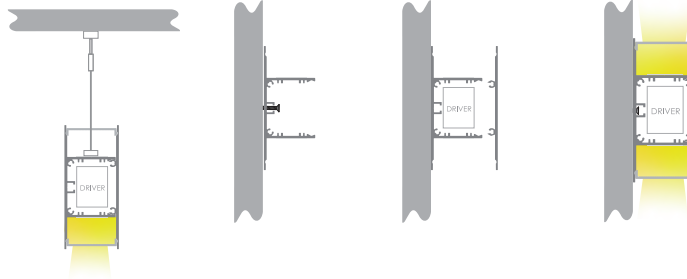

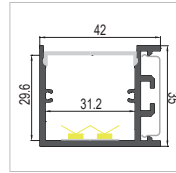
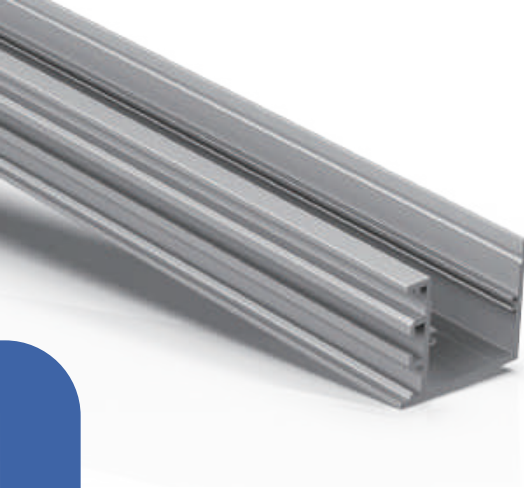

LW-AW35



## Aluminium Profile



AW35

### Specification:

Suitable for PCB 30mm

Max. LED power: 38.4w/m

Installation: Wall Surface mounted

Material: Extruded Aluminium 6063

Finish: Silver anodised, Black or White \*

Diffuser: PMMA flexible diffuser, can be 25m continuous rolled

Length: 2000mm or 2500mm continuous \*\*

Size: Profile (W) 42mm, (H) 35mm

Driver installation: Remote driver required

\* Custom powder coated colour upon request. Surcharge apply.

\*\* Profile sold per metre. Can be cut to suit any length up to 6000mm.



#### PMMA Diffuser

Code: AW35-O (Opal, light trans. >63%)

Code: AW35-N (New opal, light trans. >74%)

Code: AW35-F (Frost, light trans. >89%)

Code: AW35-C (Clear, light trans. >95%)

## Installing accessories:

	<b>Metal Clip</b> Code:MC-WN35		<b>Joiners 180°A</b> Code: J-180A
 (Optional)	<b>Screwless Endcap (with hole)</b> Code:AW35-Cap-N	 (Optional)	<b>Joiners 90°B</b> Code: J-90B
 (Optional)	<b>Joiners 90°A</b> Code: J-90A	 (Optional)	<b>Joiners 120°B</b> Code: J-120B
 (Optional)	<b>Joiners 120°A</b> Code: J-120A		

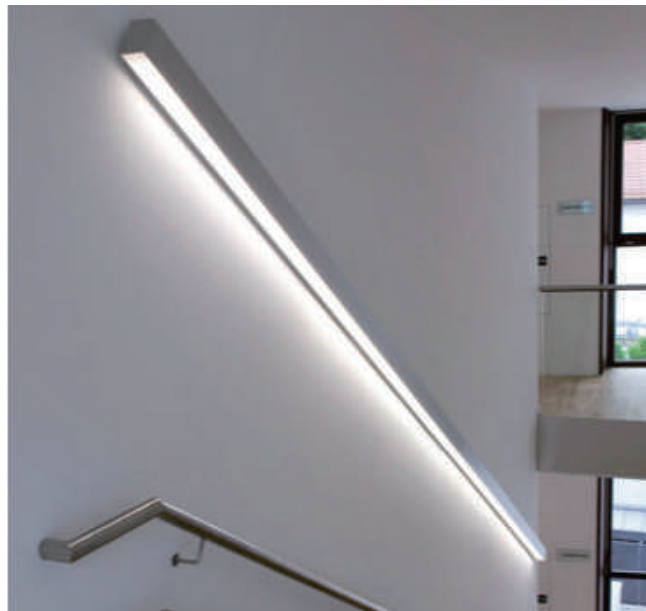
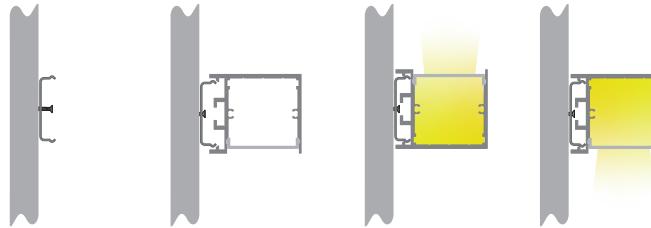

# Catalogue

- |    |                                    |    |                        |
|----|------------------------------------|----|------------------------|
| 1  | SURFACE                            | 2  | RECESSED               |
| 3  | CORNER                             | 4  | SURFACE & SUSPENSION   |
| 5  | WATERPROOF                         | 6  | STEP AND STAIR         |
| 7  | ROUND                              | 8  | WALL                   |
| 9  | <i>DRIVER BUILT-IN PROFILE</i>     | 10 | TRIMLESS-ARCHITECTURAL |
| 11 | SURFACE & SUSPENSION-ARCHITECTURAL | 12 | RECESSED-ARCHITECTURAL |
| 13 | PLASTER IN TRIMLESS                | 14 | BEND & CURVED          |

# DRIVER BUILT-IN PROFILE

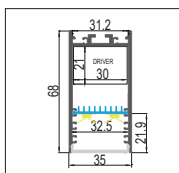
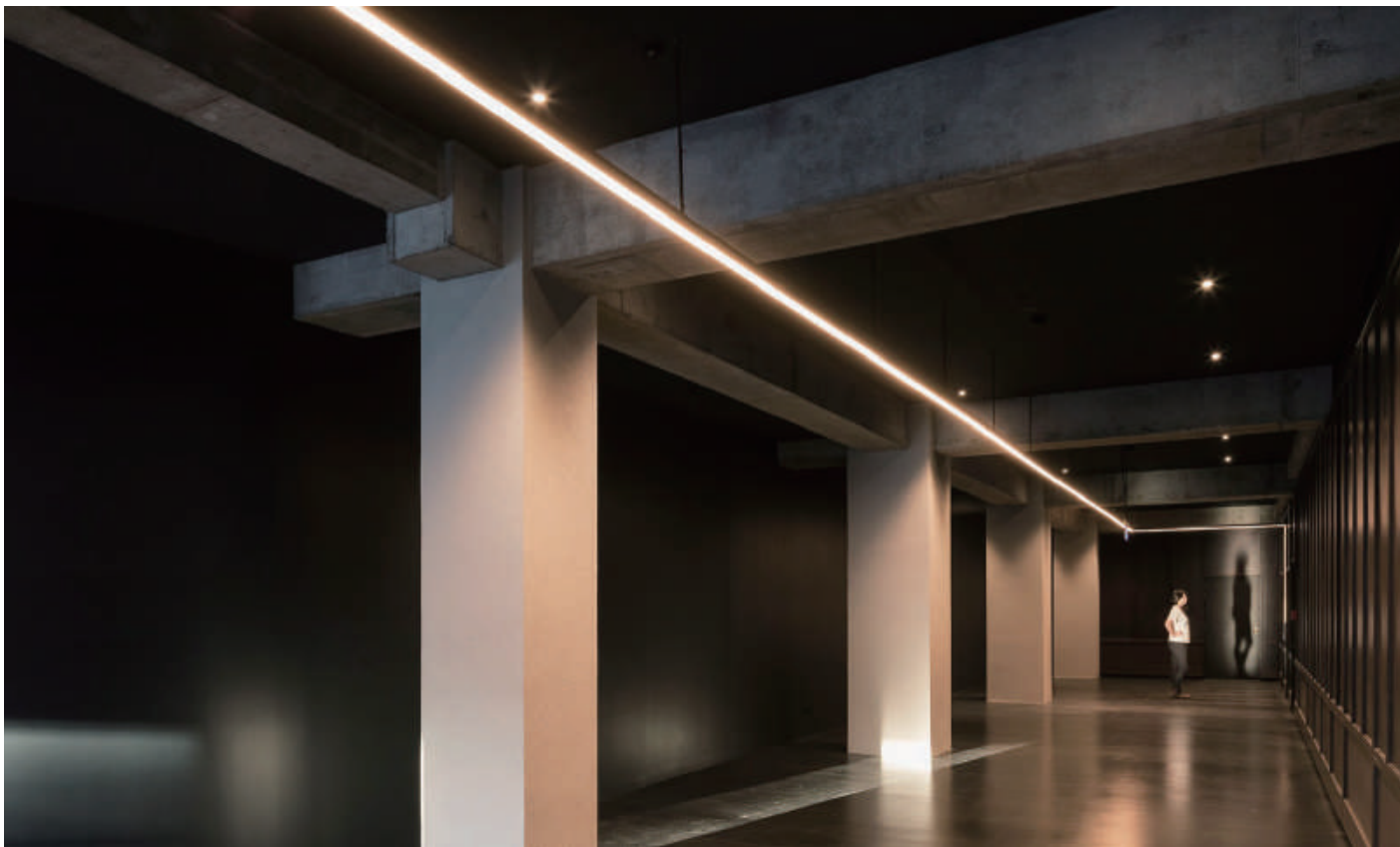

**LW-P35**  
Page 126

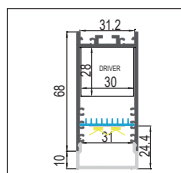

**LW-PU35**  
Page 126

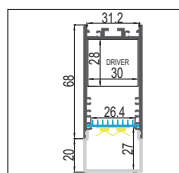

**LW-PUH35**  
Page 126

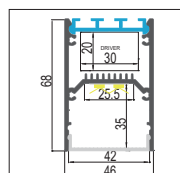

**LW-P46**  
Page 128

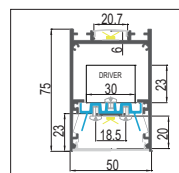

**LW-P50N**  
Page 130

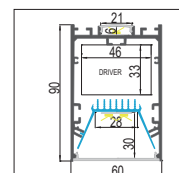

**LW-P60**  
Page 132

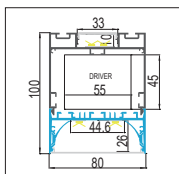

**LW-EH80**  
Page 134

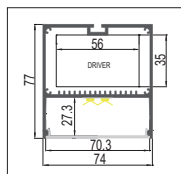

**LW-P74**  
Page 136

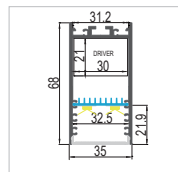
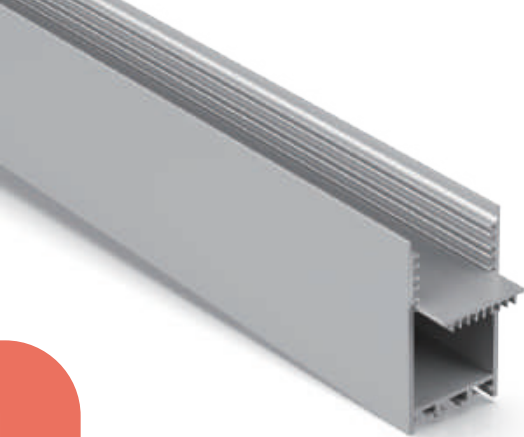

LW-P35

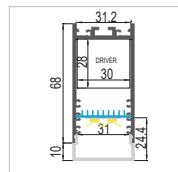

LW-PU35

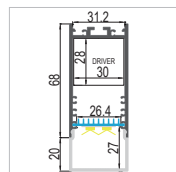

LW-PUH35

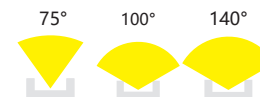

### Specification:

Suitable for PCB 30mm

Max. LED power: 38.4w/m

Installation: Surface /Suspended

Material: Extruded Aluminium 6063

Finish: Silver anodised, Black or White \*

Diffuser: PMMA flexible diffuser, can be 25m continuous rolled(p35)

Length: 2000mm or 2500mm continuous \*\*

Size: Profile (W) 35mm, (H) 68mm

Driver installation: Remote or integral driver required

\* Custom powder coated colour upon request. Surcharge apply.

\*\* Profile sold per metre. Can be cut to suit any length up to 6000mm.

## Aluminium Profile



P35

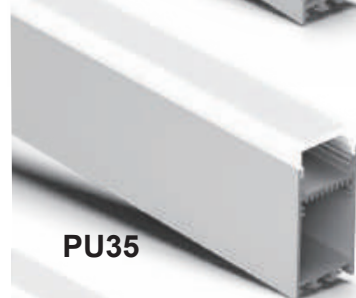

PU35



PUH35



#### PMMA Diffuser

- Code: P35-O (Opal, light trans. >63%)
- Code: P35-N (New opal, light trans. >74%)
- Code: P35-F (Frost, light trans. >89%)
- Code: P35-C (Clear, light trans. >95%)



#### Black Diffuser

- Code: WN31-B (Black, light trans. > 22%)
- MOQ: 200M



#### PMMA Diffuser

- Code: PU35-O (Opal, light trans. >60%)



#### PMMA Diffuser

- Code: PUH35-O (Opal, light trans. >60%)

## Installing accessories:

	<b>Aluminium Endcap</b> (without hole) Code: P35-Cap		<b>Suspension Kits</b> Code: Sus.KitsA
	<b>Aluminium Endcap</b> (without hole) Code: PU35-Cap		<b>Wall Clips</b> Code: WN35-WClip
	<b>Aluminium Endcap</b> (without hole) Code: PUH35-Cap		<b>Joiners 90°A</b> Code: J-90A
	<b>Joiners 180°A</b> Code: J-180A		<b>CNC Aluminum Cap</b> (without hole) Code: P35-Cap-N
	<b>Dali &amp; Push Dimmable LED Driver</b> 30/36/60/100W Code:LW-SCD		<b>Metal Clip</b> Code: P35-Clip-M
	<b>Standard IP67 Led Powersupply</b> 20/30/36/45/60W Code: LW-HLD		<b>Joiners 120°A</b> Code: J-120A

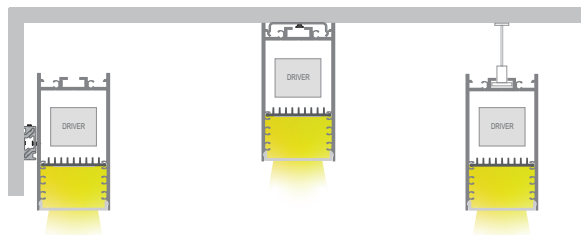

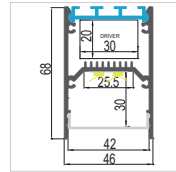

LW-P46

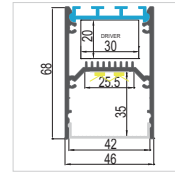

LW-P46



**Specification:**

Suitable for PCB 25mm	
Max. LED power: 38.4w/m	
Installation:	Surface /Suspended
Material:	Extruded Aluminium 6063
Finish:	Silver anodised, Black or White *
Diffuser:	PMMA flexible diffuser, can be 25m continuous rolled
Length:	2000mm or 2500mm continuous **
Size:	Profile (W) 46mm, (H) 68.5mm
Driver installation: Remote or integral driver required	
* Custom powder coated colour upon request. Surcharge apply.	
** Profile sold per metre. Can be cut to suit any length up to 6000mm.	

**Aluminium Profile**

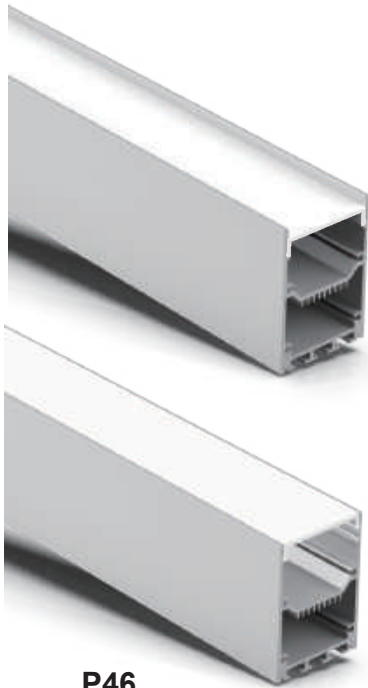

**P46**

Extrusive in Australia







**PMMA Diffuser**

Code: P46-O (Opal, light trans. >60%)

Driver built-in Series



## Installing accessories:

	<b>Aluminium Endcap</b> (without hole) Code: P46-Cap		<b>Suspension Kits</b> Code: Sus.KitsA
 (Optional)	<b>CNC Aluminum Cap</b> (without hole) Code: P46-Cap-N	 (Optional)	<b>Wall Clips</b> Code: WClip
 (Optional)	<b>Joiners 180°A</b> Code: J-180A	 (Optional)	<b>Joiners 90°A</b> Code: J-90A
 (Optional)	<b>Dali &amp; Push Dimmable LED Driver</b> 30/36/60W Code:LW-SCD	 (Optional)	<b>Joiners 120°A</b> Code: J-120A
 (Optional)	<b>Standard IP67 Led Powersupply</b> 20/30/36/45/60W Code: LW-HLD		

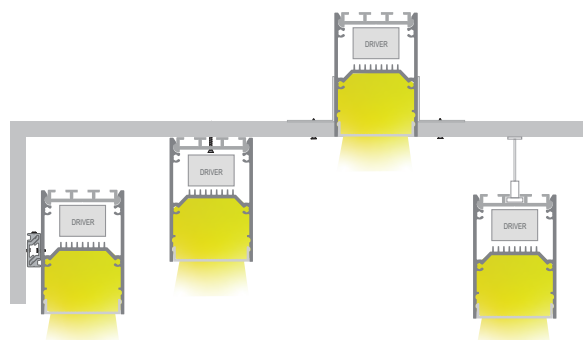

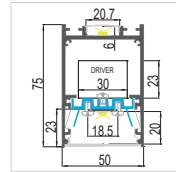

LW-P50N



## Aluminium Profile

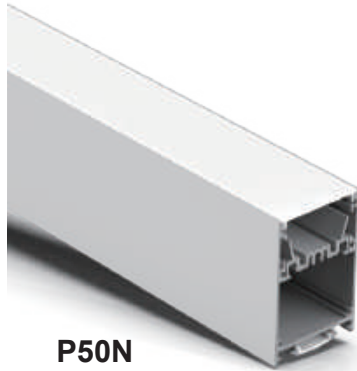

P50N

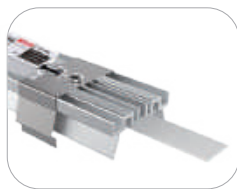

### PMMA Diffuser (Down)

Code: P50N-O (Opal, light trans. >60%)  
Code: P50N-N (New opal, light trans. >74%)



### PMMA Diffuser (Up)

Code: P50N-O (Opal, light trans. >60%)  
Code: P50N-N (New opal, light trans. >74%)



### Black Diffuser

Code: E50-B (Black, light trans. >22%)  
MOQ: 200M

## Specification:

Suitable for PCB 18mm

Max. LED power: 57.6w/m

Installation: Surface /Suspended

Material: Extruded Aluminium 6063

Finish: Silver anodised, Black or White \*

Diffuser: PMMA flexible diffuser, can be 25m continuous rolled

Length: 2000mm or 2500mm continuous \*\*

Size: Profile (W) 50mm, (H) 75mm

Driver installation: Remote or integral driver required

\* Custom powder coated colour upon request. Surcharge apply.

\*\* Profile sold per metre. Can be cut to suit any length up to 6000mm.

## Installing accessories:

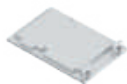

**Aluminum Screwless Endcap**  
(without hole)  
Code: P50N-Cap-N



**Suspension Kits**  
Code: Sus.KitsB



**Metal Clip**  
Code: P50N-Clip-M

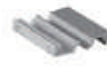

**Wall Clips**  
Code: WClip



(Optional)

**Stainless Steel L bracket**  
Code: LW-LMB



(Optional)

**Joiners 90°A**  
Code: J-90A



(Optional)

**Joiners 90°B**  
Code: J-90B



(Optional)

**Joiners 120°A**  
Code: J-120A



(Optional)

**Dali & Push Dimmable LED Driver**  
30/36/60/100W  
Code:LW-SCD



(Optional)

**Joiners 180°A**  
Code: J-180A



(Optional)

**Standard IP67 Led Powersupply**  
20/30/36/45/60W  
Code: LW-HLD



(Optional)

**Joiners 120°B**  
Code: J-120B



(Optional)

**Gear Tray Clip**  
Code: P50N-Clip

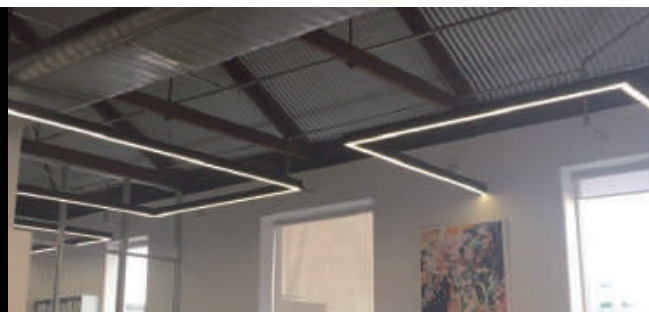
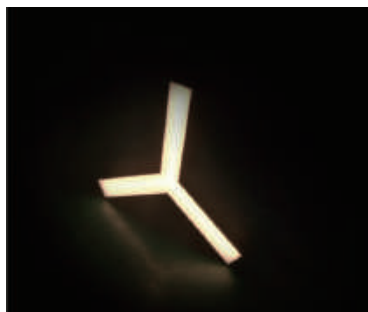
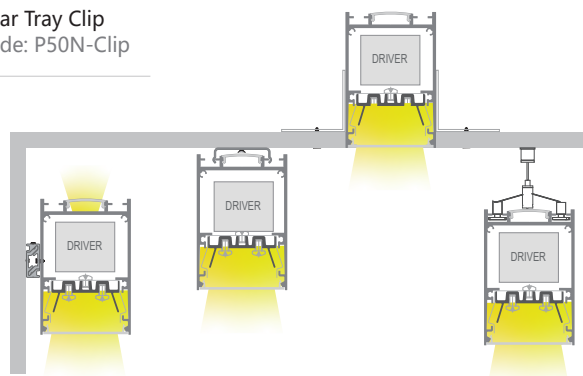

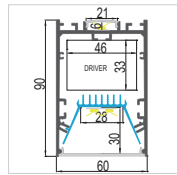

LW-P60



## Aluminium Profile



P60



(For Zhaga Led PCB board), hole-free design

### Specification:

Suitable for PCB 28mm

Max. LED power: 57.6w/m

Installation: Surface /Suspended

Material: Extruded Aluminium 6063

Finish: Silver anodised, Black or White \*

Diffuser: PMMA flexible diffuser, can be 25m continuous rolled

Length: 2000mm or 2500mm continuous \*\*

Size: Profile (W) 50mm, (H) 75mm

Driver installation: Remote or integral driver required

\* Custom powder coated colour upon request. Surcharge apply.

\*\* Profile sold per metre. Can be cut to suit any length up to 6000mm.



#### PMMA Diffuser (Down)

Code: P60-N (New opal, light trans. >74%)



#### PMMA Diffuser (Up)

Code: AS3-O (New opal, light trans. >74%)

## Installing accessories:

(Optional)	<b>Aluminium Endcap</b> (without hole) Code: P60-Cap	(Optional)	<b>Suspension Kits</b> Code: Sus.KitsB
(Optional)	<b>CNC Aluminum Cap</b> (without hole) Code: P60-Cap-N	(Optional)	<b>Wall Clips</b> Code: WClip
(Optional)	<b>Joiners 180°A</b> Code: J-180A	(Optional)	<b>Joiners 90°A</b> Code: J-90A
(Optional)	<b>Joiners 90°B</b> Code: J-90B	(Optional)	<b>Joiners 120°A</b> Code: J-120A
(Optional)	<b>Dali &amp; Push Dimmable LED Driver</b> 30/36/60/100W Code:LW-SCD	(Optional)	<b>Joiners 120°B</b> Code: J-120B
(Optional)	<b>Standard IP67 Led Powersupply</b> 20/30/36/45/60W Code: LW-HLD		

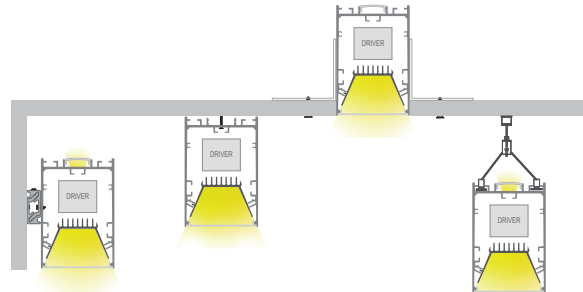

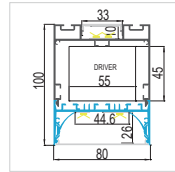

LW-EH80



## Aluminium Profile

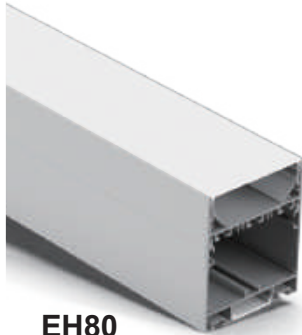

EH80

### Specification:

Suitable for PCB 44mm

Max. LED power: 57.6w/m

Installation: Surface /Suspended

Material: Extruded Aluminium 6063

Finish: Silver anodised, Black or White \*

Diffuser: PMMA flexible diffuser, can be 25m continuous rolled

Length: 2000mm or 2500mm continuous \*\*

Size: Profile (W) 80mm, (H) 100mm

Driver installation: Remote or integral driver required

\* Custom powder coated colour upon request. Surcharge apply.

\*\* Profile sold per metre. Can be cut to suit any length up to 6000mm.



#### PMMA Diffuser (Down)

Code: EH80-N (New opal, light trans. >74%)



#### PMMA Diffuser (Up)

Code: EH80-N (New opal, light trans. >74%)

## Installing accessories:

	<b>Aluminium Endcap</b> (without hole) Code: EH80-Cap		<b>Suspension Kits</b> Code: Sus.KitsB
	<b>Aluminum Screwless Endcap</b> (without hole) Code: EH80-Cap-N		<b>Wall Clips</b> Code: WClip
	<b>Joiners 90°A</b> Code: J-90A		<b>Joiners 90°B</b> Code: J-90B
	<b>Joiners 120°A</b> Code: J-120A		<b>Joiners 120°B</b> Code: J-120B
	<b>Dali &amp; Push Dimmable LED Driver</b> 30/36/60/100W Code:LW-SCD		<b>Joiners 180°A</b> Code: J-180A
	<b>Standard IP67 Led Powersupply</b> 20/30/36/45/60W Code: LW-HLD		

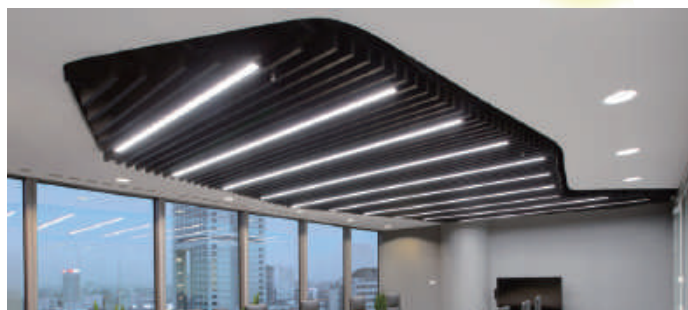
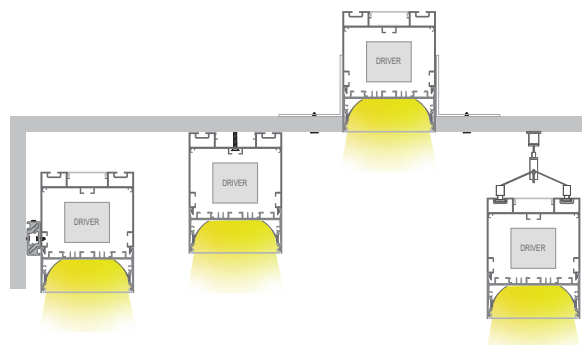

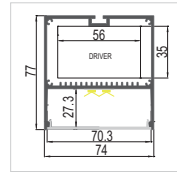

LW-P74



105°

## Aluminium Profile

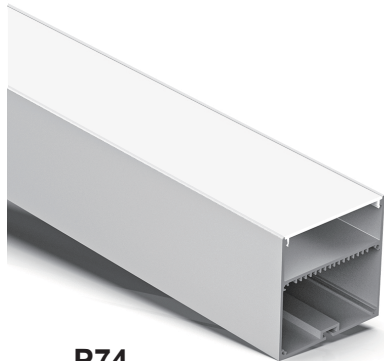

P74

### Specification:

Suitable for PCB 70mm	
Max. LED power:	57.6w/m
Installation:	Surface /Suspended
Material:	Extruded Aluminium 6063
Finish:	Silver anodised, Black or White *
Diffuser:	PMMA flexible diffuser, can be 25m continuous rolled
Length:	2000mm or 2500mm continuous **
Size:	Profile (W) 74mm, (H) 77mm
Driver installation:	Remote or integral driver required
* Custom powder coated colour upon request. Surcharge apply.	
** Profile sold per metre. Can be cut to suit any length up to 6000mm.	









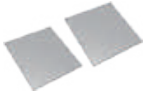

#### PMMA Diffuser

Code: P74-N (New opal, light trans. >77%)



## Installing accessories:

	<b>Aluminium Endcap</b> (without hole) Code: P70-Cap		<b>Suspension Kits</b> Code: Sus.KitsA
 (Optional)	<b>Joiners 90°A</b> Code: J-90A	 (Optional)	<b>Wall Clips</b> Code: WClip
 (Optional)	<b>Dali &amp; Push Dimmable LED Driver</b> 30/36/60/100W Code:LW-SCD	 (Optional)	<b>Joiners 180°A</b> Code: J-180A
 (Optional)	<b>Standard IP67 Led Powersupply</b> 20/30/36/45/60W Code: LW-HLD	 (Optional)	<b>Joiners 120°A</b> Code: J-120A

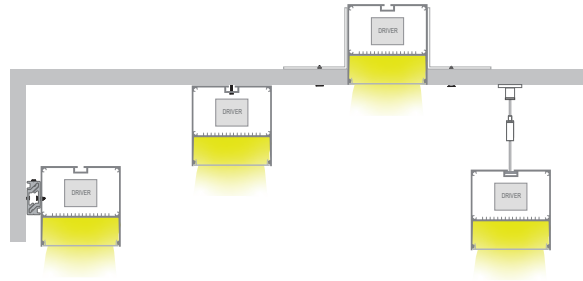

# Catalogue

- |    |                                    |           |                               |
|----|------------------------------------|-----------|-------------------------------|
| 1  | SURFACE                            | 2         | RECESSED                      |
| 3  | CORNER                             | 4         | SURFACE & SUSPENSION          |
| 5  | WATERPROOF                         | 6         | STEP AND STAIR                |
| 7  | ROUND                              | 8         | WALL                          |
| 9  | DRIVER BUILT-IN PROFILE            | <b>10</b> | <b>TRIMLESS-ARCHITECTURAL</b> |
| 11 | SURFACE & SUSPENSION-ARCHITECTURAL | 12        | RECESSED-ARCHITECTURAL        |
| 13 | PLASTER IN TRIMLESS                | 14        | BEND & CURVED                 |

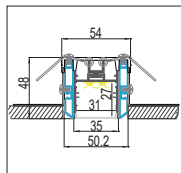

**LW-TR35**  
Page 140

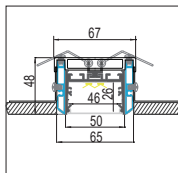

**LW-TR50**  
Page 142

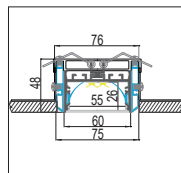

**LW-TR60**  
Page 144

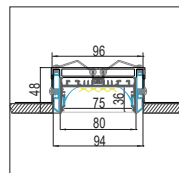

**LW-TR80**  
Page 146

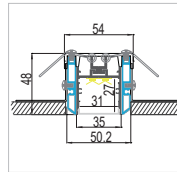
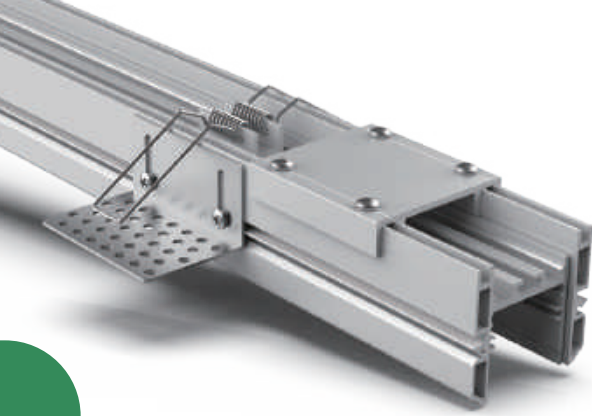

LW-TR35



### Specification:

Suitable for PCB 30mm

Max. LED power: 28.8w/m

Installation: Ceiling trimless

Material: Extruded Aluminium 6063

Finish: Silver anodised, Black or White \*

Diffuser: PMMA flexible diffuser, can be 25m continuous rolled

Length: 2000mm or 2500mm continuous \*\*

Size: Profile (W) 54mm, (H) 48mm

Driver installation: Remote driver required

\* Custom powder coated colour upon request. Surcharge apply.

\*\* Profile sold per metre. Can be cut to suit any length up to 6000mm.

## Aluminium Profile



TR35

#### PMMA Diffuser

Code: TR35-O (Opal, light trans. >63%)









Code: TR35-N (New opal, light trans. >74%)

Code: TR35-F (Frost, light trans. >89%)

Code: TR35-C (Clear, light trans. >95%)



## Installing accessories:

	<b>Aluminium Endcap</b> (without hole) Code: TR35-Cap		<b>Aluminium Endcap</b> (without hole) Code: TR35-Cap
	<b>Stainless Steel L bracket</b> Code: LW-LMB		<b>Alum. bridge base</b> Code: LW-TR35
	<b>Spring Clip</b> Code: SC-WN31	 (Optional)	<b>Joiners 180°A</b> Code: J-180A
 (Optional)	<b>Joiners 90°A</b> Code: J-90A	 (Optional)	<b>Joiners 120°A</b> Code: J-120A

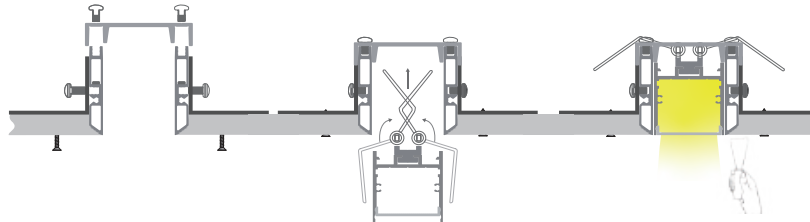

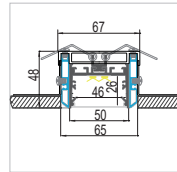
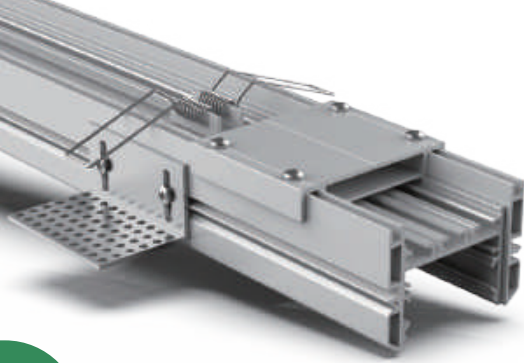

LW-TR50



### Specification:

Suitable for PCB	45mm
Max. LED power:	38.4w/m
Installation:	Ceiling trimless
Material:	Extruded Aluminium 6063
Finish:	Silver anodised, Black or White*
Diffuser:	PMMA flexible diffuser, can be 25m continuous rolled
Length:	2000mm or 2500mm continuous**
Size:	Profile (W) 67mm, (H) 48mm
Driver installation:	Remote driver required
* Custom powder coated colour upon request. Surcharge apply.	
** Profile sold per metre. Can be cut to suit any length up to 6000mm.	

## Aluminium Profile

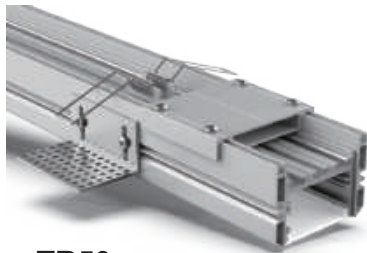

TR50









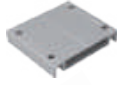

#### PMMA Diffuser

Code: TR50-O (Opal, light trans. >60%)

Code: TR50-N (New opal, light trans. >77%)

## Installing accessories:

	<b>Aluminium Endcap</b> (without hole) Code: TR50-Cap		<b>Aluminium Endcap</b> (without hole) Code: TR50-Cap
	<b>Stainless Steel L bracket</b> Code: LW-LMB		<b>Alum. bridge base</b> Code: LW-TR50
	<b>Spring Clip</b> Code: SC-WN31	 (Optional)	<b>Joiners 180°A</b> Code: J-180A
 (Optional)	<b>Joiners 90°A</b> Code: J-90A	 (Optional)	<b>Joiners 180°B</b> Code: J-180B
 (Optional)	<b>Joiners 120°A</b> Code: J-120A		

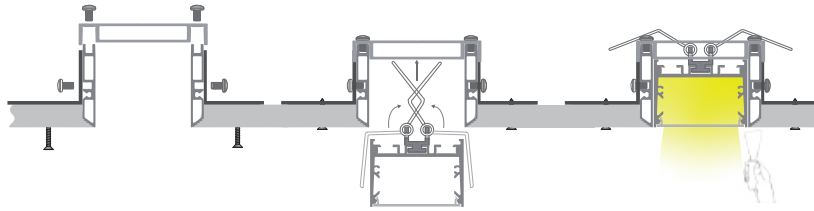

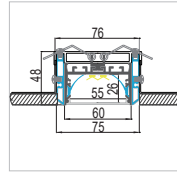
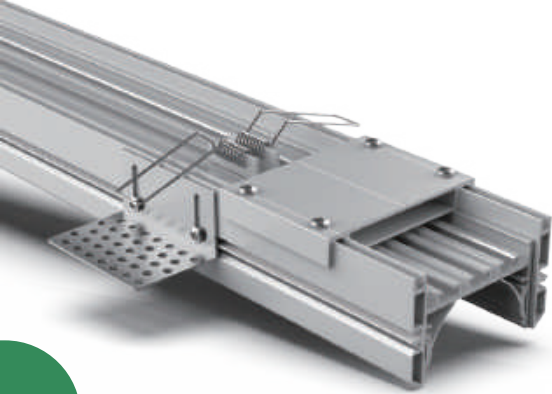

LW-TR60



### Specification:

Suitable for PCB 55mm

Max. LED power: 57.6w/m

Installation: Ceiling trimless

Material: Extruded Aluminium 6063

Finish: Silver anodised, Black or White \*

Diffuser: PMMA flexible diffuser, can be 25m continuous rolled

Length: 2000mm or 2500mm continuous \*\*

Size: Profile (W) 76mm, (H) 48mm

Driver installation: Remote driver required

\* Custom powder coated colour upon request. Surcharge apply.

\*\* Profile sold per metre. Can be cut to suit any length up to 6000mm.

## Aluminium Profile



TR60



### PMMA Diffuser

Code: TR60-N (New opal, light trans. >74%)



## Installing accessories:



**Aluminium Endcap** Code: TR60-Cap  
(without hole)



**Aluminum Endcap**  
(without hole) Code: TR60-Cap



**Stainless Steel L bracket**  
Code: LW-LMB



**Alum. bridge base**  
Code: LW-TR60



**Spring Clip**  
Code: SC-WN31



**Joiners 180°A**  
Code: J-180A



**Joiners 90°A**  
Code: J-90A



**Joiners 180°B**  
Code: J-180B



**Joiners 120°A**  
Code: J-120A

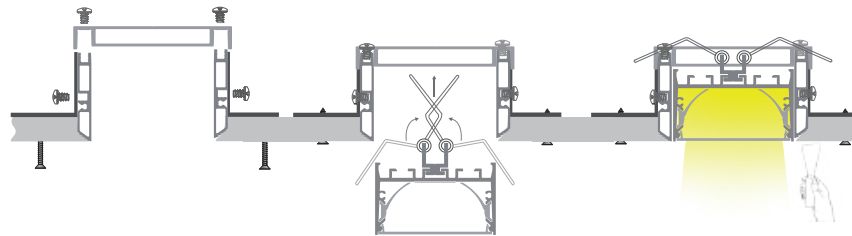

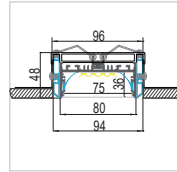
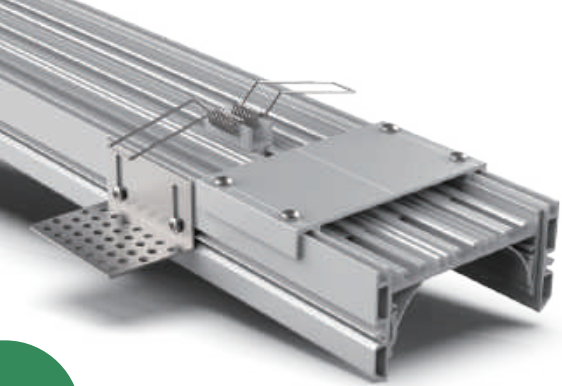

LW-TR80



### Specification:

Suitable for PCB 75mm

Max. LED power: 57.6w/m

Installation: Ceiling trimless

Material: Extruded Aluminium 6063

Finish: Silver anodised, Black or White \*

Diffuser: PMMA flexible diffuser, can be 25m continuous rolled

Length: 2000mm or 2500mm continuous \*\*

Size: Profile (W) 96mm, (H) 48mm

Driver installation: Remote driver required

\* Custom powder coated colour upon request. Surcharge apply.

\*\* Profile sold per metre. Can be cut to suit any length up to 6000mm.

## Aluminium Profile

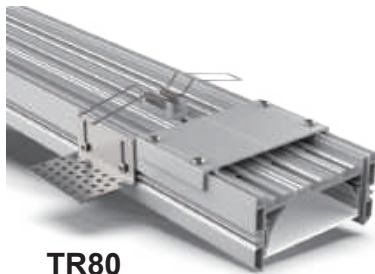

TR80



### PMMA Diffuser

Code: TR80-N (New opal, light trans. >74%)

## Installing accessories:



**Aluminium Endcap** Code: TR80-Cap  
(without hole)



**Aluminum Endcap**  
(without hole) Code: TR80-Cap



**Stainless Steel L bracket**  
Code: LW-LMB



**Alum. bridge base**  
Code: LW-TR80



**Spring Clip**  
Code: SC-WN31



(Optional)

**Joiners 180°A**  
Code: J-180A



(Optional)

**Joiners 90°A**  
Code: J-90A



(Optional)

**Joiners 180°B**  
Code: J-180B



(Optional)

**Joiners 120°A**  
Code: J-120A

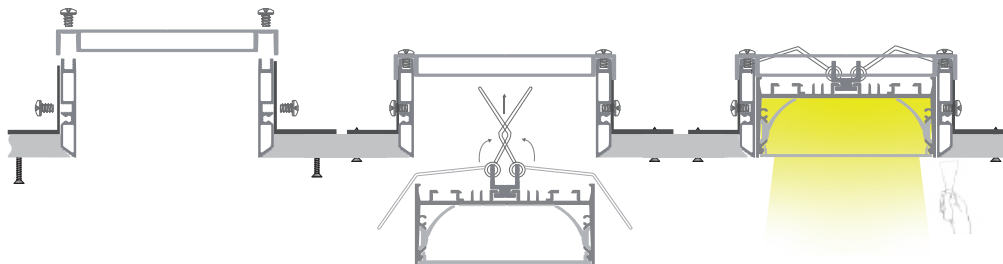

# Catalogue

- |           |  |    |                        |
|-----------|--|----|------------------------|
| 1         | SURFACE  | 2  | RECESSED               |
| 3         | CORNER   | 4  | SURFACE & SUSPENSION   |
| 5         | WATERPROOF   | 6  | STEP AND STAIR         |
| 7         | ROUND  | 8  | WALL                   |
| 9         | DRIVER BUILT-IN PROFILE                              | 10 | TRIMLESS-ARCHITECTURAL |
| <b>11</b> | <b><i>SURFACE &amp; SUSPENSION-ARCHITECTURAL</i></b> | 12 | RECESSED-ARCHITECTURAL |
| 13        | PLASTER IN TRIMLESS                                  | 14 | BEND & CURVED          |

# SURFACE & SUSPENSION-ARCHITECTURAL

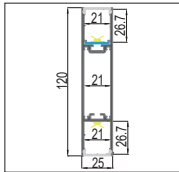

LW-P24  
Page 150

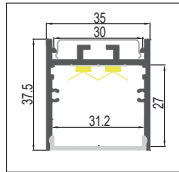

LW-WN35  
Page 152

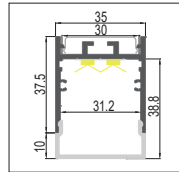

LW-WU35  
Page 152

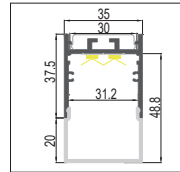

LW-WUH35  
Page 152

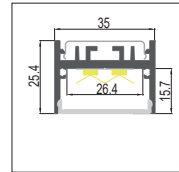

LW-WN35-25  
Page 154

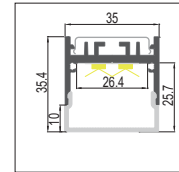

LW-WU35-25  
Page 154

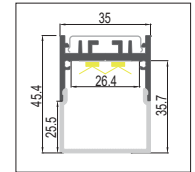

LW-WUH35-25  
Page 154

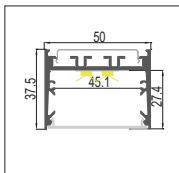

LW-E50  
Page 156

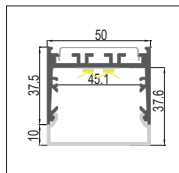

LW-EU50  
Page 156

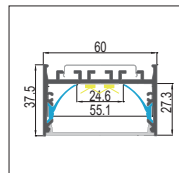

LW-E60  
Page 158

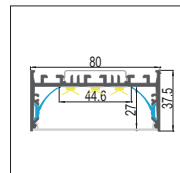

LW-E80  
Page 160

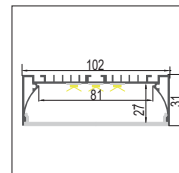

LW-E100  
Page 162

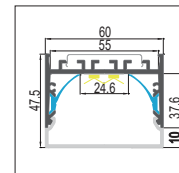

LW-EU60  
Page 158

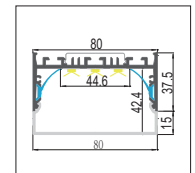

LW-EU80  
Page 160

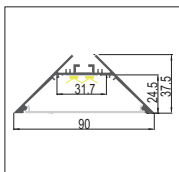

LW-W91  
Page 164



**Aluminium Profile**



**P24**

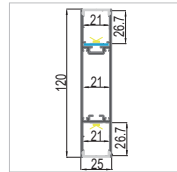

LW-P24



**Specification:**







Suitable for PCB 24mm	
Max. LED power:	38.4*2w/m
Installation:	Surface /Suspended
Material:	Extruded Aluminium 6063
Finish:	Silver anodised, Black or White *
Diffuser:	PMMA flexible diffuser, can be 25m continuous rolled
Length:	2000mm or 2500mm continuous**
Size:	Profile (W) 25mm, (H) 120mm
Driver installation:	Remote driver required
* Custom powder coated colour upon request. Surcharge apply.	
** Profile sold per metre. Can be cut to suit any length up to 4000mm.	



**PMMA Diffuser**

Code: P24-O (Opal, light trans. >55%)

## Installing accessories:

	<b>Screwless aluminum Cap</b> (without hole) Code: P24-Cap-N		<b>Suspension Kits</b> Code: Sus.KitsA
 (Optional)	<b>Wall Clips</b> Code: WClip	 (Optional)	<b>Joiners 90°A</b> Code: J-90A
 (Optional)	<b>Joiners 180°A</b> Code: J-180A	 (Optional)	<b>Joiners 120°A</b> Code: J-120A

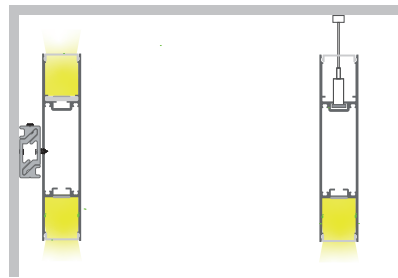

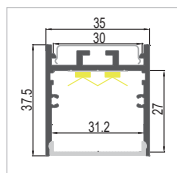
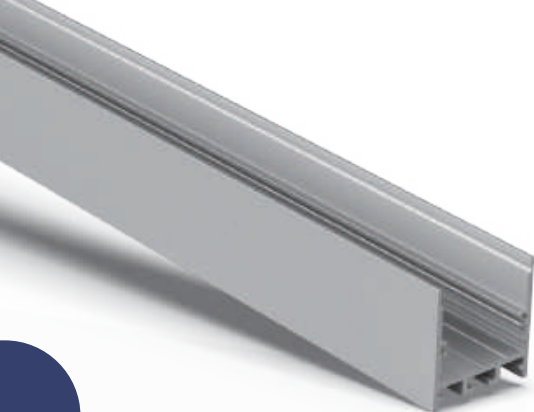

LW-WN35

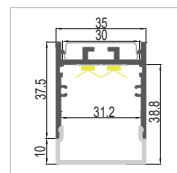

LW-WU35

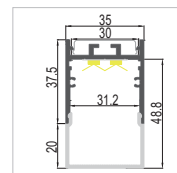

LW-WUH35



### Aluminium Profile



WN35



WU35



WUH35

### Specification:

Suitable for PCB 20mm / 30mm / 30mm

Max. LED power: 38.4w/m

Installation: Surface /Suspended

Material: Extruded Aluminium 6063

Finish: Silver anodised, Black or White \*

Diffuser: PMMA flexible diffuser, can be 25m continuous rolled (WN35)

Length: 2000mm or 2500mm continuous \*\*

Size: Profile (W) 35mm, (H) 37.5mm

Driver installation: Remote driver required

\* Custom powder coated colour upon request. Surcharge apply.

\*\* Profile sold per metre. Can be cut to suit any length up to 6000mm.



#### PMMA Diffuser

- Code: WN35-O (Opal, light trans. >63%)
- Code: WN35-N (New opal, light trans. >74%)
- Code: WN35-F (Frost, light trans. >89%)
- Code: WN35-C (Clear, light trans. >95%)



#### Black Diffuser

- Code: WN31-B (Black, light trans. > 22%)
- MOQ: 200M



#### PMMA Diffuser

- Code: WU35-O (Opal, light trans. >60%)



#### PMMA Diffuser

- Code: WUH35-O (Opal, light trans. > 60%)



## Installing accessories:



**Aluminium Endcap** Code: WN35-Cap  
(with/without hole) Code: WN35-Cap-H



**Suspension Kits**  
Code: Sus.KitsA



**Aluminium Endcap** Code: WU35-Cap  
(without hole)



**Wall Clips**  
Code: WClip-WN-35



**Aluminium Endcap** Code: WUH35-Cap  
(without hole)

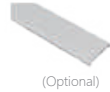

**Aluminium diffuser**  
Code: WN35-AD



(Optional)

**Aluminum Screwless Endcap**  
(with/without hole) Code: WN35-Cap-N



(Optional)

**Joiners 90°A**  
Code: J-90A



(Optional)

**Joiners 120°A**  
Code: J-120A



(Optional)

**Joiners 180°A**  
Code: J-180A



(Optional)

**Metal Clip**  
Code: MC-WN35

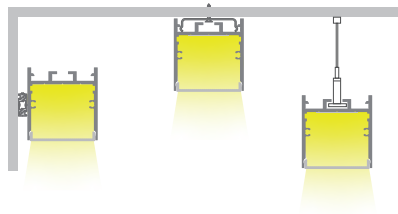

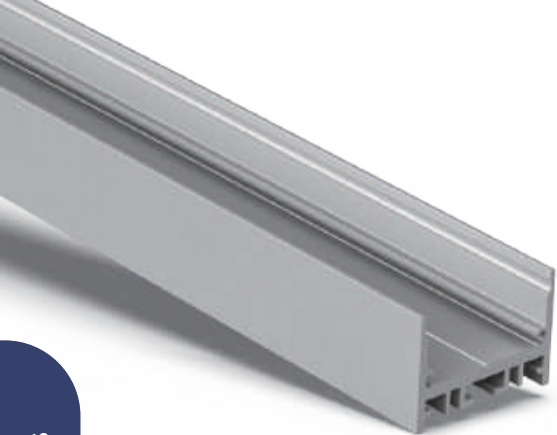

**Aluminium Profile**



**WN35-25**



**WU35-25**



**WUH35-25**

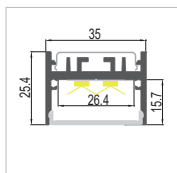

LW-WN35-25

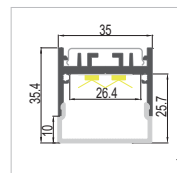

LW-WU35-25

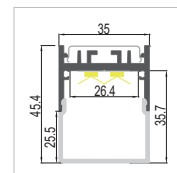

LW-WUH35-25



**Specification:**

Suitable for PCB 30mm / 25mm / 25mm

Max. LED power: 38.4w/m

Installation: Surface /Suspended

Material: Extruded Aluminium 6063

Finish: Silver anodised, Black or White \*

Diffuser: PMMA flexible diffuser, can be 25m continuous rolled (WN35-25)

Length: 2000mm or 2500mm continuous \*\*

Size: Profile (W) 35mm, (H) 25.4mm

Driver installation: Remote driver required

\* Custom powder coated colour upon request. Surcharge apply.

\*\* Profile sold per metre. Can be cut to suit any length up to 6000mm.



**PMMA Diffuser**

- Code: WN35-25-O (Opal, light trans. >63%)
- Code: WN35-25-N (New opal, light trans. >74%)
- Code: WN35-25-F (Frost, light trans. >89%)
- Code: WN35-25-C (Clear, light trans. >95%)



**PMMA Diffuser**

- Code: WU35-25-O (Opal, light trans. >63%)



**PMMA Diffuser**

- Code: WUH35-25-O (Opal, light trans. >60%)

## Installing accessories:

	<b>Aluminium Endcap</b> (with/without hole) Code: WN35-25-Cap Code: WN35-25-Cap-H		<b>Suspension Kits</b> Code: Sus.KitsA
	<b>Aluminium Endcap</b> (without hole) Code: WU35-25-Cap	 (Optional)	<b>Metal Clip</b> Code: MC-WN35
	<b>Aluminium Endcap</b> (without hole) Code: WUH35-25-Cap	 (Optional)	<b>Joiners 90°A</b> Code: J-90A
 (Optional)	<b>Joiners 120°A</b> Code: J-120A	 (Optional)	<b>Joiners 180°A</b> Code: J-180A

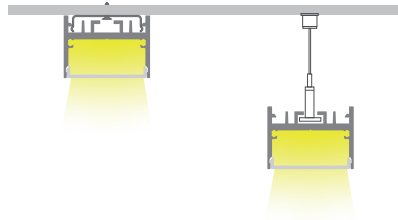



**Aluminium Profile**



**E50**



**EU50**

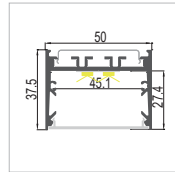

LW-E50

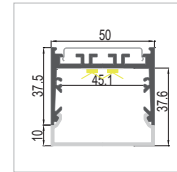

LW-EU50



**Specification:**

Suitable for PCB	40mm / 30mm
Max. LED power:	38.4w/m / 57.6w/m
Installation:	Surface /Suspended
Material:	Extruded Aluminium 6063
Finish:	Silver anodised, Black or White *
Diffuser:	PMMA flexible diffuser, can be 25m continuous rolled (E50)
Length:	2000mm or 2500mm continuous **
Size:	Profile (W) 50mm, (H) 37.5mm
Driver installation:	Remote driver required

\* Custom powder coated colour upon request. Surcharge apply.

\*\* Profile sold per metre. Can be cut to suit any length up to 6000mm.



**PMMA Diffuser**

Code: E50-O (Opal, light trans. >60%)

Code: E50-N (New opal, light trans. >74%)



**Black Diffuser**

Code: E50-B (Black, light trans. >22%)

MOQ: 200M



**PMMA Diffuser**

Code: EU50-O (Opal, light trans. >60%)

## Installing accessories:



**Aluminium Endcap** Code: E50-Cap  
(with/without hole) Code: E50-Cap-H



**Suspension Kits**  
Code: Sus.KitsA



**Aluminium Endcap** Code: EU50-Cap  
(with/without hole) Code: EU50-Cap-H



**Wall Clips**  
Code: WClip



(Optional)

**Screwless aluminum Cap**  
(with/without hole) Code: E50-Cap-N



(Optional)

**Aluminium diffuser**  
Code: E50-AD



(Optional)

**Joiners 90°A**  
Code: J-90A



(Optional)

**Joiners 180°B**  
Code: J-180B



(Optional)

**Joiners 120°A**  
Code: J-120A



(Optional)

**Joiners 180°A**  
Code: J-180A

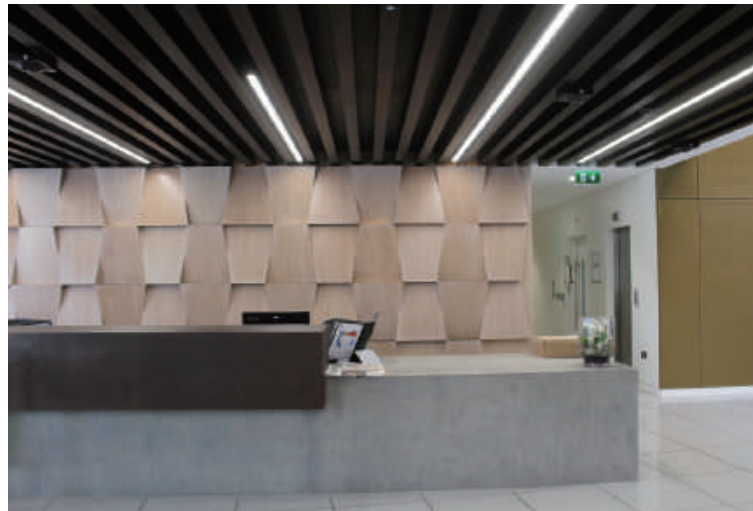
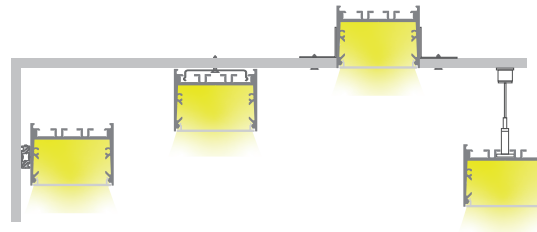

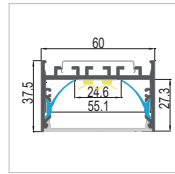

LW-E60

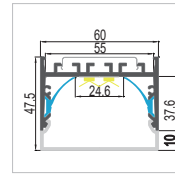

LW-EU60



## Aluminium Profile



E60

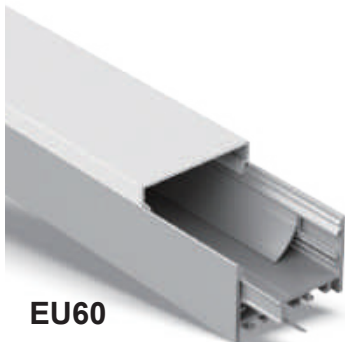

EU60



### PMMA Diffuser

Code: E60-N (New opal, light trans. >74%)



### PMMA Diffuser

Code: EU60-O (Opal, light trans. >60%)

### Specification:

Suitable for PCB 25mm / 45mm

Max. LED power: 57.6w/m

Installation: Surface /Suspended

Material: Extruded Aluminium 6063

Finish: Silver anodised, Black or White \*

Diffuser: PMMA flexible diffuser, can be 25m continuous rolled (E60)

Length: 2000mm or 2500mm continuous \*\*

Size: Profile (W) 60mm, (H) 37.5mm

Driver installation: Remote driver required

\* Custom powder coated colour upon request. Surcharge apply.

\*\* Profile sold per metre. Can be cut to suit any length up to 6000mm.

## Installing accessories:

	<b>Aluminium Endcap</b> (with/without hole) Code: E60-Cap Code: E60-Cap-H		<b>Suspension Kits</b> Code: Sus.KitsA
	<b>Aluminium Endcap</b> (with/without hole) Code: EU60-Cap Code: EU60-Cap-H		<b>Screwless aluminum Cap</b> (with/without hole) Code: E60-Cap-N
	<b>Wall Clips</b> Code: WClip-E50		<b>Screwless aluminum Cap</b> (with/without hole) Code: EU60-Cap-N
	<b>Joiners 90°A</b> Code: J-90A		<b>Joiners 90°B</b> Code: J-90B
	<b>Joiners 120°A</b> Code: J-120A		<b>Joiners 120°B</b> Code: J-120B
	<b>Joiners 180°B</b> Code: J-180B		<b>Aluminium diffuser</b> Code: E60-AD
	<b>Joiners 180°A</b> Code: J-180A		

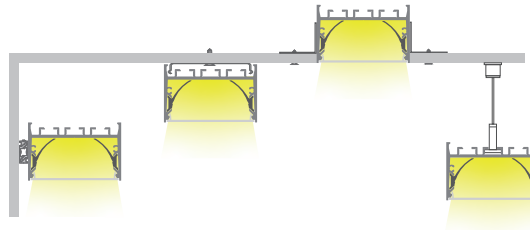

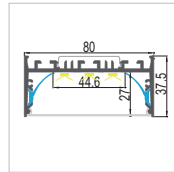

LW-E80

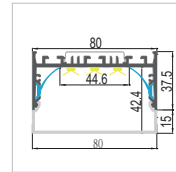

LW-EU80



## Aluminium Profile

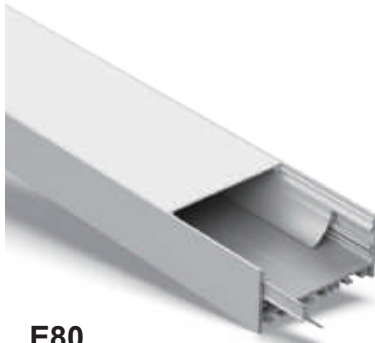

E80

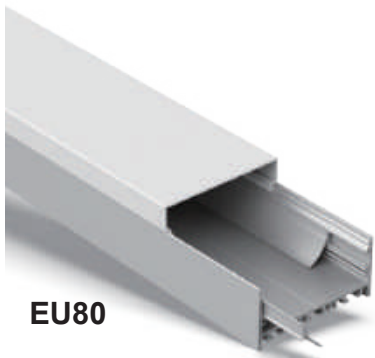

EU80



### PMMA Diffuser

Code: E80-N (New opal, light trans. >74%)



### PMMA Diffuser

Code: EU80-O (Opal, light trans. >60%)

## Specification:

Suitable for PCB 45mm / 25mm

Max. LED power: 57.6w/m

Installation: Surface /Suspended

Material: Extruded Aluminium 6063

Finish: Silver anodised, Black or White \*

Diffuser: PMMA flexible diffuser, can be 25m continuous rolled (E80)

Length: 2000mm or 2500mm continuous \*\*

Size: Profile (W) 80mm, (H) 37.5mm

Driver installation: Remote driver required

\* Custom powder coated colour upon request. Surcharge apply.

\*\* Profile sold per metre. Can be cut to suit any length up to 6000mm.



## Installing accessories:

	<b>Aluminium Endcap</b> (with/without hole) Code: E80-Cap Code: E80-Cap-H		<b>Suspension Kits</b> Code: Sus.KitsA
	<b>Aluminium Endcap</b> (with/without hole) Code: EU80-Cap Code: EU80-Cap-H		<b>Screwless aluminum Cap</b> (with/without hole) Code: E80-Cap-N
	<b>Aluminium diffuser</b> Code: E80-AD		<b>Screwless aluminum Cap</b> (with/without hole) Code: EU80-Cap-N
	<b>Wall Clips</b> Code: WClip-E50		<b>Joiners 90°B</b> Code: J-90B
	<b>Joiners 90°A</b> Code: J-90A		<b>Joiners 120°B</b> Code: J-120B
	<b>Joiners 120°A</b> Code: J-120A		<b>Joiners 180°A</b> Code: J-180A
	<b>Joiners 180°B</b> Code: J-180B		

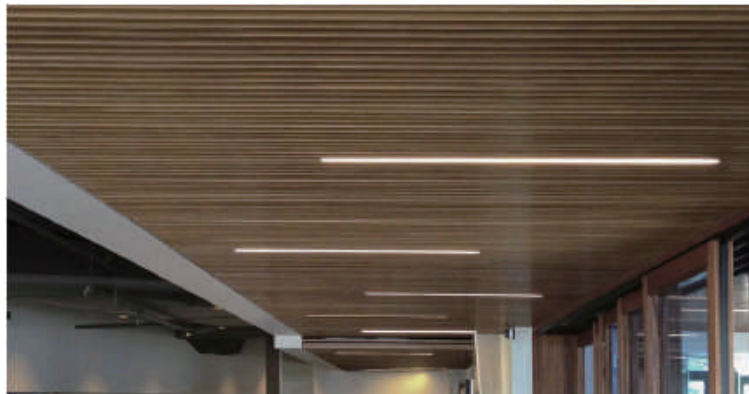
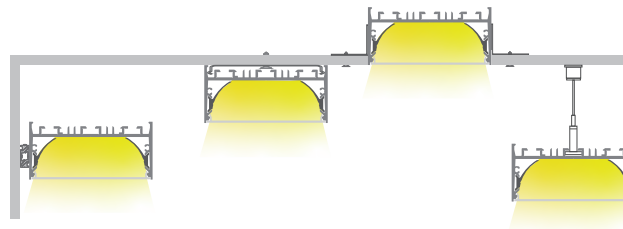

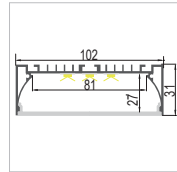

LW-E100



## Aluminium Profile



E100

### Specification:

Suitable for PCB 40mm

Max. LED power: 57.6w/m

Installation: Surface /Suspended

Material: Extruded Aluminium 6063

Finish: Silver anodised, Black or White \*

Diffuser: PC flexible diffuser

Length: 2000mm or 2500mm continuous \*\*

Size: Profile (W) 102mm, (H) 31mm

Driver installation: Remote driver required

\* Custom powder coated colour upon request. Surcharge apply.

\*\* Profile sold per metre. Can be cut to suit any length up to 4000mm.



#### PC Diffuser

Code: E100-O (Opal, light trans. >55%)

## Installing accessories:



Aluminium Endcap Code: E100-Cap  
(without hole)



Suspension Kits  
Code: Sus.KitsA

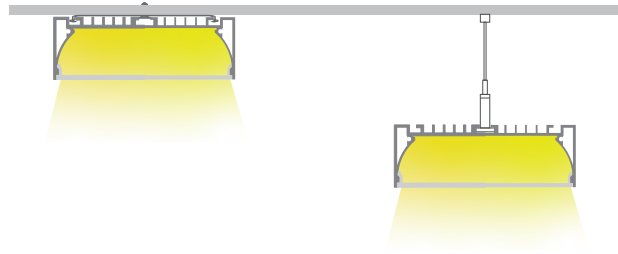



### Aluminium Profile



W91

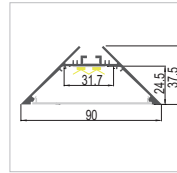

LW-W91



115°

### Specification:

Suitable for PCB 80mm	
Max. LED power:	57.6w/m
Installation:	Corner Surface /Suspended
Material:	Extruded Aluminium 6063
Finish:	Silver anodised, Black or White *
Diffuser:	PMMA flexible diffuser, can be 25m continuous rolled
Length:	2000mm or 2500mm continuous **
Size:	Profile (W) 90mm, (H) 37.5mm
Driver installation:	Remote driver required
* Custom powder coated colour upon request. Surcharge apply.	
** Profile sold per metre. Can be cut to suit any length up to 6000mm.	



### PMMA Diffuser

Code: W91-N (New opal, light trans. >74%)

## Installing accessories:



Aluminium Endcap Code: W91-Cap  
(without hole)



Suspension Kits  
Code: Sus.KitsA

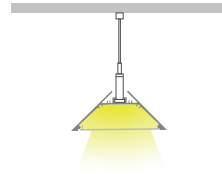

# Catalogue

- |    |                                    |           |                               |
|----|------------------------------------|-----------|-------------------------------|
| 1  | SURFACE                            | 2         | RECESSED                      |
| 3  | CORNER                             | 4         | SURFACE & SUSPENSION          |
| 5  | WATERPROOF                         | 6         | STEP AND STAIR                |
| 7  | ROUND                              | 8         | WALL                          |
| 9  | DRIVER BUILT-IN PROFILE            | 10        | TRIMLESS-ARCHITECTURAL        |
| 11 | SURFACE & SUSPENSION-ARCHITECTURAL | <b>12</b> | <b>RECESSED-ARCHITECTURAL</b> |
| 13 | PLASTER IN TRIMLESS                | 14        | BEND & CURVED                 |

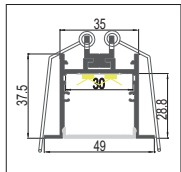

**LW-WN31**  
Page 168

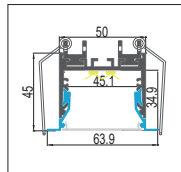

**LW-ER50**  
Page 170

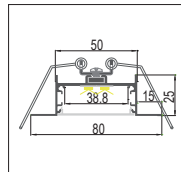

**LW-ER50-2**  
Page 174

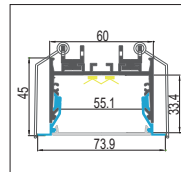

**LW-ER60**  
Page 172

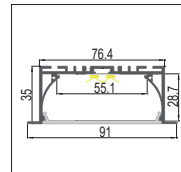

**LW-ER7635**  
Page 176

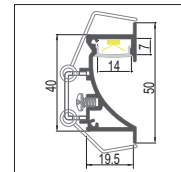

**LW-AW1-50**  
Page 178

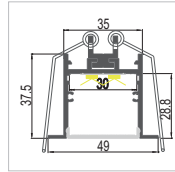

LW-WN31

60°



### Specification:

Suitable for PCB 30mm

Max. LED power: 38.4w/m

Installation: Recessed

Material: Extruded Aluminium 6063

Finish: Silver anodised, Black or White \*

Diffuser: PMMA flexible diffuser, can be 25m continuous rolled

Length: 2000mm or 2500mm continuous \*\*

Size: Profile (W) 49mm, (H) 37.5mm

Driver installation: Remote driver required

\* Custom powder coated colour upon request. Surcharge apply.

\*\* Profile sold per metre. Can be cut to suit any length up to 6000mm.

## Aluminium Profile



WN31

#### PMMA Diffuser

Code: WN31-O (Opal, light trans. >63%)

Code: WN31-N (New opal, light trans. >74%)

Code: WN31-F (Frost, light trans. >89%)

Code: WN31-C (Clear, light trans. >95%)



#### Black Diffuser

Code: WN31-B (Black, light trans. >22%)

MOQ: 200M





## Installing accessories:



**Aluminium Endcap** Code: WN31-Cap  
(with/without hole) Code: WN31-Cap-H



**Spring Clip**  
Code: SC-N31



(Optional)

**Joiners 180°A**  
Code: J-180A



(Optional)

**Joiners 90°A**  
Code: J-90A



(Optional)

**Joiners 120°A**  
Code: J-120A

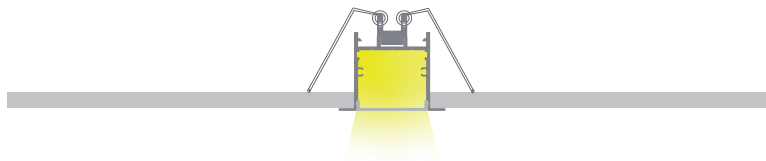

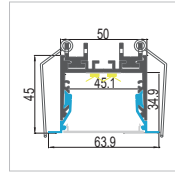

LW-ER50



### Specification:

Suitable for PCB	45mm
Max. LED power:	57.6w/m
Installation:	Recessed
Material:	Extruded Aluminium 6063
Finish:	Silver anodised, Black or White *
Diffuser:	PMMA flexible diffuser, can be 25m continuous rolled
Length:	2000mm or 2500mm continuous **
Size:	Profile (W) 63.9mm, (H) 45mm
Driver installation:	Remote driver required
* Custom powder coated colour upon request. Surcharge apply.	
** Profile sold per metre. Can be cut to suit any length up to 5000mm.	

## Aluminium Profile



ER50



#### PMMA Diffuser

Code: ER50-O (Opal, light trans. >60%)  
 Code: ER50-N (New opal, light trans. >74%)

## Installing accessories:



**Aluminium Endcap** Code: ER50-Cap  
(with/without hole) Code: ER50-Cap-H



**Spring Clip**  
Code: SC-ER50



(Optional)

**Joiners 90°A**  
Code: J-90A



(Optional)

**Joiners 180°A**  
Code: J-180A



(Optional)

**Joiners 120°A**  
Code: J-120A

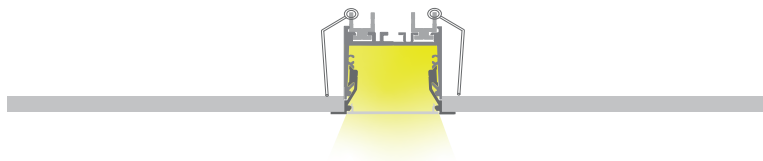

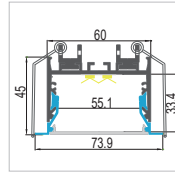

LW-ER60



### Specification:

Suitable for PCB	38mm
Max. LED power:	57.6w/m
Installation:	Recessed
Material:	Extruded Aluminium 6063
Finish:	Silver anodised, Black or White *
Diffuser:	PMMA flexible diffuser, can be 25m continuous rolled
Length:	2000mm or 2500mm continuous **
Size:	Profile (W) 73.9mm, (H) 45mm
Driver installation:	Remote driver required
* Custom powder coated colour upon request. Surcharge apply.	
** Profile sold per metre. Can be cut to suit any length up to 5000mm.	

## Aluminium Profile



ER60



### PMMA Diffuser

Code: ER60-N (New opal, light trans. >74%)

## Installing accessories:



**Aluminium Endcap** Code: ER60-Cap  
(with/without hole) Code: ER60-Cap-H



**Spring Clip**  
Code: SC-ER50



**Joiners 90°A**  
Code: J-90A



**Joiners 90°B**  
Code: J-90B



**Joiners 120°A**  
Code: J-120A



**Joiners 180°A**  
Code: J-180A



**Joiners 120°B**  
Code: J-120B

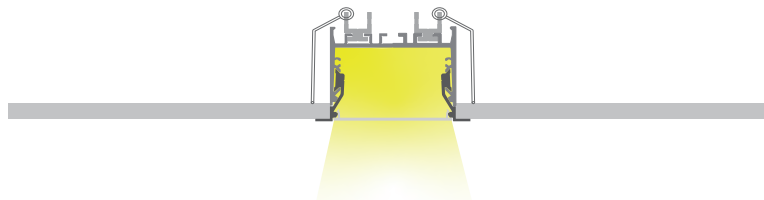

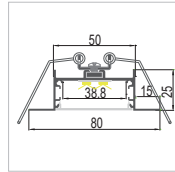

LW-ER50-2



### Specification:

Suitable for PCB	50mm
Max. LED power:	38.4w/m
Installation:	Recessed
Material:	Extruded Aluminium 6063
Finish:	Silver anodised, Black or White *
Diffuser:	PMMA flexible diffuser, can be 25m continuous rolled
Length:	2000mm or 2500mm continuous **
Size:	Profile (W) 80mm, (H) 25mm
Driver installation:	Remote driver required
* Custom powder coated colour upon request. Surcharge apply.	
** Profile sold per metre. Can be cut to suit any length up to 6000mm.	

## Aluminium Profile



ER50-2



### PMMA Diffuser

Code: ER50-2-O (Opal, light trans. >60%)  
 Code: ER50-2-N (New opal, light trans. >74%)

## Installing accessories:



**Aluminium Endcap** Code: ER50-2-Cap  
(with/without hole) Code: ER50-2-Cap-H



**Spring Clip**  
Code: SC-WN31



**Joiners 90°A**  
Code: J-90A



**Joiners 180°A**  
Code: J-180A



**Joiners 120°A**  
Code: J-120A

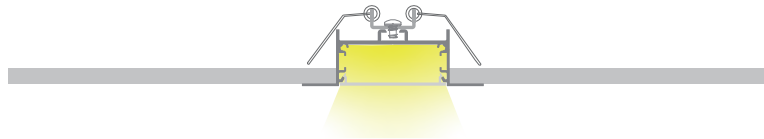

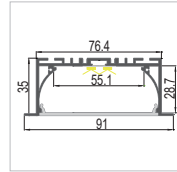

LW-ER7635



## Aluminium Profile



ER7635

### Specification:

Suitable for PCB 55mm

Max. LED power: 57.6w/m

Installation: Recessed

Material: Extruded Aluminium 6063

Finish: Silver anodised, Black or White \*

Diffuser: PC flexible diffuser

Length: 2000mm or 2500mm continuous \*\*

Size: Profile (W) 91mm, (H) 35mm

Driver installation: Remote driver required

\* Custom powder coated colour upon request. Surcharge apply.

\*\* Profile sold per metre. Can be cut to suit any length up to 6000mm.



#### PC Diffuser

Code: ER7635-O (Opal, light trans. >55%)



## Installing accessories:



**Aluminium Endcap** Code: ER7635-Cap  
(without hole)



**Spring Clip**  
Code: SC-ER7635

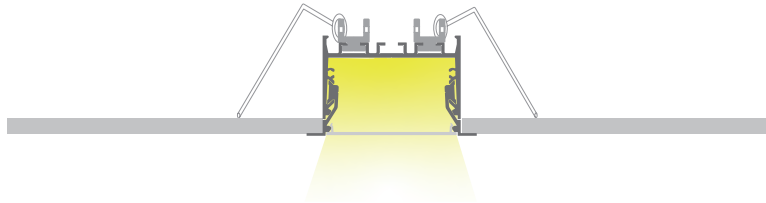

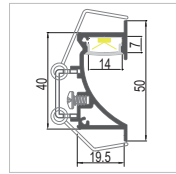

LW-AW1-50



**Specification:**

Suitable for PCB	14mm
Max. LED power:	19.2w/m
Installation:	Wall flush
Material:	Extruded Aluminium 6063
Finish:	Silver anodised, Black or White *
Diffuser:	PMMA flexible diffuser, can be 25m continuous rolled
Length:	2000mm or 2500mm continuous **
Size:	Profile (W) 19.5mm, (H) 50mm
Driver installation:	Remote driver required

\* Custom powder coated colour upon request. Surcharge apply.

\*\* Profile sold per metre. Can be cut to suit any length up to 6000mm.

**Aluminium Profile**



**AW1-50**



**PMMA Diffuser**

- Code: AW1-50-O (Opal, light trans. >52%)
- Code: AW1-50-M (Milky, light trans. >65%)
- Code: AW1-50-F (Frost, light trans. >81%)
- Code: AW1-50-C (Clear, light trans. >95%)

**PC Diffuser**

- Code: AW1-50-O (Opal, light trans. >52%)

## Installing accessories:



**Aluminium Endcap** Code: AW1-50-Cap  
(without hole)



**Spring Clip**  
Code: SC-N31-4

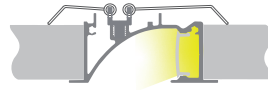

# Catalogue

- |           |                                    |    |                        |
|-----------|------------------------------------|----|------------------------|
| 1         | SURFACE                            | 2  | RECESSED               |
| 3         | CORNER                             | 4  | SURFACE & SUSPENSION   |
| 5         | WATERPROOF                         | 6  | STEP AND STAIR         |
| 7         | ROUND                              | 8  | WALL                   |
| 9         | DRIVER BUILT-IN PROFILE            | 10 | TRIMLESS-ARCHITECTURAL |
| 11        | SURFACE & SUSPENSION-ARCHITECTURAL | 12 | RECESSED-ARCHITECTURAL |
| <b>13</b> | <b><i>PLASTER IN TRIMLESS</i></b>  | 14 | BEND & CURVED          |

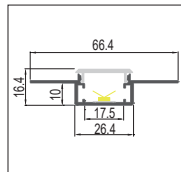

**LW-CT4N**  
Page 182

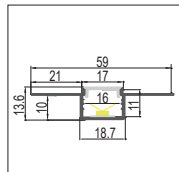

**LW-CT5**  
Page 184

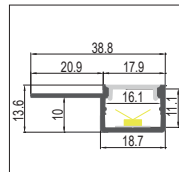

**LW-CT5S**  
Page 186

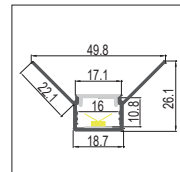

**LW-CT6**  
Page 188

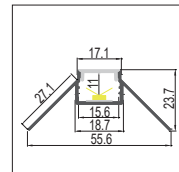

**LW-CT7**  
Page 190

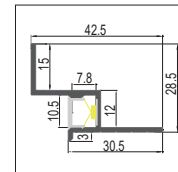

**LW-CT8**  
Page 192

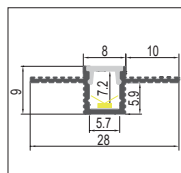

**LW-CT9**  
Page 194

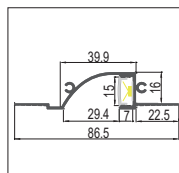

**LW-CTW1**  
Page 196

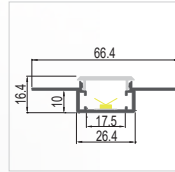
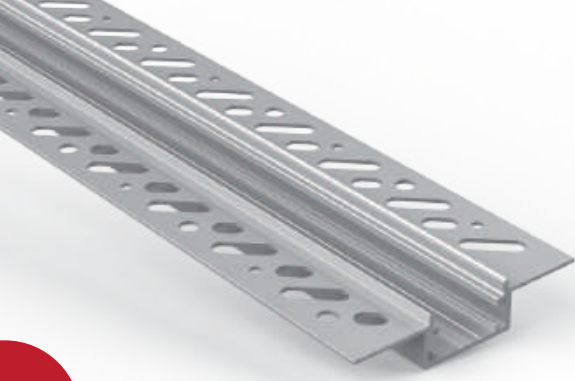

LW-CT4N



## Aluminium Profile

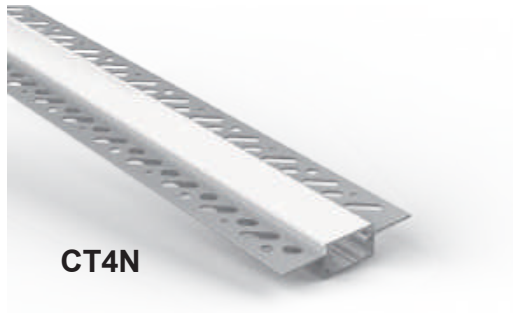

CT4N

### Specification:

Suitable for PCB	16mm
Max. LED power:	19.2w/m
Installation:	Plaster in Trimless
Material:	Extruded Aluminium 6063
Finish:	Silver anodised *
Diffuser:	PMMA flexible diffuser, can be 25m continuous rolled
Length:	2000mm or 2500mm continuous **
Size:	Profile (W) 66.4mm, (H) 16.4mm
Driver installation:	Remote driver required
* Custom powder coated colour upon request. Surcharge apply.	
** Profile sold per metre. Can be cut to suit any length up to 2500mm.	



#### PMMA Diffuser

Code: CT4N-O (Opal, light trans. >52%)

## Installing accessories:

	<b>Plastic Endcap</b> (with/without hole)	Code: CT4N-Cap Code: CT4N-Cap-H		<b>Joiners 90°B</b> Code: J-90B
	<b>Joiners 90°A</b> Code: J-90A			<b>Joiners 120°B</b> Code: J-120B
	<b>Joiners 120°A</b> Code: J-120A			<b>Joiners 180°A</b> Code: J-180A



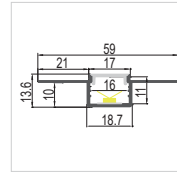
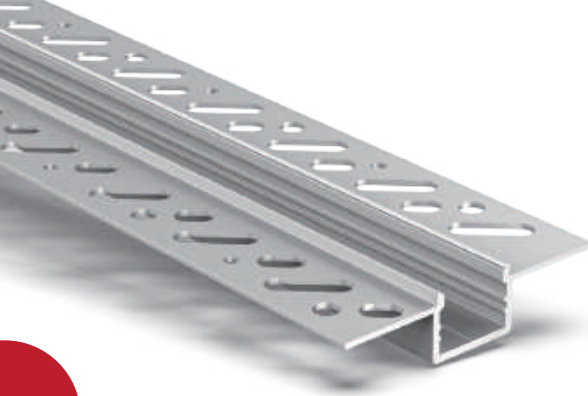

LW-CT5



**Specification:**

Suitable for PCB	16mm
Max. LED power:	19.2w/m
Installation:	Plaster in Trimless
Material:	Extruded Aluminium 6063
Finish:	Silver anodised *
Diffuser:	PMMA flexible diffuser, can be 25m continuous rolled
Length:	2000mm or 2500mm continuous **
Size:	Profile (W) 59mm, (H) 13.6mm
Driver installation:	Remote driver required
* Custom powder coated colour upon request. Surcharge apply.	
** Profile sold per metre. Can be cut to suit any length up to 2500mm.	

**Aluminium Profile**



**CT5**



**PMMA Diffuser**

Code: CT5-O (Opal, light trans. >52%)



**Black Diffuser**

Code:CT5-B (Black, light trans. > 22%)  
MOQ: 200M



## Installing accessories:



**Plastic Endcap** Code: CT5-Cap  
(with/without hole) Code: CT5-Cap-H



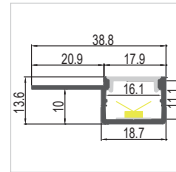

LW-CT5S



## Aluminium Profile



CT5S

### Specification:

Suitable for PCB	16mm
Max. LED power:	19.2w/m
Installation:	Plaster in Trimless
Material:	Extruded Aluminium 6063
Finish:	Silver anodised *
Diffuser:	PMMA flexible diffuser, can be 25m continuous rolled
Length:	2000mm or 2500mm continuous **
Size:	Profile (W) 38.8mm, (H) 13.6mm
Driver installation:	Remote driver required
* Custom powder coated colour upon request. Surcharge apply.	
** Profile sold per metre. Can be cut to suit any length up to 2500mm.	



#### PMMA Diffuser

Code: CT5S-O (Opal, light trans. > 52%)

## Installing accessories:



**Plastic Endcap** Code: CT5-Cap  
(with/without hole) Code: CT5-Cap-H



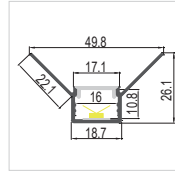
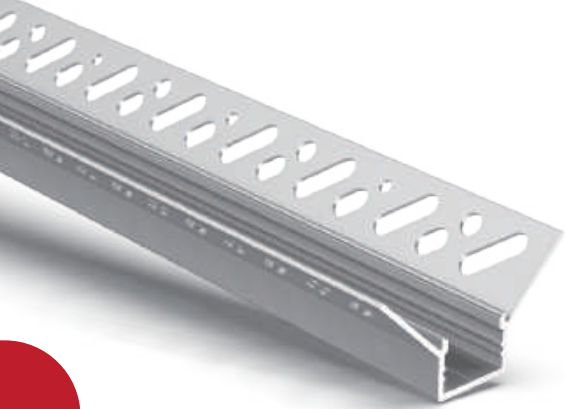

LW-CT6



**Specification:**

Suitable for PCB	16mm
Max. LED power:	19.2w/m
Installation:	Plaster in Trimless, Inside corner
Material:	Extruded Aluminium 6063
Finish:	Silver anodised *
Diffuser:	PMMA flexible diffuser, can be 25m continuous rolled
Length:	2000mm or 2500mm continuous **
Size:	Profile (W) 49.8mm, (H) 26.1mm
Driver installation:	Remote driver required
* Custom powder coated colour upon request. Surcharge apply.	
** Profile sold per metre. Can be cut to suit any length up to 2500mm.	

**Aluminium Profile**



CT6



**PMMA Diffuser**

Code: CT6-O (Opal, light trans. >52%)



**Black Diffuser**

Code:CT5-B (Black, light trans. > 22%)  
MOQ: 200M

PLASTER IN TRIMLESS

## Installing accessories:



Plastic Endcap Code: CT5-Cap  
(with/without hole) Code: CT5-Cap-H

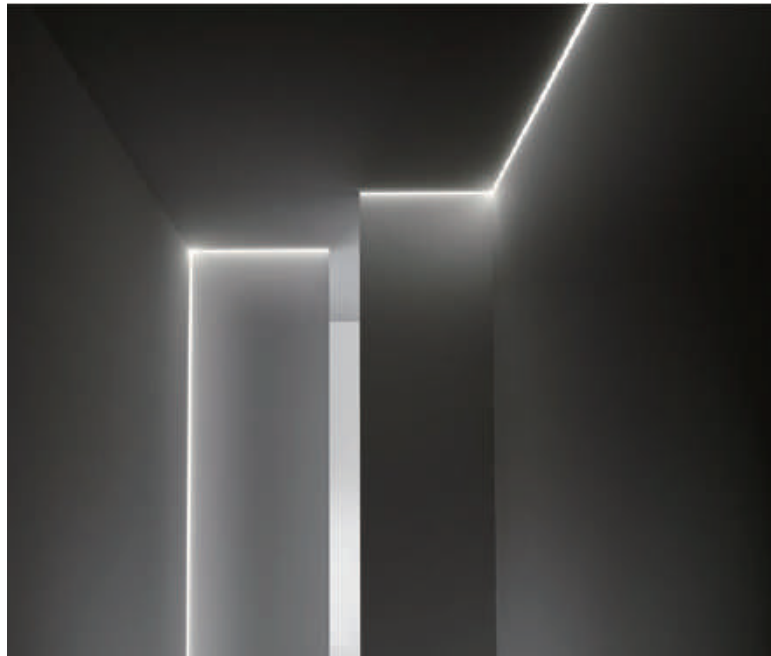
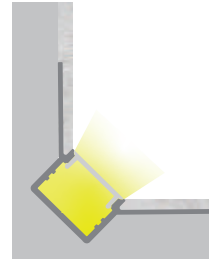
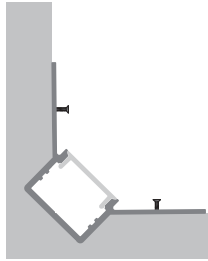

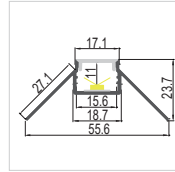

LW-CT7



## Aluminium Profile



CT7

### Specification:

Suitable for PCB 16mm

Max. LED power: 19.2w/m

Installation: Plaster in Trimless, Dutside corner

Material: Extruded Aluminium 6063

Finish: Silver anodised \*

Diffuser: PMMA flexible diffuser, can be 25m continuous rolled

Length: 2000mm or 2500mm continuous \*\*

Size: Profile (W) 56.6mm, (H) 23.7mm

Driver installation: Remote driver required

\* Custom powder coated colour upon request. Surcharge apply.

\*\* Profile sold per metre. Can be cut to suit any length up to 2500mm.



#### PMMA Diffuser

Code: CT7-O (Opal, light trans. >52%)



#### Black Diffuser

Code:CT5-B (Black, light trans. > 22%)

MOQ: 200M

## Installing accessories:



**Plastic Endcap** Code: CT5-Cap  
(with/without hole) Code: CT5-Cap-H

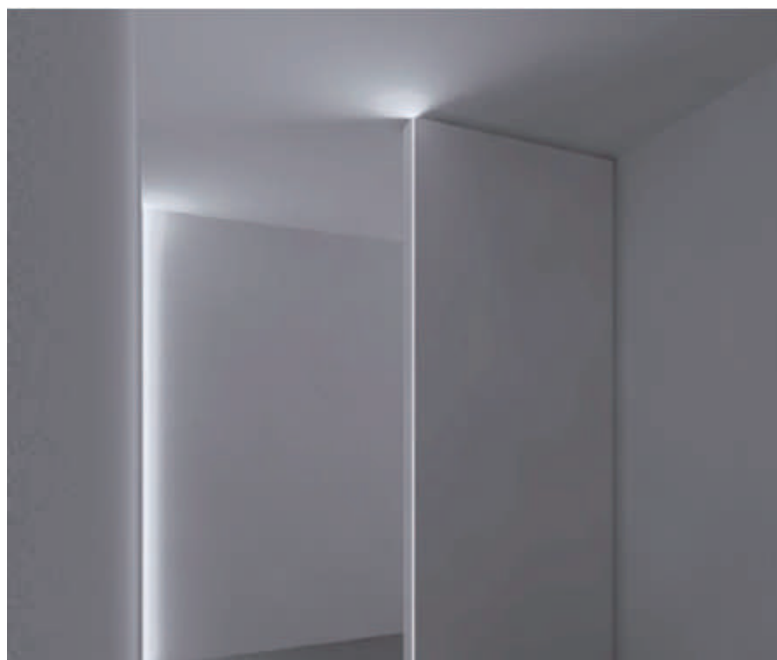
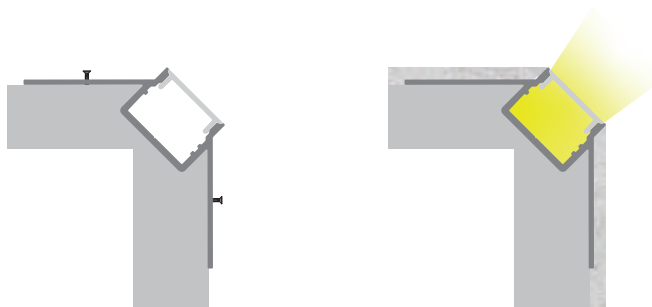

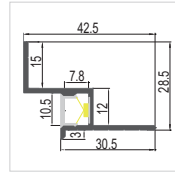

LW-CT8



## Aluminium Profile



CT8

### Specification:

Suitable for PCB 10mm

Max. LED power: 19.2w/m

Installation: Plaster in Trimless

Material: Extruded Aluminium 6063

Finish: Silver anodised \*

Diffuser: PMMA flexible diffuser, can be 25m continuous rolled

Length: 2000mm or 2500mm continuous \*\*

Size: Profile (W) 42.5mm, (H) 28.5mm

Driver installation: Remote driver required

\* Custom powder coated colour upon request. Surcharge apply.

\*\* Profile sold per metre. Can be cut to suit any length up to 2500mm.



#### PMMA Diffuser

Code: CT8-O (Opal, light trans. >52%)



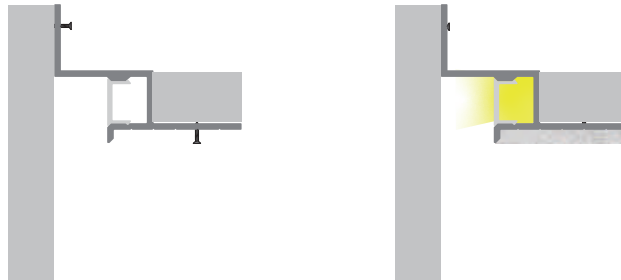

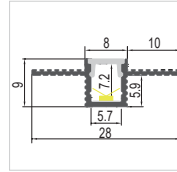

LW-CT9



## Aluminium Profile

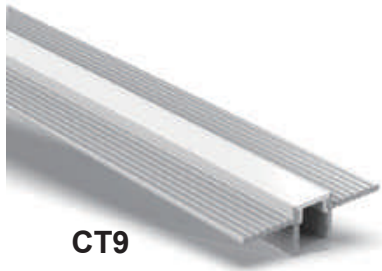

CT9

### Specification:

Suitable for PCB	5mm
Max. LED power:	9.6w/m
Installation:	Plaster in Trimless
Material:	Extruded Aluminium 6063
Finish:	Silver anodised *
Diffuser:	PC flexible diffuser
Length:	2000mm or 2500mm continuous **
Size:	Profile (W) 28mm, (H) 9mm
Driver installation:	Remote driver required
* Custom powder coated colour upon request. Surcharge apply.	
** Profile sold per metre. Can be cut to suit any length up to 2500mm.	



#### PC Diffuser

Code: CT9-O (Opal, light trans. >50%)  
Code: CT9-C (Clear, light trans. >94%)

## Installing accessories:



Plastic Endcap Code: AS9-Cap  
(with/without hole) Code: AS9-Cap-H

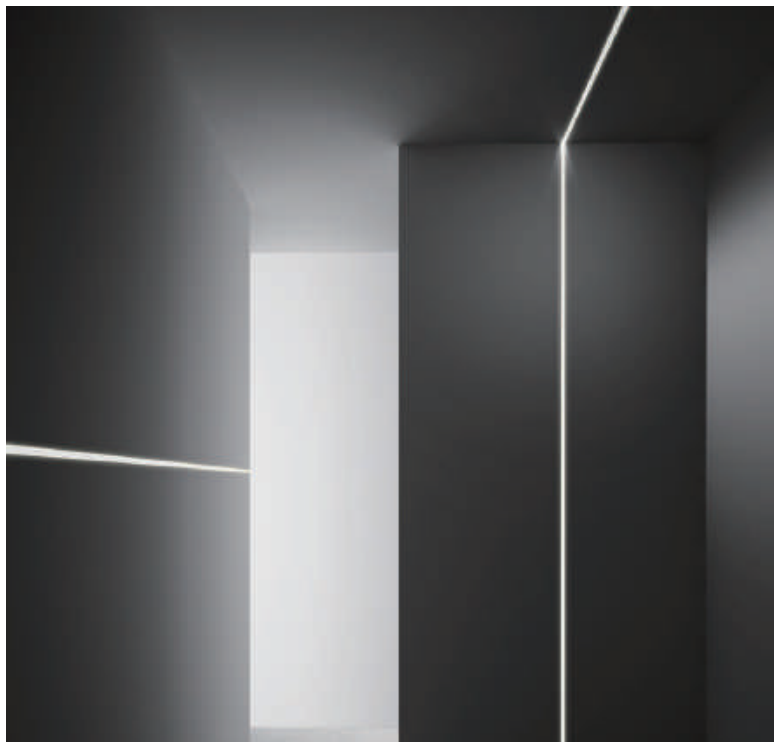
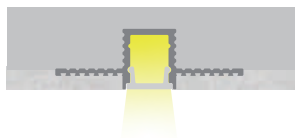

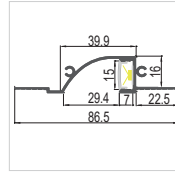
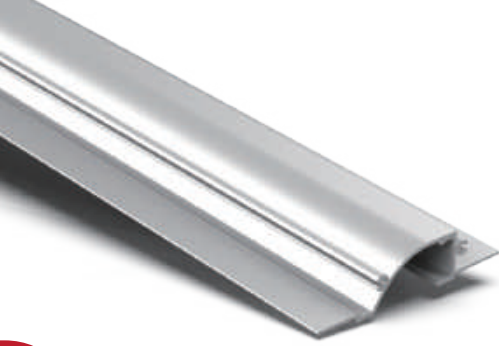

LW-CTW1



## Aluminium Profile

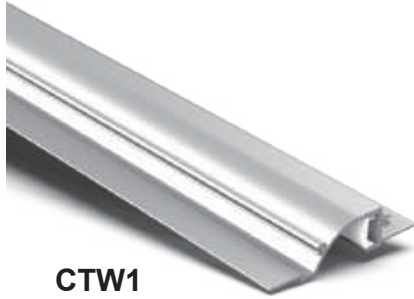

CTW1

### Specification:

Suitable for PCB	15mm
Max. LED power:	14.4w/m
Installation:	Wall/Ceiling recessed
Material:	Extruded Aluminium 6063
Finish:	Silver anodised, white coated *
Diffuser:	PMMA flexible diffuser, can be 25m continuous rolled
Length:	2000mm or 2500mm continuous **
Size:	Profile (W) 86.6mm, (H) 16mm
Driver installation:	Remote driver required
* Custom powder coated colour upon request. Surcharge apply.	
** Profile sold per metre. Can be cut to suit any length up to 6000mm.	



#### PMMA Diffuser

- Code: AW1-O (Opal, light trans. >52%)
- Code: AW1-M (Milky, light trans. >65%)
- Code: AW1-F (Frost, light trans. >81%)
- Code: AW1-C (Clear, light trans. >95%)

#### PC Diffuser

- Code: AW1-O (Opal, light trans. >52%)

## Installing accessories:



Bolt  
Code: CTW1

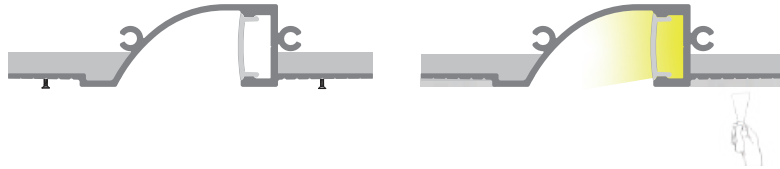

# Catalogue

- |    |                                    |           |                                 |
|----|------------------------------------|-----------|---------------------------------|
| 1  | SURFACE                            | 2         | RECESSED                        |
| 3  | CORNER                             | 4         | SURFACE & SUSPENSION            |
| 5  | WATERPROOF                         | 6         | STEP AND STAIR                  |
| 7  | ROUND                              | 8         | WALL                            |
| 9  | DRIVER BUILT-IN PROFILE            | 10        | TRIMLESS-ARCHITECTURAL          |
| 11 | SURFACE & SUSPENSION-ARCHITECTURAL | 12        | RECESSED-ARCHITECTURAL          |
| 13 | PLASTER IN TRIMLESS                | <b>14</b> | <b><i>BEND &amp; CURVED</i></b> |

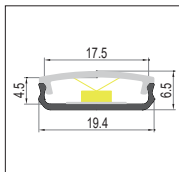

LW-B1  
Page 200

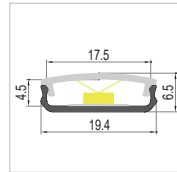

LW-B1



**Specification:**

Suitable for PCB	15mm
Max. LED power:	14.4w/m
Installation:	Surface
Material:	Extruded Aluminium 6063
Finish:	Silver anodised, Black or White *
Diffuser:	PMMA flexible diffuser, can be 25m continuous rolled
Length:	2000mm or 2500mm continuous **
Size:	Profile (W) 19.4mm, (H) 6.5mm
Driver installation:	Remote driver required

\* Custom powder coated colour upon request. Surcharge apply.  
 \*\* Profile sold per metre. Can be cut to suit any length up to 3000mm.

**Aluminium Profile**

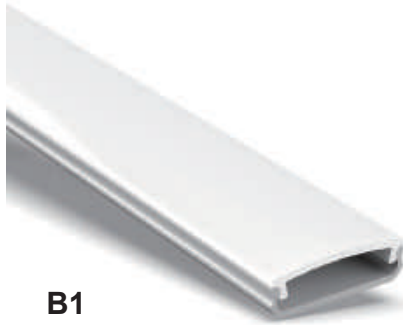

B1



**Bending tool**



**PMMA Diffuser**

Code: B1-O (Opal, light trans. >68%)  
 Code: B1-F (Frost, light trans. >83%)

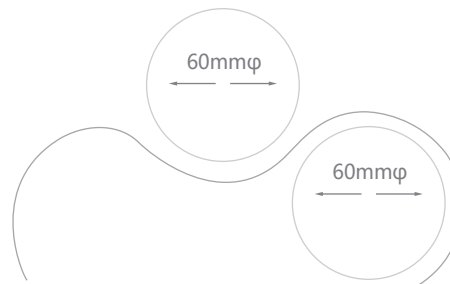

BEND & CURVED SERIES



## Installing accessories:



**Aluminium Endcap** Code: B1-Cap  
(with/without hole) Code: B1-Cap-H



**Metal Clip**  
Code: AT11-Clip-M

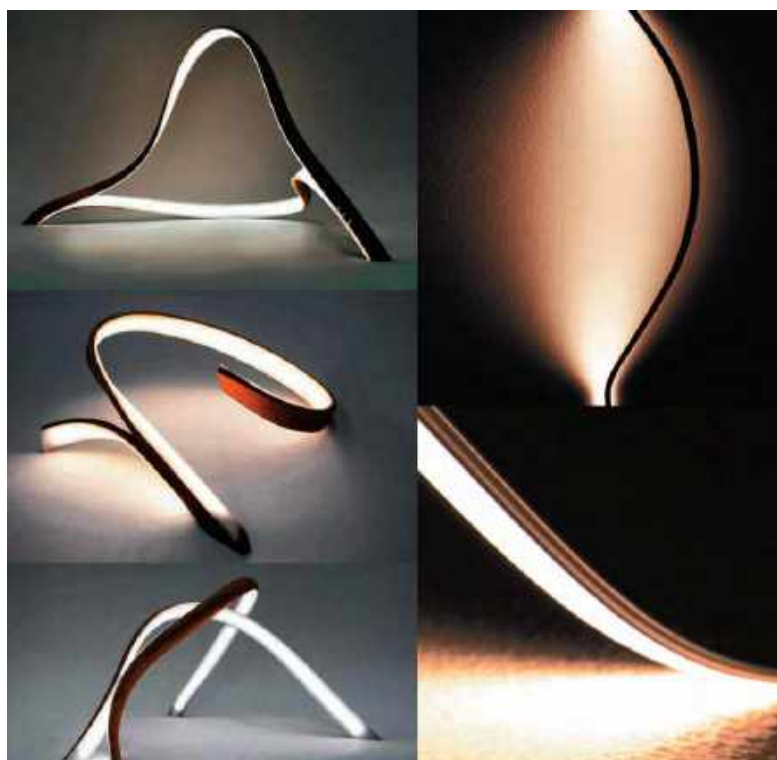
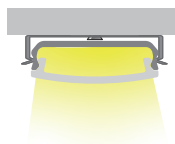



Product Code: LW-DK02  
Product Name: Buttin dimmer switch



Product Code: LW-PIR001  
Product Name: PIR sensor switch



Product Code: LW-TD002  
Product Name: Proximity sensor switch



Product Code: LW-FM  
Product Name: Wire connector 1 female to multi Plug



Product Code: LW-A12  
Product Name: 2 Pin connector male female JST plug cable



Product Code: LW-A13  
Product Name: 2 3 4 5 Pin waterproof M12 IP65 cable wire plug



Product Code: LW-A14  
Product Name: 2 3 4Pin wire waterproof connector plug IP67



Product Code: LW-A15  
Production Name: Male to Female Connector Waterproof IP68

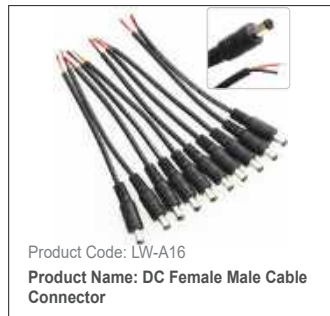

Product Code: LW-A16  
Product Name: DC Female Male Cable Connector

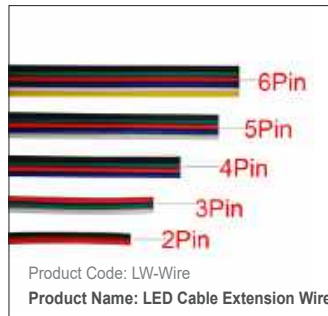

Product Code: LW-Wire  
Product Name: LED Cable Extension Wire



Product Code: LW-A12-M  
Product Name: Male to Female Plug Connector With Wire Cables



Product Code: LW-A1  
Product Name: DC Power Adapter Connector Plug



Product Code: LW-A18  
Product Name: LED Strip fast Connector

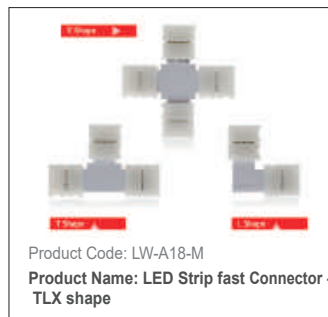

Product Code: LW-A18-M  
Product Name: LED Strip fast Connector - TLX shape



Product Code: LW-3M tape  
Product Name: 3M Adhesive Tape



Product Code: LW-MT  
Product Name: Plating Tape/Masking Tape



Product Code: LW-RF  
**Product Name: 18A RF Wireless Touch RGB controller**



Product Code: LW-DD  
**Product Name: Dimmer Adjustable Brightness Controller**



Product Code: LW-TD  
**Product Name: Touch LED Dimmer Controller**



Product Code: LW-MC  
**Product Name: Mini Controller Light Strip Controller**



Product Code: LW-DIM  
**Product Name: DIM Brightness Dimming For Single Color LED Strip**



Product Code: LW-CCT  
**Product Name: CCT Brightness Dimming For Dual White LED Strip**



Product Code: LW-C-RGB  
**Product Name: RGB Brightness Dimming For RGB LED strip 3 Color**



Product Code: LW-C-RGBW  
**Product Name: Brightness Dimming & RGB+W/WW Color Changing**



Product Code: LW-D4  
**Product Name: Decoder LED Controller 4 Channel Driver**



Product Code: LW-SC-DCV  
**Product Name: DALI&PUSH DIM CV 10-360W Dimmable LED driver**  
 Output Power: 10-360W



Product Code: LW-SC-DCC  
**Product Name: DALI CC 10W-200W Dimmable LED driver**  
 Output Power:10-200W



Product Code: LW-SC-10CV  
**Product name: 0/1-10V CV 10-360W Dimmable LED driver**  
 Output Power: 10-360W



Product Code: LW-SC-10CC  
**Product Name:0-10V.1-10V CC 10-200W Dimmable LED driver**  
 Output Power: 10-200W



Product Code: LW-SC-TCV1  
**Product Name: TRIAC CV 100-277V Dimmable LED driver**  
 Output Power:30-300W



Product Code: LW-SC-TCV2  
**Product Name: TRIAC CV 200-240V Dimmable LED driver**  
 Output Power:30-360W



Product Code: LW-HLD  
**Product Name: HuaLiang LED drivers**  
 Output Power:12-300W



Product Code: LW-MW-HLG

**Product Name: Meanwell HLG series LED Driver**

Output Power: 40/60/80/100/120/150/185/240/320/480/600W



Product Code: LW-MW-APV

**Product Name: Meanwell APV series LED Driver**

Output Power: 8/12/16/25/35W



Product Code: LW-MW-ELG

**Product Name: Meanwell ELG series**

Output Power: 75/100/150/200/240W



Product Code: LW-MW-LPV

**Product Name: Meanwell LPV series**

Output Power: 20/35/60/100/150W



Product Code: LW-MW-LPF

**Product Name: Meanwell LPF series**

Output Power: 16/25/40/60/90W

## Ledwide Product Applications from our customers

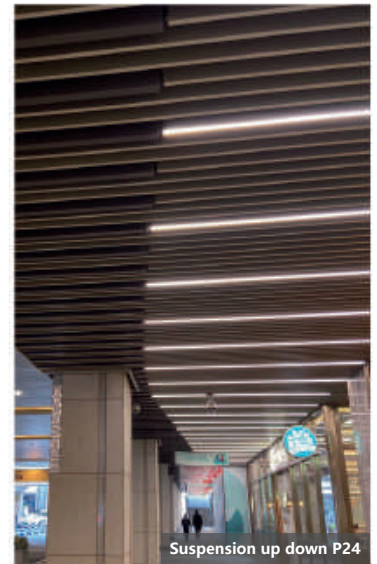
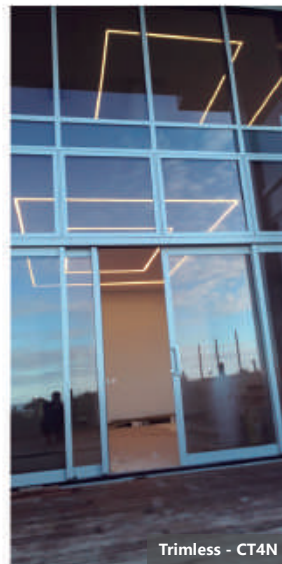
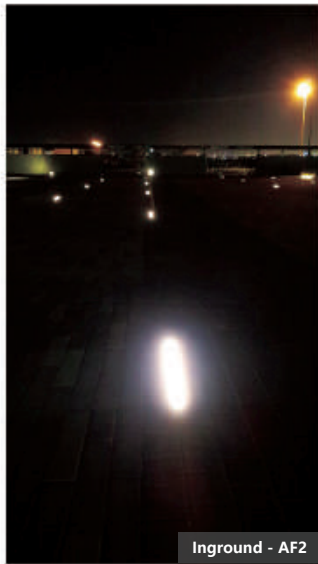
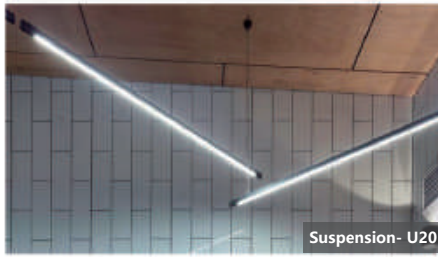
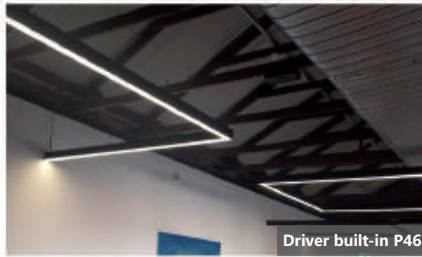
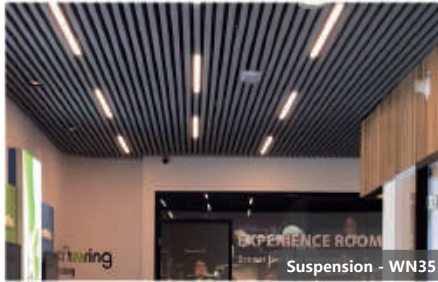
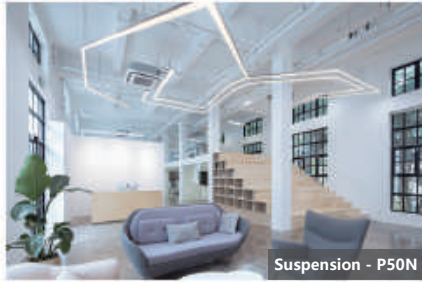



## **CONTACT US**

**ADDRESS :** 1-2/F, Building A2, Sinopol Ind. Park,  
BaiHua Communities, Guangming  
District, Shenzhen, P.R. China

**POSTCODE :** 518107

**PHONE :** 0086 755 29362351

**FAX :** 0086 755 29014058

**EMAIL :** [info@ledwide.com](mailto:info@ledwide.com)

**WEBSITE :** [www.ledwide.com](http://www.ledwide.com)