



Profibus DP Pressure Transmitter

User Manuel



Microcyber Inc



FIELD COMM GROUP™
*Connecting the World of
Process Automation*



HART™
COMMUNICATION PROTOCOL



CERTIFICATE OF MEMBERSHIP

The Board of Directors hereby acknowledges that

Microcyber Corporation

has accepted and fulfilled the requirements of the Bylaws
and all rights and privileges of membership are hereby granted

Membership Term: November 2019 – October 2020

President and CEO



Content

Chapter 1	Introduction.....	4
Chapter 2	Installation.....	7
2.1	Transmitter Installation.....	7
2.2	Inlet Pressure Pipe Installations.....	7
2.3	Wiring.....	8
2.4	DIP Switch Configuration.....	10
Chapter 3	Working Principle and Structure.....	11
3.1	Working Principle Brief Introduction.....	12
3.2	Product Structure Description.....	13
Chapter 4	Adjusting in Workplace.....	15
4.1	Magnetic Bar Operation Introduction.....	15
4.2	Adjusting for DP Smart Pressure Transmitter.....	17
4.3	Return Instrument Data to Factory Data.....	27
Chapter 5	Configuration.....	28
5.1	Function Block.....	28
5.2	Parameter Attribute Table.....	28
5.3	Function Configuration.....	35
Chapter 6	Technical Specification.....	38
Appendix 1	Smart Pressure Transmitter Selection.....	39



Company Introduction

Microcyber Inc. established as a high-tech enterprise by the Shenyang Institute of Automation Chinese Academy of Sciences, mainly engages in advanced industrial control systems, equipments, instruments and chips for industrial process automation control solutions in the research, development, production and application. Microcyber undertakes a number of national scientific and technical key task and “863” project, and has Liaoning Province networked control systems engineering research center. The company successfully developed the FF H1 fieldbus protocol stack which is number one to be approved internationally in China, and the Industrial Ethernet Protocol(HSE) which is number one to be approved in China, and the domestic first fieldbus instrument which has a function of national-level intrinsically safe explosion--proof and safety barrier. Also Microcyber participated in the drafting of the domestic first Ethernet-based industrial automation protocol standards (Ethernet for Plant Automation, EPA). As a result, serial products are composed of configuration, control software, embedded software, control system, instrument chip to the OEM board, and make Microcyber be an industrial automation products provider in full range, and also further Microcyber’s leading position in the field of fieldbus technology.

Microcyber is the FF member, the HART member and the Profibus National Organization (PNO) member.



Microcyber passes the Authentication of ISO 9001 Quality System, and has an outstanding innovative R&D team, plentiful practical experiences of design of the Automatic engineering, a leading product series, a huge market network, a strict quality management system and an excellent enterprise culture. All these further a solid foundation of entrepreneurship and sustainable development for Microcyber.

Microcyber Inc. is looking forward to the long-term smooth and close cooperation with you.



Chapter 1 Introduction

NCS-PT105 II S Profibus DP pressure transmitter with advanced, mature, reliable piezoresistive silicon pressure sensor has been designed meticulously by combining advanced microprocessor technology and digital capacitance measurement technology. The powerful functions and high-speed computing capability of the microprocessor make it have excellent qualifications such as smart, high accuracy, high reliability, stable zero, etc. The LCD module can display physical parameters (e.g. pressure, temperature, etc). It can realize the functions such as zero adjustment, range setting by key-press operation, and it is easy for field testing.

NCS-PT105 II S Profibus DP pressure transmitter can measure pressure, differential pressure, liquid level, flow, and other industrial parameters. It can be widely used in the petroleum, chemical, electricity, and metallurgical industries, etc.

According to measured pressure types, NCS-PT105 II S Profibus DP pressure transmitter can be divided into two types:

Model	Pressure type
NCS-PT105 II SP SG	Gauge pressure transmitter
NCS-PT105 II SP SA	Abolute pressure transmitter

● Dimensions

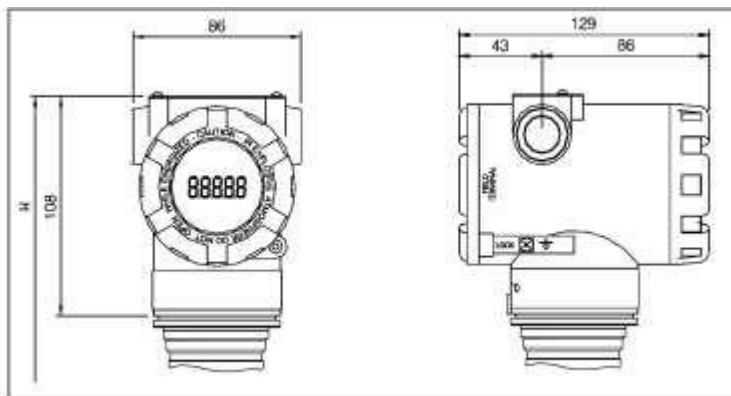

Figure 1.1 Dimensions (Unit: mm)

● Structure

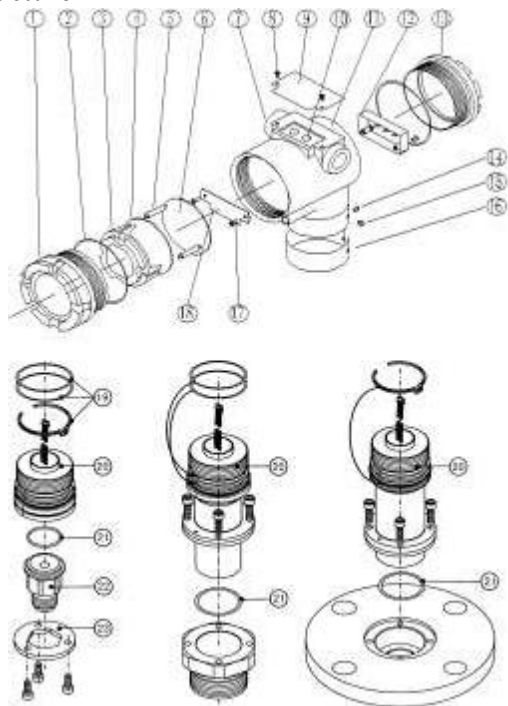

Figure 1.2 Structures

1	Front cover	2	O ring	3	Display board housing	4	LCD board
5	Position column	6	Communication board	7	Wire hole	8	Nameplate screw
9	Nameplate	10	Z/S hole	11	Electric housing	12	Terminal board
13	Rear cover	14	Lock screw	15	Tag screw	16	Tag
17	Screw	18	Terminal board	19	O ring	20	Sensor



21	O ring	22	Adapter	23	Flange		
----	--------	----	---------	----	--------	--	--

Chapter 2 Installation

The measurement accuracy of the smart transmitter depends mainly on the correct installation of the smart pressure transmitter and the pressure inlet tube. In particular, the flow measurement mainly relates to the correct installation of measurement device.

2.1 Transmitter Installation

The smart pressure transmitter can be installed onto 2 inch pipeline, or installed directly to the wall or instrument board.

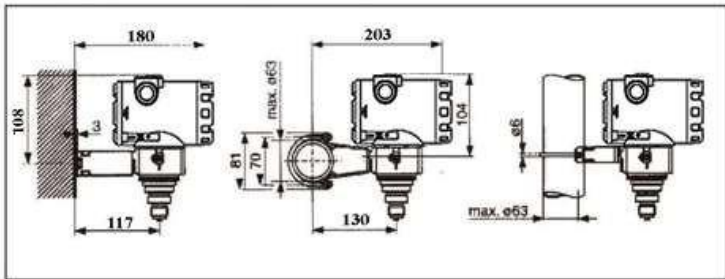

Figure 2.1 Pressure Transmitter Installations

2.2 Inlet Pressure Pipe Installations

The correct installation of pipeline depends on the measurement medium. Smart transmitter can measure liquid, steam or other gases. The pressure port, smart transmitter and related position of flow pipe are different according to different measurement medium.

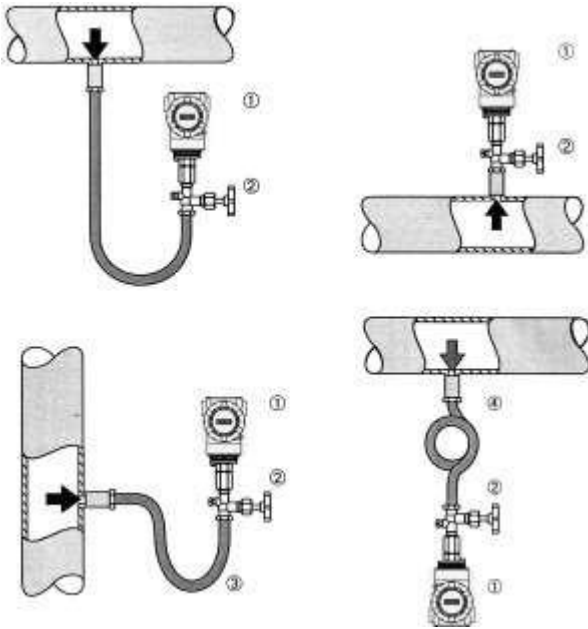

Figure 2.2 Inlet Pressure Pipe Installations

1	Transmitter	2	Inlet pressure valve
3	Inlet pressure pipe	4	Pipeling

2.3 Wiring

The power and signal of smart transmitter are sharing one pair of cables (Bus cable). The specific Fieldbus cable IEC61158-2 is recommended. The terminal is at the rear cover, the terminal wiring board could be seen after screwing the rear cover (marked as “FIELD TERMINAL”).

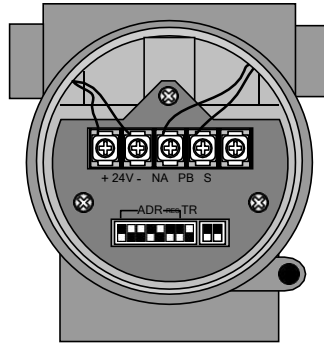
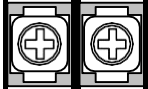



Figure 2.3 Wiring

 <p>+ 24V -</p>	<p>Provide stable 24VDC.</p>
 <p>NA PB S</p>	<p>Provide bus signal. NA: - PB: + S: Cable screen</p>

The bus cable of smart transmitter should not share the line pipe or trunkings with other device, and should be away from high-power device.

2.4 DIP Switch Configuration

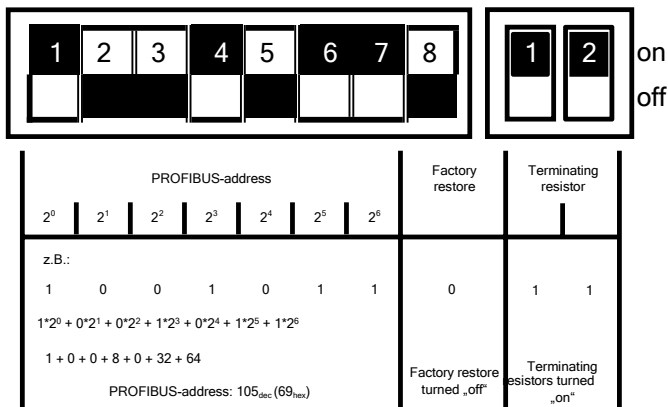

Figure 2.4 DIP Switch Configuration

When leaving the factory, all the DIP switches should be “off”.

Setting device address and returning to factory value affect when the device is power on again.

Chapter 3 Working Principle and Structure

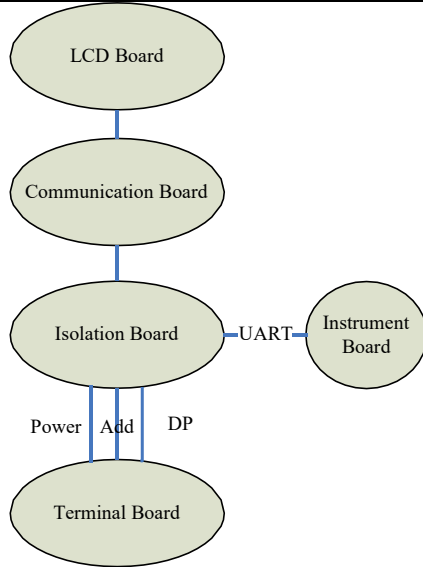

Figure 3.1 Profibus DP Pressure Transmitter Hardware Structures

Profibus DP pressure transmitter consists of five parts, and LCD board and instrument board selects present circuit board of pressure transmitter, no more descriptions in detail here.

The communication board consists of CPU, SRAM, VPC3+, EEPROM, etc. It is responsible for DP communication, data communication with instrument board, drive LCD display, running data algorithm, etc.

The isolation board main function includes power supply changeover, providing power supply separately to communication board, instrument



board, DP isolation drive, etc. The isolation communication controller is used to isolate communication and instrument board and DP drive communication controller, etc. It switches the DP address switch signal on terminal board to communication board. The reed switch is used for magnetic bar parameter setting.

3.1 Working Principle Brief Introduction

The smart pressure transmitter uses piezoresistive silicon pressure sensor. During the user's operation, the working pressure produces isolation diaphragm offset, and passes pressure to resistance bridge (semiconductor technology) through filling liquid, together with the bridge road output voltage change related to pressure, be measured and further processing.

Good advantages:

- 1) Process pressure can reach 700 bar
- 2) Better long-term stability
- 3) Guarantee over-voltage ability to four times of the normal pressure
- 4) The second chamber is used for improving mechanical strength, prevent media leakage caused by sensor damage

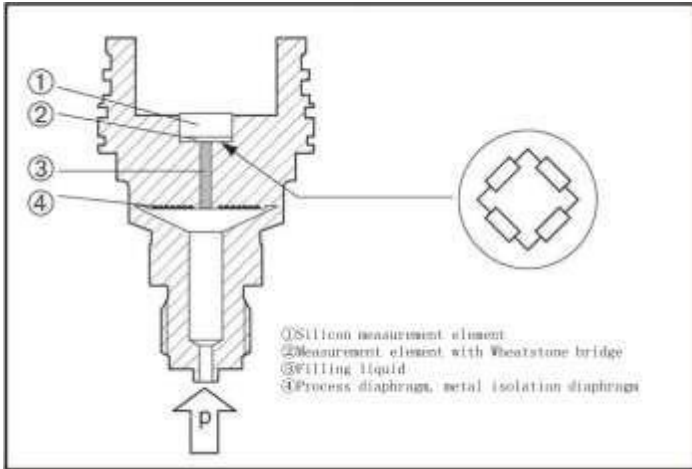

Figure 3.2 Piezoresistive Silicon Sensor Structure

The instrument board is responsible for real-time temperature acquisition and uploads it together with original AD value to communication board. The communication board is not only responsible for communication between smart pressure transmitter and protocol bus, also using data from instrument board to calculate differential pressure value according to calibration parameters, and pass it to upperstory device via respective protocol. The terminal board provides a simple signal interface to communication board.

3.2 Product Structure Description

Sensitive component encapsulates piezoresistive silicon measurement diaphragm capsule, and draws forth four bridge wirings. The bridge

wirings are welded separately to bridge diaphragm via process connection, which is a part of sensor.

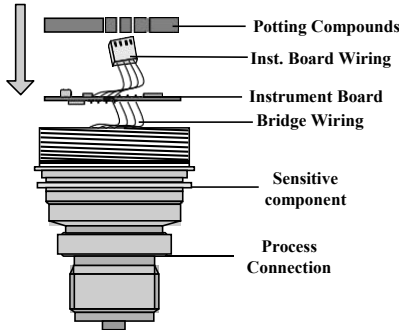

Figure 3.3 Sensor and Instrument Board

The instrument board is installed in the sensitive component of sensor, the bridge wiring of sensitive component is welded in the measurement part of instrument board. The potting compound in the role of isolation and heat conduction fixes the instrument board to the reserve cavity. The four-core instrument board wiring is reserved in the outside, used to connect communication board.

Chapter 4 Adjusting in Workplace

4.1 Magnetic Bar Operation Introduction

The adjusting in workplace can be carried out by inserting magnetic bars into the holes marked as “SPAN” or “ZERO”, shown as Figure 4.1.

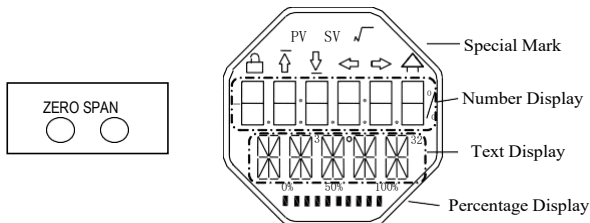

Figure 4.1 Magnetic Bar Inserting Location and LCD Display

The following will show how to utilize different combinations of magnetic bars inserting to simulate four virtual key buttons, which is convenient for description of adjusting in workplace. According to different functions, the four virtual key buttons are defined as Mode (M), Input adjusting ([↑], [↓]) and Confirmation ([Enter]).

- ✧ Mode (M): It can be switched in all operational modes.
- ✧ Input adjusting [↑]: Increase operation.
- ✧ Input adjusting [↓]: Decrease operation
- ✧ Confirmation [Enter]: Confirmation operation.

The detailed info for operations of (M), [↑], [↓] and [Enter] are shown as following:



Mode ⁽¹⁾	Input Adjusting ⁽¹⁾		Confirmation
[M]	[↓]	[↑]	[Enter]
Insert the magnetic sticks into “Zero” and “Span” at the same time ⁽²⁾	Zero	Span	Insert “Zero” and “Span” for 2s, get them out ⁽²⁾

Notes:

1) Insert/Get out the magnetic bars in Mode (M) and Input adjusting is considered as ([↑], [↓]) a button operation, also, inserting the magnetic bars for long can be considered as a long operation. In a button operation, it is suggested that user should insert the magnetic bars for 1s, and then get it out. Otherwise, the operation can't be tested. The long operation is carried out automatically every second.

2) In order to avoid the collision between Confirmation and Mode, when user is carrying out the confirmation operation, when the process is 100%, it means that the magnetic bars are inserted for 2s, and then get the two magnetic bars out to make sure the confirmation operation. When the process is 100%, the magnetic bars are not taken out within 3s, which means to carry out switch operation. When the process is not 100%, user shall get the magnetic bars out without operation.

4.1.1 General Adjusting Method

Following is the general adjusting method, please refer to specific description for detailed info.



In the measurement value display mode, press Mode [M] to do mode switch.

When it is displayed in mode needs to be adjusted, get out the two magnetic bars, the present value to be adjusted will be displayed in the LCD.

Press [↑] or [↓] to adjust, after that, press [Enter] to confirm.

Press [M], switch to measurement value display mode.

Notes:

1. It is not necessary to confirm some functions. After adjustment, it is saved at the same time.
2. If there is no button operation within 1 min (There is no magnetic bars inserted in the two holes), it will return to normal display mode.

4.2 Adjusting for DP Smart Pressure Transmitter

By adjusting in the workplace, you can regulate transmitter's bus address, display variable type, point position, zero point, unit, the upper limit and lower limit of the transmitter, etc. The specific functions and button operations are shown as following.



Function	Mode	Button Function			Function Display	Display, Description
	[M]	[↑]	[↓]	[Enter]		
Measurement value display						Display the measurement value selected in Mode 11
Failure display						Failure! When the transmitter is in failure, it will display the reason.
Electronic damping	05	Increase	Decrease		Fun05 DAMP	Time constant, and the unit is second. Setting range: 0.0 to 32.0
Measurement value display source	11	Select from various of possibilities			Fun11 DISP	Display the expected the measurement result
Physical unit	12	Select			Fun12 UNIT	Physical unit
Decimal Point	14	Modify			Fun14 DECP	Decimal Point in display area



Zero point of primary value	08	—	—	Implementation calibration	Fun08 ZERO	For gauge pressure transmitter, differential pressure transmitter, it evacuates. For absolute pressure transmitter , it vacuumizes. The measurement value is pressure unit.
-----------------------------	----	---	---	----------------------------	------------	---



Function	Mode	Button Function			Function Display	Display, Description
	[M]	[↑]	[↓]	[Enter]		
Lower limit of range	16	Pre-setting increase	Pre-setting decrease	Implementation	Fun16 LOWER	Setting the lower limit of characteristic curve
Upper limit of range	17	Pre-setting increase	Pre-setting decrease	Implementation	Fun17 UPPER	Setting the upper limit of characteristic curve
Lower limit of input range	18	Pre-setting increase	Pre-setting decrease	Implementation	Fun18 IN 0%	No-source setting lower limit of input range
Upper limit of input range	19	Pre-setting increase	Pre-setting decrease	Implementation	Fun19 IN 100%	No-source setting upper limit of input range
Lower limit of output range	20	Pre-setting increase	Pre-setting decrease	Implementation	Fun20 OUT 0%	No-source setting lower limit of output range
Upper limit of output range	21	Pre-setting increase	Pre-setting Decrease	Implementation	Fun20 OUT 100%	No-source setting upper limit of output range

Press [M] for long, it can be switched among the functions above, shown as Figure 4.2.

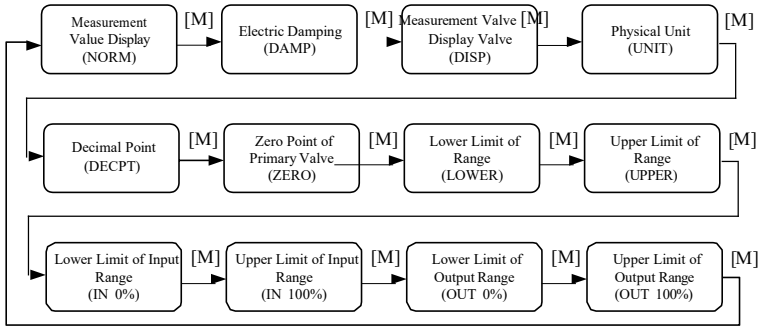

Figure 4.2 Adjustig Function Switch

4.2.1 Measurement Value Display

In the function of measurement value display, it will display the measurement value selected in Mode 11. The physical unit is set in Mode 12. The decimal point is set in Mode 14.

4.2.2 Error Display

The Error info appears in local operation, and after that, the error info will be shown for 10s.

4.2.3 Operation Steps for Setting Electronic Damping -- Mode 05

It is about setting time constant of electrical damping, the range is from 0 to 32s.

You shall set electrical damping according to the following steps:

--Set mode 05,



--Select damping via [↑] or [↓],

--Use [M] to do mode switch,

The damping only affects the output of analog input function block.

4.2.4 Operation Steps for Setting Measurement Value Display Source--

Mode 11

In this mode, you may select the value to be displayed. In SIMATIC PDM, it is the parameter of “Transmitter Type”.

You shall select the display source of measurement value according to the following steps:

--Set mode 11,

--Select the display source of measurement value via [↑] or [↓],

--Use [M] to do mode switch.

In Mode 12, the distributed physical unit depends on the display source of measurement value.

Following are the supportive measurement value display sources.

Measurement Value Display Source	LCD Auxiliary Info
[0]Primary value output of pressure transducer block	PRIM
[1]Second value output of pressure transducer block	SEC1
[2]AI function block output	AIOUT
[3]Sensor original value of pressure transducer block	SENS
[4]Sensor temperature value of pressure transducer block	TEMP

4.2.5 Operation Steps for Setting Physical Unit--Mode 12

The physical unit can be set by selecting in the list. The selected unit



depends on the display source of measurement value (Mode 11).

You shall set the physical unit according to the following steps:

--Set mode 12. When the mark of present value appears in the display area, the related text will be in the unit display area.

--Select a unit via [↑] or [↓],

--Use [M] to do mode switch.

Following is a list about physical unit can be used in every measurement type:

Pressure Unit List:

Code Code	Unit	Code	Unit	Code	Unit
1130	Pa	1140	atm	1150	mmH ₂ O(4°C)
1131	GPa	1141	psi	1151	mmH ₂ O(68°C)
1132	MPa	1142	psia	1152	ftH ₂ O
1133	KPa	1143	psig	1153	ftH ₂ O(4°C)
1134	mPa	1144	g/cm ²	1154	ftH ₂ O(68°C)
1135	μPa	1145	kg/cm ²	1155	inHg
1136	hPa	1146	inH ₂ O	1156	inHg(0°C)
1137	bar	1147	inH ₂ O(4°C)	1157	mmHg
1138	mbar	1148	inH ₂ O(68°C)	1158	mmHg(0°C)
1139	torr	1149	mmH ₂ O		

4.2.6 Operation Steps for Setting Decimal Point--Mode 14

The measurement value can display the accuracy of 5-bit decimal.

You shall move the decimal point position according to the following steps:

--Set mode 14. The present decimal point format will be displayed in measurement value display area.



--Select the expected display format via [↑] or [↓],



8.88888 88.8888 888.888 8888.88 88888.8 888888

--Use [M] to do mode switch.

4.2.7 Operation Steps for Zero Point of Primary Value -- Mode 15

When the transmitter is installed already and ready to operate, the outer effect such as installation location, surrounding temperature and allowable pressure related to installation (i.e. pressure column leading to pressure pipe of pressure transmitter) may cause the primary zero point to displace.

You shall calibrate zero point according to the following steps:

--Create a pressure scale,

--Set mode 15,

--Press [Enter] to set. If the setting is successful, it will show “OK”, otherwise it will show “Err”,

--The calibration is successful, it will return to display mode of measurement value.

0 will be in display area.

4.2.8 Operation Steps for Lower Limit of Range-- Mode 16

In this mode, you shall modify the slope of characteristic curve. The characteristic curve is rolling around the high setting point, which replaces the zero point calibration (Mode 08).

You shall implement the calibration of lower limit according to the



following steps:

- Select mode 16, LCD will display the calibrated process value last time and related unit,
- If you just would like to check the info, press [M] to do mode switch. Otherwise you may use the reference pressure,
- Input the reference pressure value starting from this point via [↑] or [↓],
- Press [Enter] to set. If the setting is successful, it will show “OK”, otherwise it will show “Err”,
- Use [M] to do mode switch.

4.2.9 Operation Steps for Upper Limit of Range-- Mode 17

In this mode, you shall modify the slope of characteristic curve. The characteristic curve is rolling around the low setting point.

You shall implement the calibration of upper limit according to the following steps:

- Select mode 17, LCD will display the calibrated process value last time and related unit,
- If you just would like to check the info, press [M] to do mode switch. Otherwise you may use the reference pressure,
- Input the reference pressure value starting from this point via [↑] or [↓],
- Press [Enter] to set. If the setting is successful, it will show “OK”, otherwise it will show “Err”,
- Use [M] to do mode switch.



4.2.10 Operation Steps for Lower Limit of Input Range-- Mode 18

In this mode, you shall set the lower limit of input range.

You shall do implement the calibration of lower limit of input range according to the following steps:

- Select mode 18, LCD will display the calibrated process value last time and related unit,
- Input the reference value starting from this point via [↑] or [↓],
- Press [Enter] to set. If the setting is successful, it will show “OK”, otherwise it will show “Err”,
- Use [M] to do mode switch.

4.2.11 Operation Steps for Upper Limit of Input Range-- Mode 19

In this mode, you shall set the upper limit of input range.

You shall do implement the calibration of upper limit of input range according to the following steps:

- Select mode 19, LCD will display the calibrated process value last time and related unit,
- Input the reference value starting from this point via [↑] or [↓],
- Press [Enter] to set. If the setting is successful, it will show “OK”, otherwise it will show “Err”,
- Use [M] to do mode switch



4.2.12 Operation Steps for Lower Limit of Output Range-- Mode 20

In this mode, you shall set the lower limit of output range.

You shall do implement the calibration of lower limit of range according to the following steps:

- Select mode 20, LCD will display the calibrated process value last time and related unit,
- Input the reference value starting from this point via [↑] or [↓],
- Press [Enter] to set. If the setting is successful, it will show “OK”, otherwise it will show “Err”,
- Use [M] to do mode switch.

4.2.13 Operation Steps for Upper Limit of Output Range-- Mode 21

In this mode, you shall set the upper limit of output range.

You shall do implement the calibration of upper limit of range according to the following steps:

- Select mode 21, LCD will display the calibrated process value last time and related unit,
- Input the reference value starting from this point via [↑] or [↓],
- Press [Enter] to set. If the setting is successful, it will show “OK”, otherwise it will show “Err”,
- Use [M] to do mode switch.



4.3 Return Instrument Data to Factory Data

Returning instrument data to factory data is a special operation, there is no function code. After the operation, all the configured data will disappear and will return to factory data. Please pay more attention when you do like this.

You may return instrument data to factory data according to the following steps:

- Turn off the power supply with instrument,
- Insert two magnetic bars into “Zero” and “Span” holes at the same time,
- Turn on the power supply for instrument, the LCD will display “RST?”,
- If you would like to return instrument data to factory data, get the two magnetic bars out, and then insert two magnetic bars, when the process is 100%, get the two magnetic bars out again, the LCD will display “R_OK”, which means the return is successful.
- If you wouldn't like to return instrument data to factory data, get the two magnetic bars out, and wait for 5 seconds, it will back to normal.

Notes:

If DIP switch is “on” when returning to factory data, it will return to factory data without “RST?”.

When the process is not 100%, if you get the two magnetic bars out, it may cancel the operation of returning instrument data to factory data.



Chapter 5 Configuration

5.1 Function Block

DP Transmitter realizes the PA standard function block, as the table shown below. Please refer to PROFIBUS PA specification for function block configuration methods.

Function Block Name	Description
Physical Block	Physical block (PB) describes the information of device specific hardware info, recognition info and diagnose info including device bit number, software version, hardware version, installation date, etc.
Transducer Block	Transducer block separates the function block from instrument input/output characteristic. It carries out the function of input/output data calibration and linearization, etc, and transfers the data to AI function block via inner channel.
Analog Input Block	Analog input block achieves analog process value via inner channel and process the value, and then provides the right measurement value to master device via bus communication.

5.2 Parameter Attribute Table

Characteristics of the block parameters are specified by the parameter attribute table. This table provides the following information.

Relative Index

Index offset of the parameter relative to the first parameter of the block.

Parameter Name

The Mnemonic name of the parameter

Object Type

Object type for the parameter value



Simple Simple variable



Record Structure of different simple variables

Array Array of simple variables

Data Type

Data type for the parameter value

Name Basic data type of Simple variable or array

DS-n Data structure (Record) number n

Store

Class of memory required

N Non-volatile parameter which shall be remembered through a power cycle but which is not under the static update code

S Static; Non-volatile and changing the parameter increases the static revision counter ST_REV

D Dynamic; the value is calculated by the block or read from another block.

Cst Constant. The parameter does not change in a device.

Size

Data size in number of octets (bytes).

Access

r Indicates that the parameter can be read

w Indicates that the parameter can be written

NOTE It is a valid behavior of the device that the range of writeable parameters is limited to the parameter value that is currently stored.

Parameter Usage



C Contained



I Input

O Output

Kind of Transport (minimum requirements as indicated)

a acyclic

cyc cyclic

Reset Class

The `FACTORY_RESET` (Physical Block parameter) affects a different set of parameters of the blocks in the device. The reset class characteristic of parameters determines if a parameter is involved in the signal chain of the measurement or actuation channel (functional parameter) or the parameter contains additional information (informational parameter).

F Functional

I Informational - Not applicable

Default Value

The value assigned to parameter in the initialization process. This is required for initialization of a not configured block. Values are of the data type of the parameter. If there is a value in the attribute table of a block, this value has to be used as default value (profile default value). If there is no value for a parameter in the attribute table, the default value is manufacturer specific (manufacturer default value).

Download Order

There are data consistency constraints in a device (e.g. several parameters using the same engineering unit). Changing one parameter may lead to



some calculation within a device.

Therefore a fixed download order of parameters into the device avoids data inconsistencies. A download is a sequence of write accesses to the set of parameters. This attribute defines the order the write access shall be done.

NOTE Of course each parameter can be written separately.

Mandatory / Optional

M Indicates the parameter is mandatory for acyclic access. Cyclic access may be configured separately.

O Indicates the parameter is optional.

5.2.1 Parameter Attributes of the Standard Parameters

Relative Index	Parameter Name	Object Type	Data Type	Store	Size	Access	Parameter Usage / Kind of Transport	Reset Class	Default Value	Mandatory Optional (Class A/B)
0	BLOCK_OBJECT	Record	DS-32	Cst	20	r	C/a	-	-	M
1	ST_REV	Simple	Unsigned16	N	2	r	C/a	-	0	M
2	TAG_DESC	Simple	OctetString	S	32	r,w	C/a	I	''	M
3	STRATEGY	Simple	Unsigned16	S	2	r,w	C/a	I	0	M
4	ALERT_KEY	Simple	Unsigned8	S	1	r,w	C/a	I	0	M
5	TARGET_MODE	Simple	Unsigned8	S	1	r,w	C/a	F	-	M
6	MODE_BLK	Record	DS-37 D	D	3	r	C/a	-	block spec.	M
7	ALARM_SUM	Record	DS-42 D	D	8	r	C/a	-	0,0,0,0	M
8	BATCH	Record	DS-67 S	S	10	r,w	C/a	I	0,0,0,0	M



5.2.2 Parameter Attributes of the Physical Block

Relative Index	Parameter Name	Object Type	Data Type	Store	Size	Access	Parameter Usage / Kind of Transport	Reset Class	Default Value	Mandatory Optional (Class A, B)
... Standard Parameters see 5.2.1										
Additional Physical Block Parameters										
8	SOFTWARE_REVISION	Simple	VisibleString	Cst	16	r	C/a	-	-	M
9	HARDWARE_REVISION	Simple	VisibleString	Cst	16	r	C/a	-	-	M
10	DEVICE_MAN_ID	Simple	Unsigned16	Cst	2	r	C/a	-	-	M
11	DEVICE_ID	Simple	VisibleString	Cst	16	r	C/a	-	-	M
12	DEVICE_SER_NUM	Simple	VisibleString	Cst	16	r	C/a	-	-	M
13	DIAGNOSIS	Simple	OctetString	D	4	r	C/a	-	-	M
14	DIAGNOSIS_EXTENSION	Simple	OctetString	D	6	r	C/a	-	-	O
15	DIAGNOSIS_MASK	Simple	OctetString	Cst	4	r	C/a	-	-	M
16	DIAGNOSIS_MASK_EXTENSION	Simple	OctetString	Cst	6	r	C/a	-	-	O
17	DEVICE_CERTIFICATION	Simple	VisibleString	Cst	32	r	C/a	-	-	O
18	WRITE_LOCKING	Simple	Unsigned16	N	2	r,w	C/a	F	-	O
19	FACTORY_RESET	Simple	Unsigned16	S	2	r,w	C/a	F	-	O
20	DESCRIPTOR	Simple	OctetString	S	32	r,w	C/a	I	-	O
21	DEVICE_MESSAGE	Simple	OctetString	S	32	r,w	C/a	I	-	O
22	DEVICE_INSTAL_DATE	Simple	OctetString	S	16	r,w	C/a	I	-	O
23	LOCAL_OP_ENA	Simple	Unsigned8	N	1	r,w	C/a	F	1	O
24	DENT_NUMBER_SELECTOR	Simple	Unsigned8	S	1	r,w	C/a	-	127	M (B)
25	HW_WRITE_PROTECTION	Simple	Unsigned8	D	1	r	C/a	-	-	O
26	FEATURE	Record	DS-68	N	8	r	C/a	-	-	M
27	COND_STATUS_DIAG	Simple	Unsigned8	S	1	r,w	C/a	F	1	M
28	DIAG_EVENT_SWITCH	Record	Diag_Event_Switch	S	50	r,w	C/a	F	-	O
29..32	Reserved by PI									
33	Reserved by Manufacturer									
Additional Manufacturer Physical Block Parameters										
34	DSP_TYPE_INDEX	Simple	Unsigned8	S	1	r,w	C/a	F	2	M
35	DSP_DECIMAL_POINT	Simple	Unsigned8	S	1	r,w	C/a	F	2	M



5.2.3 Parameter Attributes of the Pressure Transducer Block

Relative Index	Parameter Name	Object Type	Data Type	Store	Size	Access	Parameter Usage / Kind of Transport	Reset Class	Default Value	Download Order	Mandatory Optional (Class A,B)
... Standard Parameters see 5.2.1											
Additional Pressure Transducer Block Parameters											
8	SENSOR_VALUE	Simple	Float	D	4	r	C/a	-	-	-	M (B)
9	SENSOR_HI_LIM	Simple	Float	N	4	r	C/a	-	-	-	M (B)
10	SENSOR_LO_LIM	Simple	Float	N	4	r	C/a	-	-	-	M (B)
11	CAL_POINT_HI	Simple	Float	S	4	r,w	C/a	F	-	-	M (B)
12	CAL_POINT_LO	Simple	Float	S	4	r,w	C/a	F	-	-	M (B)
13	CAL_MIN_SPAN	Simple	Float	N	4	r	C/a	-	-	-	M (B)
14	SENSOR_UNIT	Simple	Unsigned16	S	2	r,w	C/a	F	-	2	M (B)
15	TRIMMED_VALUE	Record	101	D	5	r	C/a	-	-	-	M (B)
16	SENSOR_TYPE	Simple	Unsigned16	N	2	r	C/a	-	-	-	M (B)
17	SENSOR_SERIAL_NUMBER	Simple	Unsigned32	N	4	r	C/a	-	-	-	M (B)
18	PRIMARY_VALUE	Record	101	D	5	r	C/a	-	-	-	M (B)
19	PRIMARY_VALUE_UNIT	Simple	Unsigned16	S	2	r,w	C/a	F	-	3	M (B)
20	PRIMARY_VALUE_TYPE	Simple	Unsigned16	S	2	r,w	C/a	I	-	-	M (B)
21	SENSOR_DIAPHRAGM_MATERIAL	Simple	Unsigned16	S	2	r,w	C/a	I	-	-	O (B)
22	SENSOR_FILL_FLUID	Simple	Unsigned16	S	2	r,w	C/a	I	-	-	O (B)
23	SENSOR_MAX_STATIC_PRESSURE	Simple	Float	N	4	r	C/a	-	-	-	O (B)
24	SENSOR_O_RING_MATERIAL	Simple	Unsigned16	S	2	r,w	C/a	I	-	-	O (B)
25	PROCESS_CONNECTION_TYPE	Simple	Unsigned16	S	2	r,w	C/a	I	-	-	O (B)
26	PROCESS_CONNECTION_MATERIAL	Simple	Unsigned16	S	2	r,w	C/a	I	-	-	O (B)
27	TEMPERATURE	Record	101	D	5	r	C/a	-	-	-	O (B)
28	TEMPERATURE_UNIT	Simple	Unsigned16	S	2	r,w	C/a	F	-	4	O (B)
29	SECONDARY_VALUE_1	Record	101	D	5	r	C/a	-	-	-	O (B)
30	SECONDARY_VALUE_1_UNIT	Simple	Unsigned16	S	2	r,w	C/a	F	-	5	O (B)
31	SECONDARY_VALUE_2	Record	101	D	5	r	C/a	-	-	-	O (B)
32	SECONDARY_VALUE_2_UNIT	Simple	Unsigned16	S	2	r,w	C/a	F	-	6	O (B)
33	LIN_TYPE	See Profile 3.01 3.8.2, Table 55.								1	M (B)
34	SCALE_IN	Array	Float	S	8	r,w	C/a	F	-	7	O (B)
35	SCALE_OUT	Array	Float	S	8	r,w	C/a	F	-	8	O (B)
36	LOW_FLOW_CUT_OFF	Simple	Float	S	4	r,w	C/a	F	-	-	O (B)
37	FLOW_LIN_SQRT_POINT	Simple	Float	S	4	r,w	C/a	F	-	-	O (B)
38...44	non-optional										
45	MAX_SENSOR_VALUE	Simple	Float	N	4	r,w	C/a	I	-	-	O (B)
46	MIN_SENSOR_VALUE	Simple	Float	N	4	r,w	C/a	I	-	-	O (B)
47	MAX_TEMPERATURE	Simple	Float	N	4	r,w	C/a	I	-	-	O (B)
48	MIN_TEMPERATURE	Simple	Float	N	4	r,w	C/a	I	-	-	O (B)
49...58	Reserved by PI										
Additional Manufacturer Pressure Transducer Block Parameters											
59	ZERO_ADJUSTMENT	Simple	Float	S	4	r,w	C/a	F	form instrument board	-	M (B)
60	RE_INIT_SENSOR	Simple	Unsigned8	D	1	r,w	C/a	F	0	-	M (B)
61	LOW_PRESS_CUT	Simple	Float	S	4	r,w	C/a	F	0	-	M (B)



62	ELEC_DAMP	Simple	Float	S	4	r,w	C/a	F	0	-	M(B)
----	-----------	--------	-------	---	---	-----	-----	---	---	---	------



5.2.4 Parameter Attributes for the Analog Input Function Block

Relative Index	Parameter Name	Object Type	Data Type	Store	Size	Access	Parameter Usage / Kind of Transport	Reset Class	Default Value	Download Order	Mandatory Optional (Class A, B)
... Standard Parameters see 5.2.1											
Additional Analog Input Function Block Parameters											
10	OUT	Record	101	D	5	r	O/cyc	-	measured of the variable, state	-	M (A,B)
11	PV_SCALE	Array	Float	S	8	r,w	C/a	F	100,0	1	M (A,B)
12	OUT_SCALE	Record	DS-36	S	11	r,w	C/a	F	100,0	3	M (B)
13	LIN_TYPE	Simple	Unsigned8	S	1	r,w	C/a	F	0-	2	M (B)
14	CHANNEL	Simple	Unsigned16	S	2	r,w	C/a	F	-	-	M (B)
16	PV_FTIME	Simple	Float	S	4	r,w	C/a	F	0	-	M (A,B)
17	FSAFE_TYPE	Simple	Unsigned8	S	1	r,w	C/a	F	1	-	O (B)
18	FSAFE_VALUE	Simple	Float	S	4	r,w	C/a	F	-	-	O (B)
19	ALARM_HYS	Simple	Float	S	4	r,w	C/a	F	0.5% of range	-	M (A,B)
21	HI_HI_LIM	Simple	Float	S	4	r,w	C/a	F	max value	4.1	M (A,B)
23	HI_LIM	Simple	Float	S	4	r,w	C/a	F	max value	4.2	M (A,B)
25	LO_LIM	Simple	Float	S	4	r,w	C/a	F	min value	4.3	M (A,B)
27	LO_LO_LIM	Simple	Float	S	4	r,w	C/a	F	min value	4.4	M (A,B)
30	HI_HI_ALM	Record	DS-39	D	16	r	C/a	-	0	-	O (A,B)
31	HI_ALM	Record	DS-39	D	16	r	C/a	-	0	-	O (A,B)
32	LO_ALM	Record	DS-39	D	16	r	C/a	-	0	-	O (A,B)
33	LO_LO_ALM	Record	DS-39	D	16	r	C/a	-	0	-	O (A,B)
34	SIMULATE	Record	DS-50	S	6	r,w	C/a	F	disable	-	M (B)
35	OUT_UNIT_TEXT	Simple	OctetString	S	16	r,w	C/a	-	-	-	O (A,B)
36...44	Reserved by PI										



5.3 Function Configuration

5.3.1 Setting the PROFIBUS Station Address

It only supports device address set by hardware DIP switch. After setting device address, the device will use new address after it is powered again. In addition, it doesn't support the service setting via SET_SLAVE_ADDRESS.

5.3.2 Integration Using GSD

PROFIBUS devices differ with respect to available functionality and parameters for each device type and manufacturer. In order to obtain 'Plug-and-Play' configuration for PROFIBUS, characteristic device communication features such as manufacturer name, device name, hardware / software versions, baudrate and the number and nature of inputs / outputs are defined in an electronic device data sheet known as a GSD (Generic Station Description) file.

A GSD file is readable ASCII text file that contains both general and device-specific specifications for communication. Each of the entries describes a feature supported by a device. By using keywords, a configuration tool reads the device identification, the adjustable parameters, the corresponding data type and the permitted limit values for the configuration of the device from the GSD. Some keywords are mandatory, for example, Vendor_Name; others are optional, for example, Sync_Mode_supported.



The GSD file for NCS-PT105 II S Profibus DP Pressure Transmitter specifies the device-specific Ident No. 0x0B25. It conforms to the PROFIBUS standard, providing a clear and comprehensive description of each instrument in a precisely defined format.

This enables the system configuration tool to use the information automatically when configuring a PROFIBUS bus system.

5.3.3 Configuration using Device Type Manager (DTM) Software

The NCS-PT105 II S Profibus DP Pressure Transmitter DTM can be used for acyclic parameter configuration and monitoring of measurement values using a suitable PC-based FDT 1.2/1.2.1 frame application tool and a Class 2 PROFIBUS master (with its corresponding Communication DTM).





Figure 5.1 Device DTM

5.3.4 Configuration using an EDD

Similar to the use of a DTM, configuration of DP Pressure Transmitter parameters and monitoring of measurement values is possible using an EDD interpreter application (e.g. SIMATIC PDM) with the DP Pressure Transmitter EDD file.

Before installing device EDD, please add manufacture info.

Find manufacturer.csv file in...\\Siemens\Step7\S7BIN.

Add “Microcyber Inc.;Microcyber Inc.;;;;Microcyber Inc.;0x016C”.

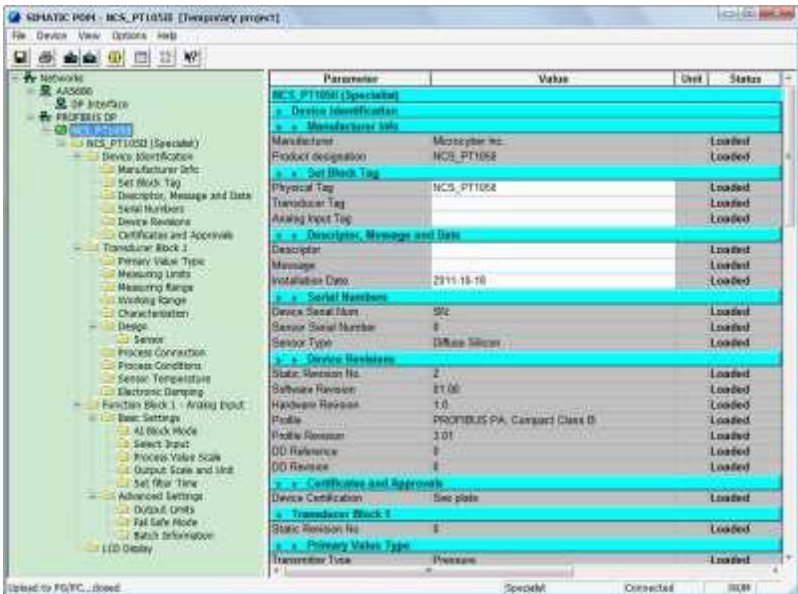

Figure 5.2 SIMATIC PDM



Chapter 6 Technical Specification

Pressure Range (bar)	0.2	0.35	1	3.5	7	10	25	35	60	100	350
Over Pressure Safety (%)	300	300	200	200	200	200	200	200	200	200	150
Process Wetted Part											
Isolating Diaphragm	316L Stainless steel										
Process Connector	304 Stainless steel					O-ring: NBR					
Electronics Housing	Low-copper Aluminum										
Sensor Filling Fluid	Silicone oil										
Power Supply	10~30VDC (Reverse polarity protection)										
Signal Output	Profibus® DP protocol in compliance with EN 50170 / DIN 19245										
Termination	Internal termination can be activated via integrated DIP switch										
Update Rate	≥10HZ										
Display	LCD										
Insulation Voltage	707Vrms (1000VDC)										
Base Accuracy	0.075 % of calibrated span										
Ambient Temperature Effect	per 50 °F (28 °C) ±(0.025% URL + 0.125% of span)										
One-year Stability	≤ 0.10% of span										
Permissible Temperature of											
Medium	-40 ... +125°C										
Ambience	-40 ... +85°C										
Storage	-40 ... +85°C										
Compensated Temperature Range	-30 ... +70°C										
EMC	According to IEC 61326										
Protection Degree	IP67										
Electrical Connection	1/2-14NTP, female										
Weight	Approx. 1.8 kg										



Appendix 1 Smart Pressure Transmitter Selection

Model		Product Description (Select One)
NCS-PT105 II S SG		Gauge pressure transmitter
NCS-PT105 II S SA		Absolute pressure transmitter
Code	Range	
0	200 mbar(20 kPa)	
1	350 mbar(35 kPa)	
2	1bar(100 kPa)	
3	3.5 bar(350 kPa)	
4	7 bar(700 kPa)	
5	10 bar(1 MPa)	
6	25 bar(2.5 MPa)	
7	35 bar(3.5 MPa)	
8	60 bar(6 MPa)	
9	100 bar(10 MPa)	
A	350 bar(35 MPa)	
Code	Protocol	
D	Profibus DP Protocol	
Code	Process connection	
	Conduit Thread with Standard Diaphragm	
GA	ISO 228 G1/2 , inside hole 3 mm	
GE	ISO 228 G1/2 (outside),G 1/4(inside)	
GH	ISO 228 G1/2 , inside hole 11.4mm	
RA	ANSI 1/2 MNPT,1/4 FNPT	
RD	ANSI 1/2 MNPT , inside hole 11.4 mm	
RH	ANSI 1/2 FNPT	
GL	JIS B0202 PF 1/2(male)	



RL	JIS B0203 Pt 1/2(male)
----	------------------------



GP	M20×1.5, inside hole 3mm
Code	Process connection
	Conduit Thread with Flush Diaphragm
1G	ISO 228 G 11/2A
1K	ISO 228 G 2 A
2D	ANSI 11/2 MNPT
2G	ANSI 2 MNPT
1R	M 44×1.25
Code	Display
M	LCD module
Example:NCS-PT105 II S SG 2 DGP M	



MICROCYBER

YOUR FIELDBUS EXPERT

CONTACT INFORMATION

**Address: 17-8 Wensu Street, Hunnan New District,
Shenyang, China**

Website: <http://www.microcyber-fieldbus.com>

Phone: +86-24-31217278/+86-24-31217280

Fax: +86-24-31217338

Email: fang.siqi@microcyber.cn