



MC0312  
Ethernet-APL Built-in Core Module  
**User Manual**

## Warning

1. It is forbidden for users to disassemble components by themselves.
2. Please check whether the power supply voltage of the gateway is in accordance with the power supply voltage requirement in the user manual.

**Version: V1.0**

### Disclaimers

The contents of this manual have been checked to confirm the consistency of the hardware and software described. Since errors cannot be completely excluded, absolute consistency cannot be guaranteed. However, we will periodically check the data in this manual and make the necessary corrections in subsequent versions. Any suggestions for improvements are welcome.

**Microcyber Corporation 2024**

Technical data is subject to change at any time.

## Company Profile

**Microcyber Corporation** is a high-tech enterprise initiated and founded by Shenyang Institute of Automation, Chinese Academy of Sciences, mainly engaged in networked control system, industrial communication and instrumentation, development, production and application. Microcyber Corporation has undertaken a number of national science and technology projects such as the National Science and Technology Major Project, National High Technology Research and Development Program (863 Program), Smart Manufacturing Equipment Development Project, etc. It is the unit for the construction of National Engineering Research Center for Networked Control System.

Microcyber Corporation successfully developed the first internationally certified fieldbus protocol master stack, the first nationally certified fieldbus instrument, the first domestic safety instrument certified by TÜV Germany, and co-hosted with other units the formulation of the first domestic industrial Ethernet protocol standard EPA and the first industrial wireless communication protocol standard WIA-PA, which became an IEC international standard.

Our products and technologies have won two National Science and Technology Progress Awards, one National Science and Technology Invention Award, one First Prize of Science and Technology Progress of Chinese Academy of Sciences, one First Prize of Science and Technology Progress of Liaoning Province, and our products have been exported worldwide. We have successfully completed more than 200 large-scale automation projects.

Microcyber Corporation is a member of FCG organization; a member of PNO.

Microcyber Corporation has successfully passed ISO9001:2008 quality management system certification and ISO/TS16949 quality system certification for the automotive industry. Excellent R&D team, rich experience in automation engineering design and implementation, industry-leading products, large market network and excellent corporate culture have laid a solid foundation for the company's start-up and sustainable development.

Carrying employees' ideals, creating customer value and promoting corporate development.

## Table of Contents

Chapter 1 Overview .....	2
1.1 Features .....	2
1.1.1 Same Size .....	2
1.1.2 Same Interface .....	2
1.1.3 Easy to Upgrade .....	2
1.1.4 Simple Configuration .....	3
1.2 Overall Dimensions .....	3
1.3 Module Structure .....	3
Chapter 2 Module Installation and Working Principle .....	4
2.1 External Interface of Module .....	4
2.2 Introduction to Module Interface Functions .....	4
2.3 Conversion Logic .....	5
2.4 Configure Interface .....	6
Chapter 3 Device Configuration .....	8
3.1 Introduction to Configuration Tools .....	8
3.2 Configure Modbus Interface .....	11
3.3 Configure Device Variables .....	12
3.4 Configure Dynamic Variables .....	14
3.5 Variable Monitoring .....	15
Chapter 4 Other Configurations .....	16
4.1 Configure PV Range .....	16
4.2 Configure Scaling Factor .....	17
4.3 Debugging Calibration Area Operations .....	18
4.4 Data Saving and Restoration .....	18
4.5 Batch Download .....	19
Chapter 5 Ethernet-APL Equipment Development Solution .....	20
5.1 Application of MC0312 Module in Pressure Transmitter .....	20
5.2 MC0312 Module for Flow Meter Applications .....	21
5.3 Ethernet-APL Module Application Example .....	22
Chapter 6 Maintenance .....	23
Chapter 7 Technical Specifications .....	24
7.1 Basic Parameters .....	24
7.2 Physical Properties .....	24

# Chapter 1 Overview

MC0312 Ethernet-APL built-in core module is a 10BASE-T1L (IEEE 802.3cg) compliant miniaturised module developed by Microcyber, supporting bus power supply, communication rate of 10Mbps, and a maximum communication distance of 1000 m. MC0312 Ethernet-APL Built-in Core Module The software protocol supports Modbus-RTU master and HART-IP slave functions, which can quickly upgrade the user's Modbus devices to HART-IP protocol devices that support APL physical layer. Meanwhile, MC0312 is also one of Microcyber MC series built-in core modules. This series of built-in core module has the same size, the same interface, easy to upgrade, simple configuration, etc. It is the ideal choice for users to quickly develop fieldbus devices. The physical appearance of MC0312 Ethernet-APL built-in core module is shown in Figure 1 below:

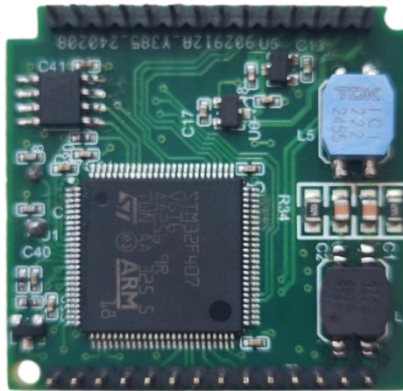

Figure 1 MC0312 Ethernet-AP Built-in Core Module

## 1.1 Features

### 1.1.1 Same Size

Microcyber' s MC series built-in core modules have the same size, 35mm (length) \* 35mm (width).

### 1.1.2 Same Interface

Microcyber' s MC series built-in core modules adopt 2.0 spacing double row 14 pin connectors, which are functionally compatible.

### 1.1.3 Easy to Upgrade

Replace different built-in core modules of Microcyber' s MC series, and immediately implement devices with different protocols.

### 1.1.4 Simple Configuration

It is easy to operate and use by using the special configuration tool of Microcyber.

## 1.2 Overall Dimensions

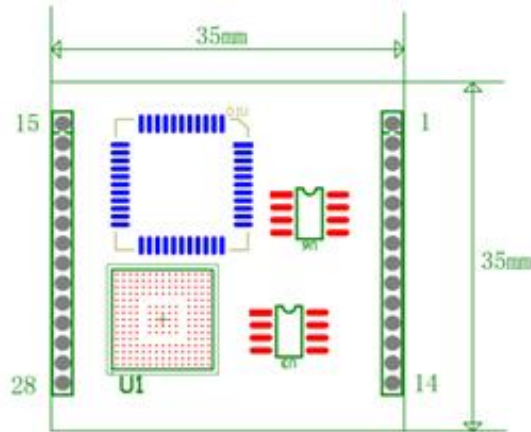

Figure 2 External dimensions of built-in core module (unit: mm)

## 1.3 Module Structure



Figure 3 Structure of MC0312 built-in core module

# Chapter 2 Module Installation and Working Principle

## 2.1 External Interface of Module

The interface distribution and definition of the MC0312 Ethernet-APL built-in core module are shown in Table 1 below:

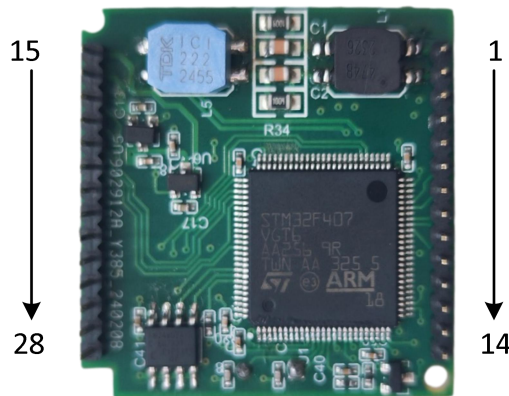

Figure 4 MC0312 built-in core module interface definition

## 2.2 Introduction to Module Interface Functions

Table 1 Interface definition

Pin	Name	Description
1	TDO	JTAG debugging interface
2	TDI	JTAG debugging interface
3	RESET	Reset
4	GND	Reference end
5	TMS	JTAG debugging interface
6	RXD	Serial receive
7	TXD	Serial send
8	TCK	JTAG debugging interface
9	SPISTE	GPIO, SPI interface
10	SOMI	GPIO, SPI interface
11	SIMO	GPIO, SPI interface

12	SPICLK	GPIO, SPI interface
13	VCC-3.3V	3.3V power output
14	VCC-5V	5V power output
15	GPIO	GPIO
16	GPIO	GPIO
17	GPIO	GPIO
18	GPIO	GPIO
19	GPIO	GPIO
20	GPIO	GPIO
21	GPIO	GPIO
22	I2CSCL	GPIO, I2C interface
23	I2CSDA	GPIO, I2C interface
24	GPIO	GPIO
25	GPIO	GPIO
26	GND	Reference end
27	APL+	Bus power positive
28	APL-	Bus power negative

## 2.3 Conversion Logic

MC0312 Ethernet-APL built-in core module is an built-in module that can convert Modbus protocol devices into HART-IP protocol devices that support the Ethernet-APL physical layer. The MC0312 module is built in Modbus protocol equipment (temperature, pressure, flow, level, actuator and other instruments) and is connected to the instrument through the TTL serial port. The communication protocol with the instrument is the Modbus-RTU protocol. The MC0312 module supports Modbus master station and HART-IP slave station functions, and can convert data from data registers (such as input registers and holding registers) in Modbus devices into dynamic variables corresponding to HART-IP commands. For example, the holding register with address 30000 (range 1-65536) in a flow meter stores the instantaneous flow value, then we can configure the holding register to device variable 0 (range 0-5) of the HART-IP module, Then specify device variable 0 as the main variable (or second, third, or fourth variable). The conversion logic is shown in Figure 5 below:

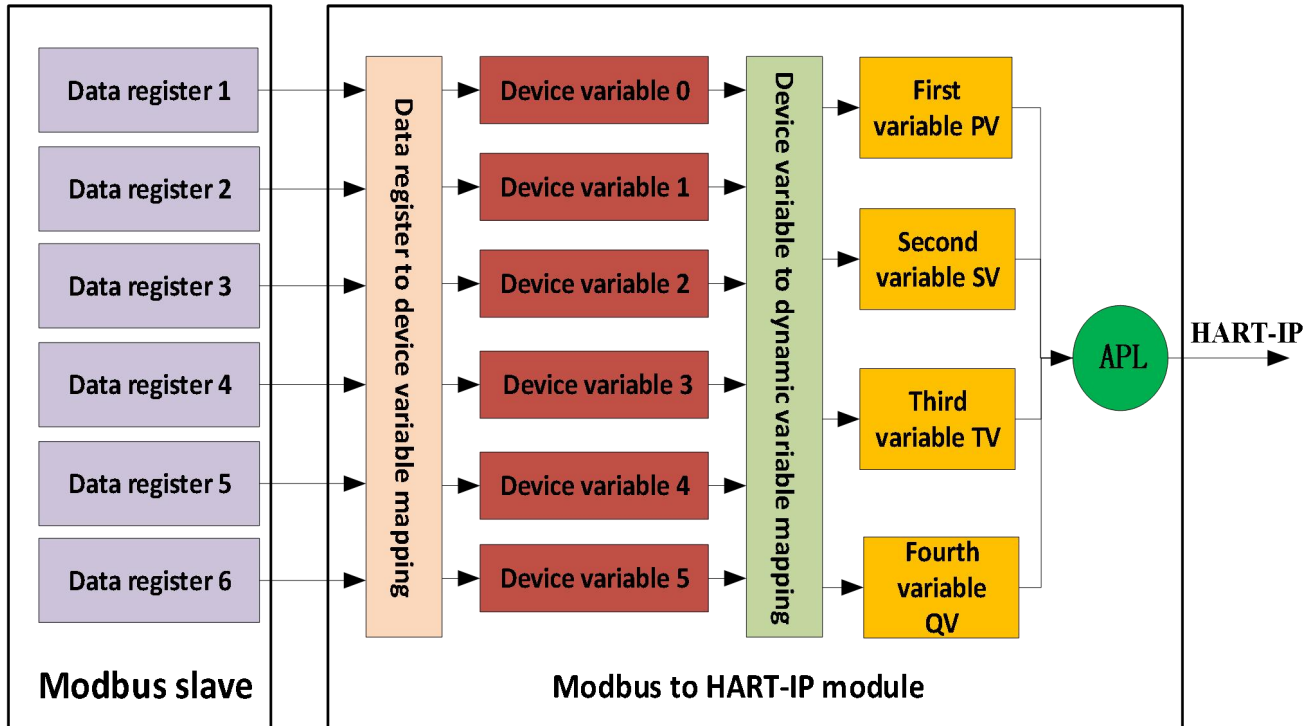

Figure 5 MC0312 data mapping logic diagram

As a universal module, the MC0312 module can be adapted to all Modbus instruments on the market. When using the MC0312 module, users can use the HART-IPMPT configuration software provided by Microcyber to complete the relevant function configuration of the module. The specific configuration information includes the following:

- Configure Modbus communication parameters, such as slave address, communication rate, and communication verification method;
- Configure data storage method, including data register address, data type, byte order, etc.;
- Configure HART-IP dynamic variable data registers to map to device variables, and device variables to dynamic variables;
- Configure IP address, etc.;

After the above configuration, the HART-IP master station device can access the dynamic variables in the MC0312 module using HART-IP commands, thereby realizing the data in the Modbus data register (such as storing the instantaneous flow value of the flow meter) to the HART-IP master station of digital transmission.

## 2.4 Configure Interface

The MC0312 module can realize the conversion function between Modbus protocol and HART-IP protocol. The module can be directly plugged into the user equipment circuit board. It is externally connected to the HART-IP master device through the Ethernet-APL physical layer and internally connected to the Modbus device through the TTL interface. The module The configuration wiring diagram is shown below.

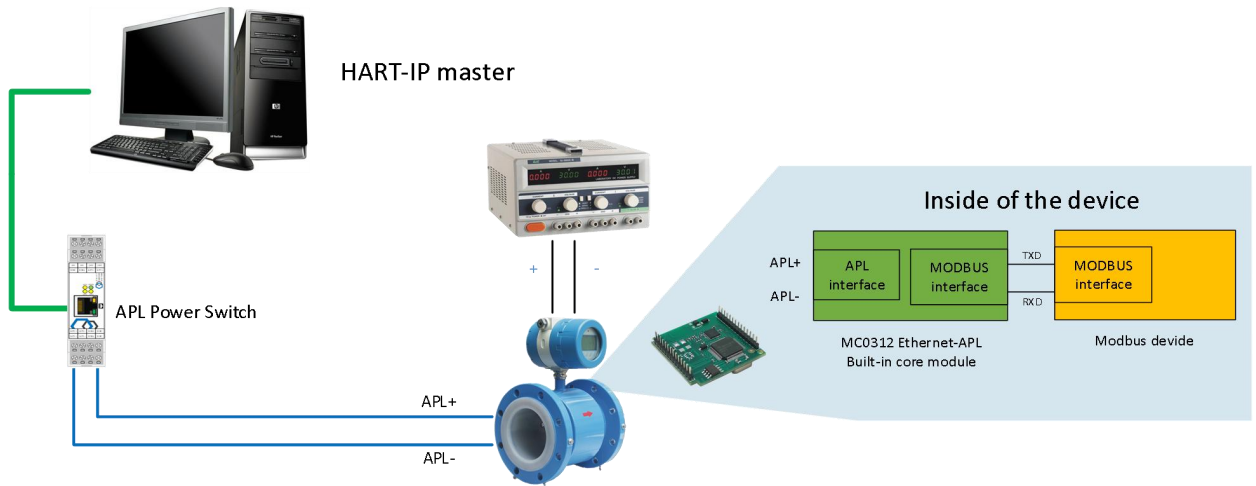

Figure 6 MC0312 module configuration wiring diagram

The PC is used as the master station device to run the HART-IP MPT configuration software of Microcyber. One end of the APL power switch is connected to the PC through conventional Ethernet. The Ethernet-APL interface of the power switch is connected to the on-site APL equipment and provides APL. The device is powered. After the connection is completed, the MC0312 module can be configured using the HART-IP MPT configuration software.

# Chapter 3 Device Configuration

## 3.1 Introduction to Configuration Tools

The HART-IP MPT host computer configuration software is a configuration tool specially developed for the MC0312 module. The HART-IP MPT configuration software has the HART-IP master station function and can communicate and configure the MC0312 module through the HART-IP protocol. The HART-IP MPT configuration software initialization interface is shown in Figure 7 below.

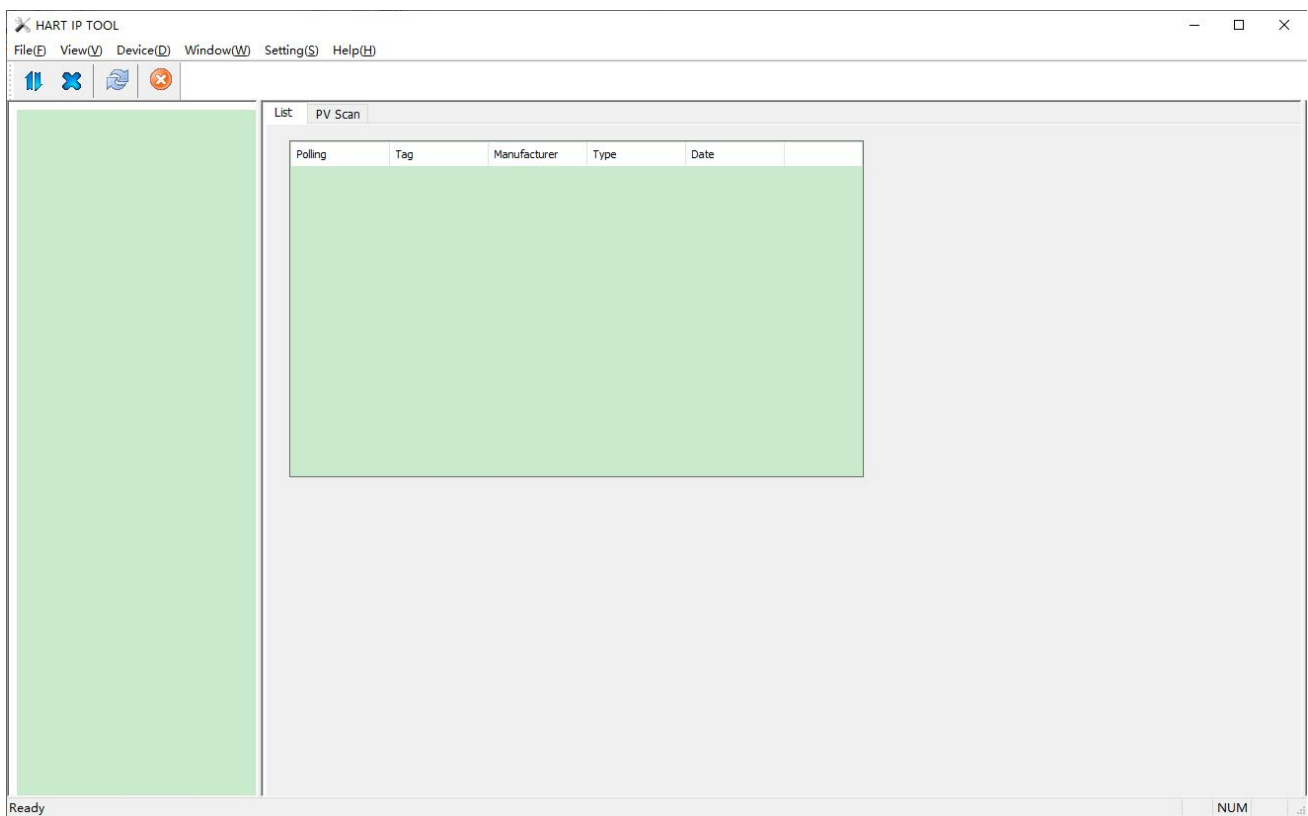



Figure 7 Configuration software icon and initial interface

Click Settings and select Network Settings in the pop-up menu, or click  to pop up the Network Settings dialog box. Set the network information in the Network Settings dialog box (as shown in the picture). You can select the network protocol, TCP or UDP, and select Network After the agreement, you can fill in the device IP, for example: 192.168.2.151. The default port is 5094. You can also fill in other ports. It is recommended to use the default. Click OK to connect to the network. If the connection is successful, the device information of the successfully connected device will be displayed in the list on the left, in the format of IP address plus port number. Figure 9 below shows the display of the device when the connection is successful.

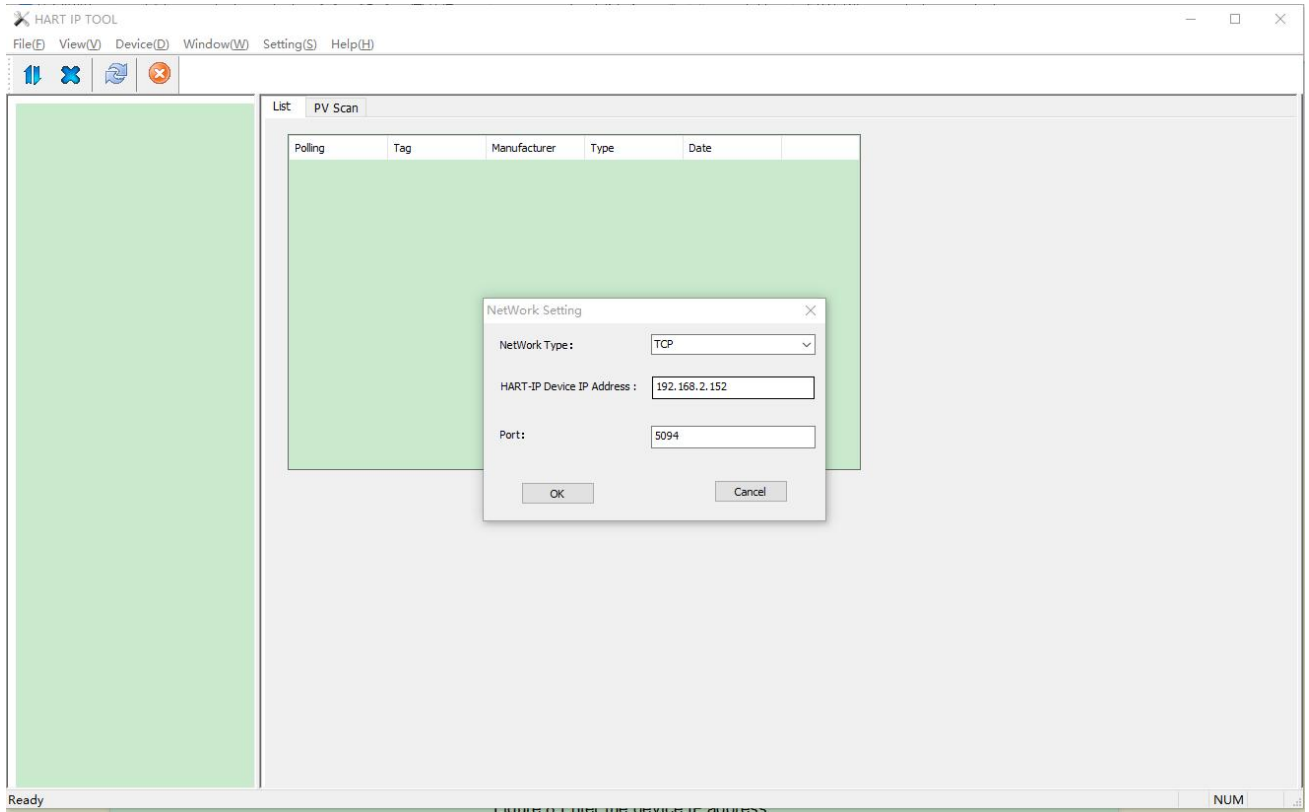

Figure 8 Enter the device IP address

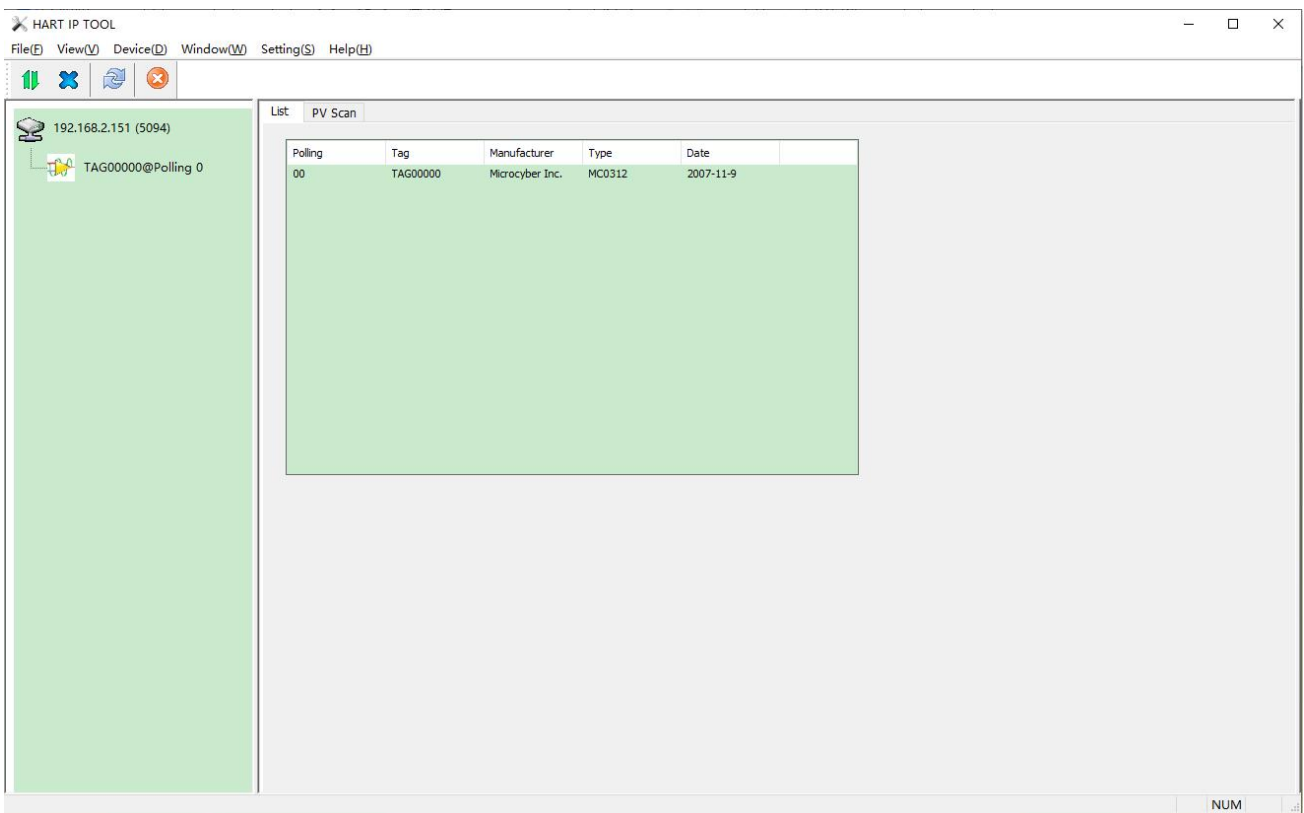

Figure 9 Displaying successfully connected devices

The figure shows that the device with the short address '0' (hereinafter referred to as device No. 0) is online. Left-click the device No. 0 with the mouse. After the configuration software continuously communicates with the MC0312 module, the tab view changes as shown below:

Info Device Scan Modbus to Hart Setting Burst configure

**Transmitter Information**

Polling:

Message:

Description:

Long Tag:

Tag:  Alarm Type:

Date:  /  /  Write Protect:

Assembly:  Vendor ID:

**Identification**

Manufacturer:

Type:

Device ID:

Unique ID:

**Revision**

Universal:

Device:

Hardware:

Software:

Figure 10 MC0312 module basic information page

The 'Gateway Configuration' option is mainly to configure the Modbus communication parameters of MC0312. After configuration, MC0312 can communicate with Modbus instruments and obtain instrument data. The gateway configuration interface is shown in the figure below:

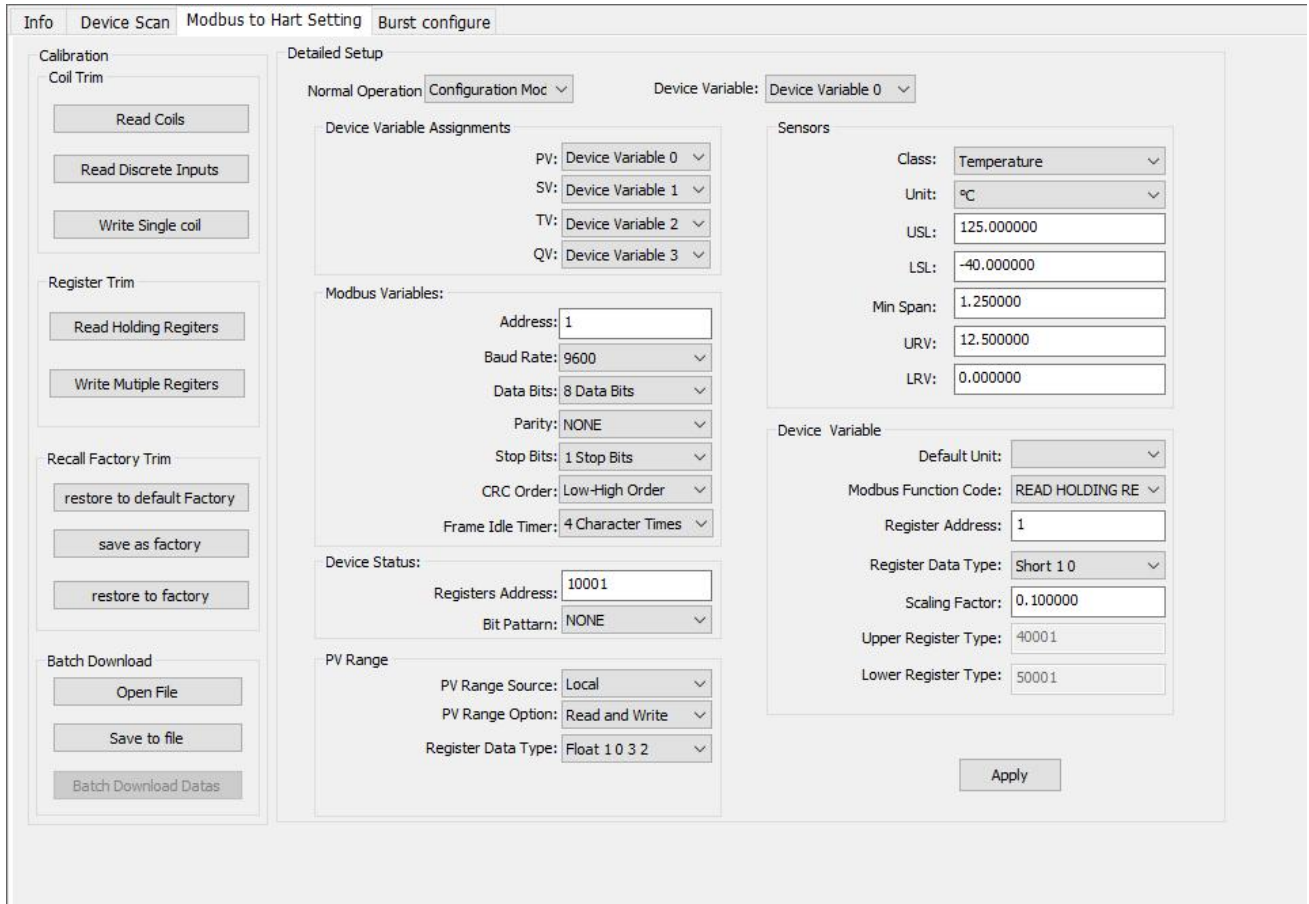

Figure 11 Gateway configuration tab

Note: If you want to configure the MC0312 module, first change the 'Gateway Configuration\Detailed Settings\Operating Mode' option group to 'Configuration Mode'. In this mode, the user can operate other functional items in the detailed settings; in the configuration mode Under this condition, the MC0312 module will not actively send Modbus request packets to the user device in a loop.

After the configuration is completed, the operating mode needs to be set to operating mode.

### 3.2 Configure Modbus Interface

In order to ensure that the MC0312 module can communicate normally with the user's Modbus instrument, it is necessary to use the host computer configuration software to configure the Modbus communication parameters. Using the 'Gateway Configuration\Detailed Settings\Modbus Variables' option group of the configuration software, users can configure Modbus communication parameters according to their own Modbus device interface characteristics, as shown in Figure 12:

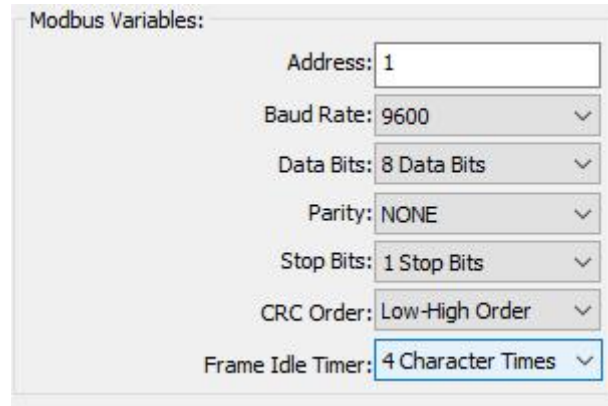

Figure 12 Modbus communication parameters

Parameter meaning:

Table 2 Meaning of Modbus communication parameters

Function name	Purpose	Default parameters
Address	User Modbus slave device address	1
Baud rate	MC0312 module communicates with user equipment through baud rate	9600bps
Data bits	Communication data length between MC0312 module and user equipment	8
Check	Verification method: odd parity, even parity, no parity	EVEN
Stop bit	Number of stop bits	1
CRC byte order	The sending sequence of the last 2-byte CRC of the Modbus protocol data packet	Low-High Order

Only when all the communication parameters in Table 2 fully comply with the user Modbus device interface characteristics can normal communication be guaranteed. After the user sets the parameters, click the ‘Apply’ button to save the configuration data to the MC0312 module.

### 3.3 Configure Device Variables

The configuration of device variables is to configure the process variable data in the user's Modbus device (such as instantaneous flow, cumulative flow, flow rate, medium density, medium temperature and other variables in the flow meter) to the HART-IP device variables of the MC0312 module. The MC0312 module A total of 6 device variable configurations are supported. Use the ‘Gateway Configuration\Detailed Settings\Device Variables’ option group of the HART-IP MPT configuration software to configure. The specific information that needs to be configured is shown in Figure 13:

Figure 13 Device variable configuration

The meaning of each item used in quick configuration is shown in Table 3.

Table 3 Device variable configuration

Device variable n (n=0~5)	
Function name	Purpose
Type	User Modbus device data type, select the corresponding item in the 'Type' drop-down list according to different types (for example: volume flow, temperature, pressure, density, etc.).
Unit	The units currently used and displayed for HART-IP device data (units of PV)
Sensor range upper limit	Maximum limit of device variables that can be captured by the user's Modbus device
Sensor range lower limit	Minimum limit of device variables that can be captured by the user's Modbus device
Minimum span	Range span, generally set to the upper limit of the sensor range divided by 100

Upper limit of measuring range	Between the upper and lower sensor range limits.
Lower limit of measuring range	Between the upper and lower sensor range limits.
Default unit	The unit of the variable value read from the Modbus device.
Modbus function code	Function code to be sent when reading device variable n.
Register address	Data register address of the device variable in the Modbus device.
Register data type	Byte order of the device variable in the Modbus data registers

Among them, the upper limit of the measurement range and the lower limit of the measurement range can only be modified when the current device variable is mapped to the main variable; the upper/lower limit of the measurement range of the device variable here is the same parameter as the upper/lower limit of the measurement range in the HART-IP device.

Users can configure the process variables in their Modbus devices to these six device variables respectively according to the number and importance of them. After the configuration is completed, click the 'Apply' button to save the data to the MC0312 module;

Note: used in the configuration software ( $\text{data register address} = \text{data register address in user equipment} + 1$ ). For example: If the device variable 0 (flow rate) in the user equipment corresponds to the register with address 30000, then 30001 should be filled in the configuration software.

The relationship between the units in Table 3 and the default units is as follows:

$\text{HART device primary variable value (PV)} = \text{HART-IP device variable n (the value converted from the default unit to the currently used unit)}$

### 3.4 Configure Dynamic Variables

HART-IP supports 4 dynamic variables PV, SV, TV and QV. Using the HART-IP MPT configuration software, any 4 of the 6 device variables can be mapped to the 4 dynamic variables of HART-IP. Use the configuration Configure the 'Gateway Configuration\Detailed Settings\Device Variable Assignment' option group of the software, as shown in Figure 14.

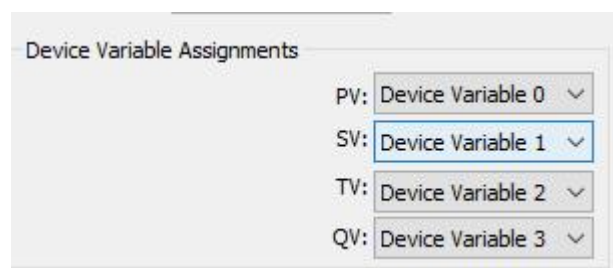

Figure 14 Assignment of device variables to dynamic variables

The HART-IP protocol stipulates that there are 4 dynamic variables, the first variable (ie, the main variable PV), the second variable (SV), the third variable (TV), and the fourth variable (QV); the 6

variables configured by the user in section Each device variable can be mapped to these four dynamic variables without restrictions;

### 3.5 Variable Monitoring

After completing the Modbus communication parameter configuration, device variable configuration and dynamic variable configuration in the above configuration steps, change the 'Gateway Configuration\Detailed Settings\Operating Mode' option group to 'Operating Mode'. After completing the configuration, the MC0312 module will cycle to the user The device sends a request packet of the Modbus protocol to obtain the values of 6 device variables. Open the 'Variable Monitoring' interface of the configuration software to monitor the dynamic variables of HART-IP, as shown in Figure 15:

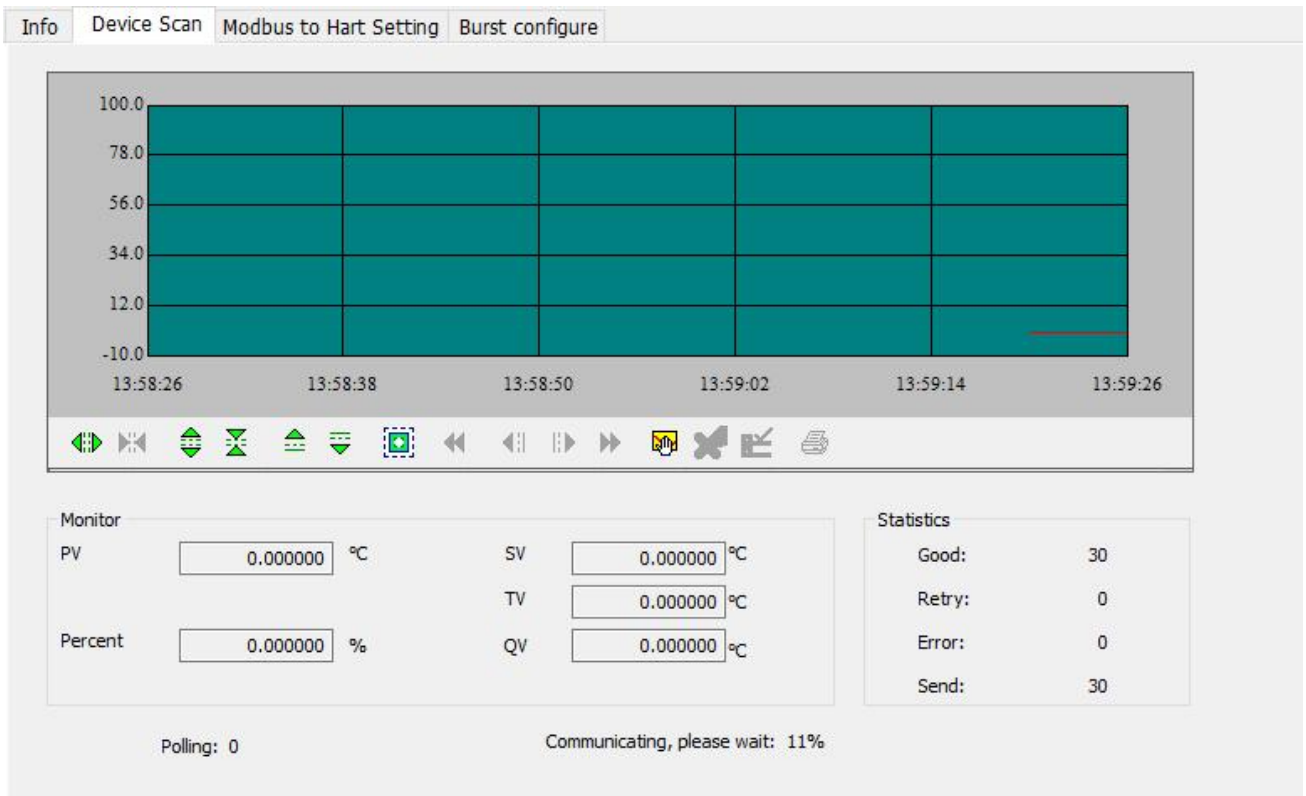

Figure 15 Variable monitoring

## Chapter 4 Other Configurations

The HART-IP MPT configuration software also provides five special configuration functions for users to use the MC0312 module more in-depth. These parts will be described in detail below.

### 4.1 Configure PV Range

Users can configure the source and read-write mode of the upper and lower limits of the main variable range through the 'Gateway Configuration\Detailed Settings\PV Range' option group.

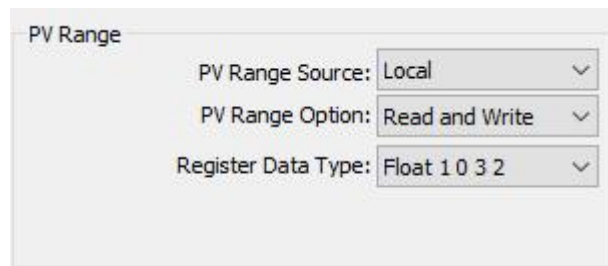

Figure 16 PV range operation

'PV range source' represents whether the upper limit and lower limit of the main variable's range are manually configured through the configuration software or read remotely from the user's Modbus device. 'PV range operation mode' refers to whether in remote mode, the upper and lower limits of the range stored in the user's Modbus device can be read and written. 'Register data type' refers to the storage format in the register of the upper and lower range limits stored in the user's Modbus device in remote mode.

Figure 17 below briefly describes the situation where device variable 0 is mapped to the main variable PV in the two modes of 'local' and 'remote':

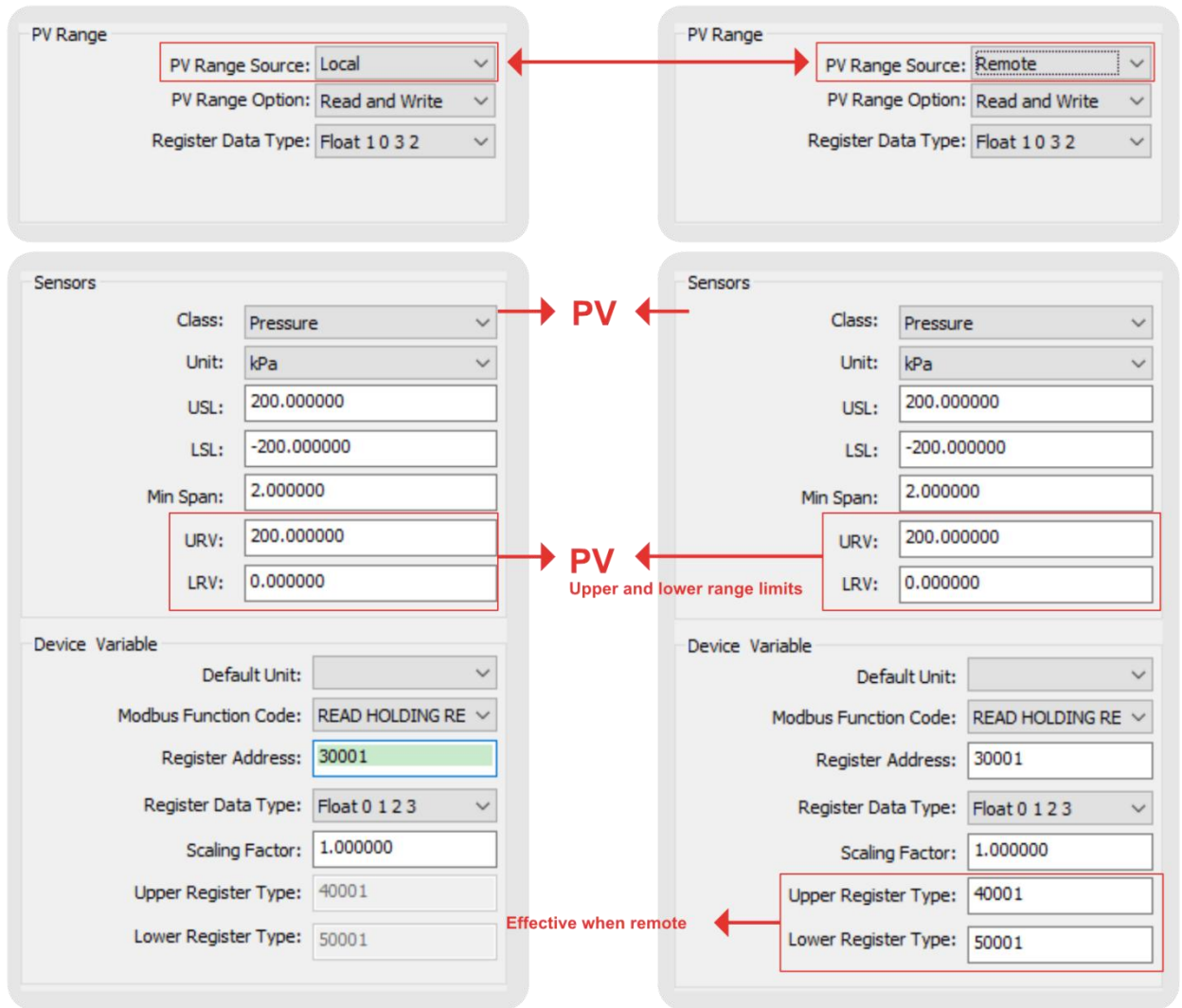

Figure 17 PV range operation example

In the above figure, if device variable 0 is not mapped to a host variable, the upper limit of the range, the lower limit of the range and their register addresses are inoperable. When the 'PV range source' is set to 'remote' and the operation mode is set to 'read and write', after the user sets the upper and lower limits of the range and their register addresses, and clicks the 'Apply' button, the MC0312 module will send the values of the upper and lower limits of the measuring range to the user's Modbus device in the set data type (the default function code is 16, which writes multiple registers); when it is 'read-only', the MC0312 module will periodically read the values specified from the user device. The upper and lower limit registers of the measuring range read the values of the upper and lower limits of the measuring range (the default is to read the holding register).

## 4.2 Configure Scaling Factor

The MC0312 module is also specially equipped with a scaling factor parameter for each device variable to facilitate users to scale the data. The conversion method is:

### HART device variable n = Modbus device variable n \* scaling factor

If the user does not need to perform numerical scaling, there is no need to modify the value of the scaling factor. The factory default is 1.0.

## 4.3 Debugging Calibration Area Operations

The function of the debugging and calibration area is for users to use for joint debugging when configuring the MC0312 module for the first time. The device can be debugged through the 'coil' and 'register' in the 'Gateway Configuration\Calibration' option group of the configuration software. The functional area is shown in Figure 18. Shown:

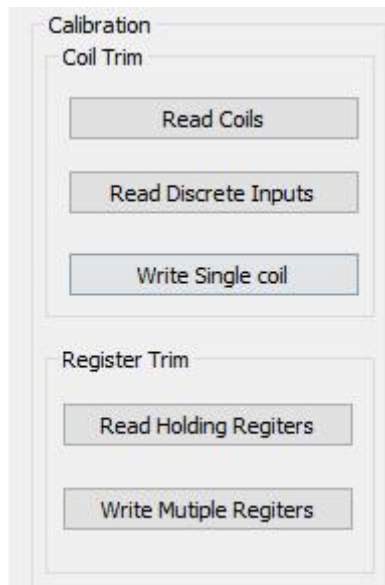

Figure 18 Debugging calibration function

When the user uses the MC0312 module for the first time, after completing the hardware connection and configuring all communication parameters in the 'Gateway Configuration\Detailed Settings\Modbus Variables' option group, the user can use the function as shown in Figure 18. When reading and writing data from Modbus devices, if the returned and written data are correct, it means that the hardware connection and Modbus communication parameters between the MC0312 module and the user device are correct; otherwise, further inspection of the hardware connection or software configuration is required.

## 4.4 Data Saving and Restoration

The data saving and recovery function is realized through the 'Gateway Configuration\Calibration\Restore Factory Settings' option group of the configuration software, as shown in Figure 19:

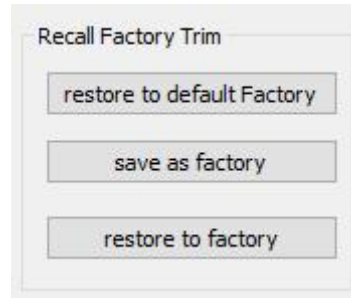

Figure 19 Data saving and recovery

- Restore to factory default values: Restore all configuration data in the MC0312 module to the initial values of the system. Users must use caution. After executing this function, all user-configured data will be lost;
- Save to factory settings: Save all user configuration information as factory values (the data has a backup in the MC0312 module);
- Restore to factory settings: Restore the user configuration information backed up in the MC0312 module when the last 'save to factory values' was executed to the current state of use;

## 4.5 Batch Download

The batch download function is a quick configuration function specially provided for manufacturers to facilitate the configuration of multiple MC0312 modules. This is achieved through the 'Gateway Configuration\Batch Download' option group of the configuration software, as shown in Figure 20:

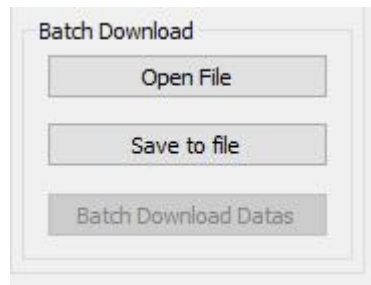

Figure 20 Batch download

When the user has multiple MC0312 modules and needs to perform the same configuration operation, he only needs to configure one MC0312 module, and then click the 'Save to File' button to save the current MC0312 module configuration information as a file; when configuring other MC0312 modules, only You need to click the 'Open File' button to read the configuration information saved in the file, and then click the 'Batch Download Data' button to download all the configuration information displayed on the current page to the MC0312 module to complete the configuration.

# Chapter 5 Ethernet-APL Equipment Development

## Solution

Quickly upgrade your Modbus field devices to Ethernet APL field devices.

MC0312 Ethernet-APL is a cost-effective hardware embedded module for developing Ethernet-APL field devices. In addition to providing the communication protocol interface of Ethernet-APL, it also comes with application software that can be easily configured to achieve the desired behavior of specific field devices. Existing Modbus devices can be directly upgraded to Ethernet-APL devices without even writing code.

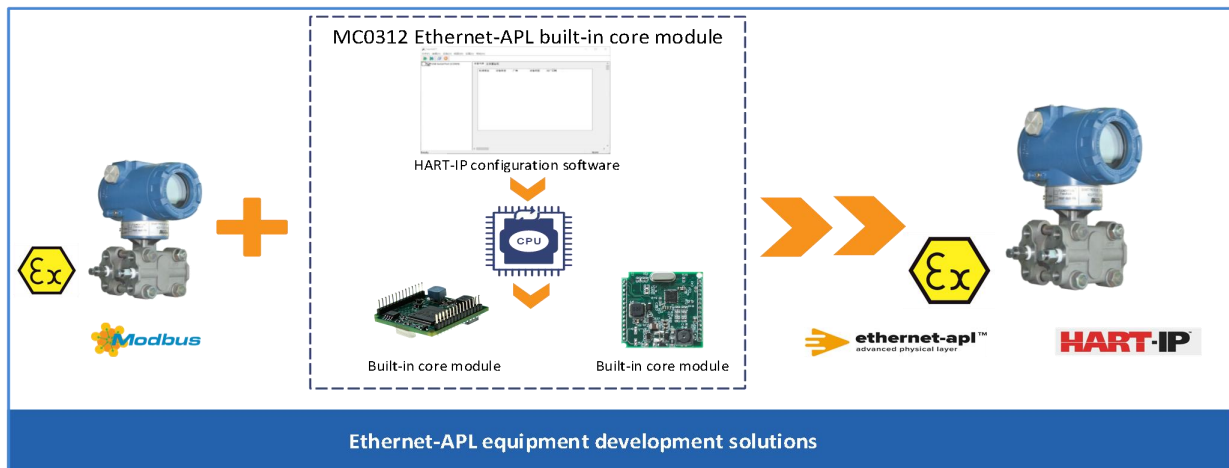

Figure 21 APL equipment development solution

## 5.1 Application of MC0312 Module in Pressure Transmitter

MC0312 Ethernet-APL embedded core module can adapt to all types of instruments on the market, such as temperature, pressure, flow, liquid level, actuator, etc. It can quickly upgrade traditional instruments to Ethernet-APL field devices without users even having to write a line of code. At present, the MC0312 module has been successfully used in Bowei's pressure transmitter products, so that the pressure transmitter supports the Ethernet-APL communication interface and the HART-IP communication protocol.

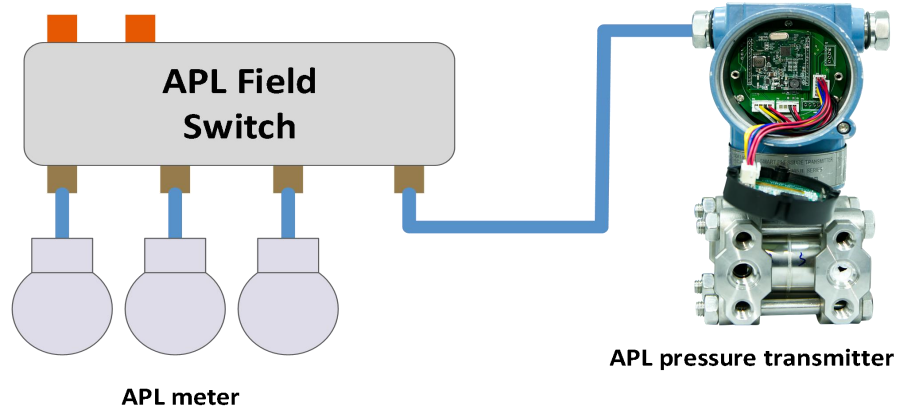

Figure 22 Application of MC0312 module in pressure transmitter

## 5.2 MC0312 Module for Flow Meter Applications

MC0312 Ethernet-APL embedded core module can adapt to all types of instruments on the market, such as temperature, pressure, flow, liquid level, actuator, etc. It can quickly upgrade traditional instruments to Ethernet-APL field devices without users even having to write a line of code. The MC0312 module has been successfully used in OEM customers' flow meter products. The customer's flow meter supports the Ethernet-APL communication interface and the HART-IP communication protocol.

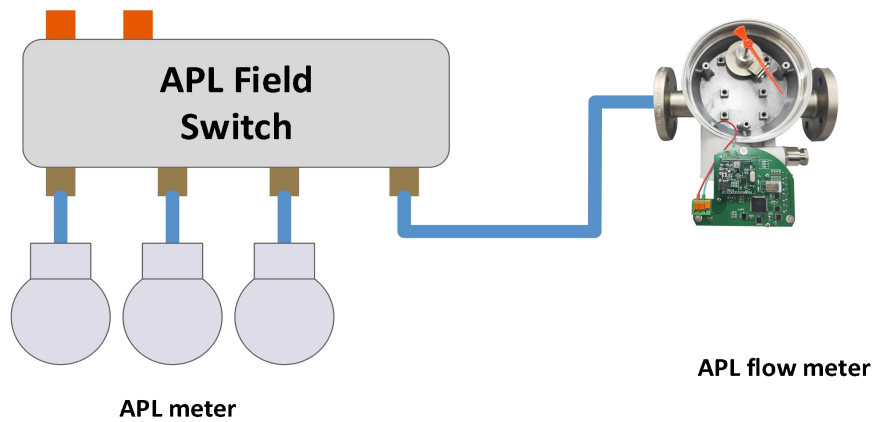

Figure 23 Application of MC0312 module on flow meter

### 5.3 Ethernet-APL Module Application Example

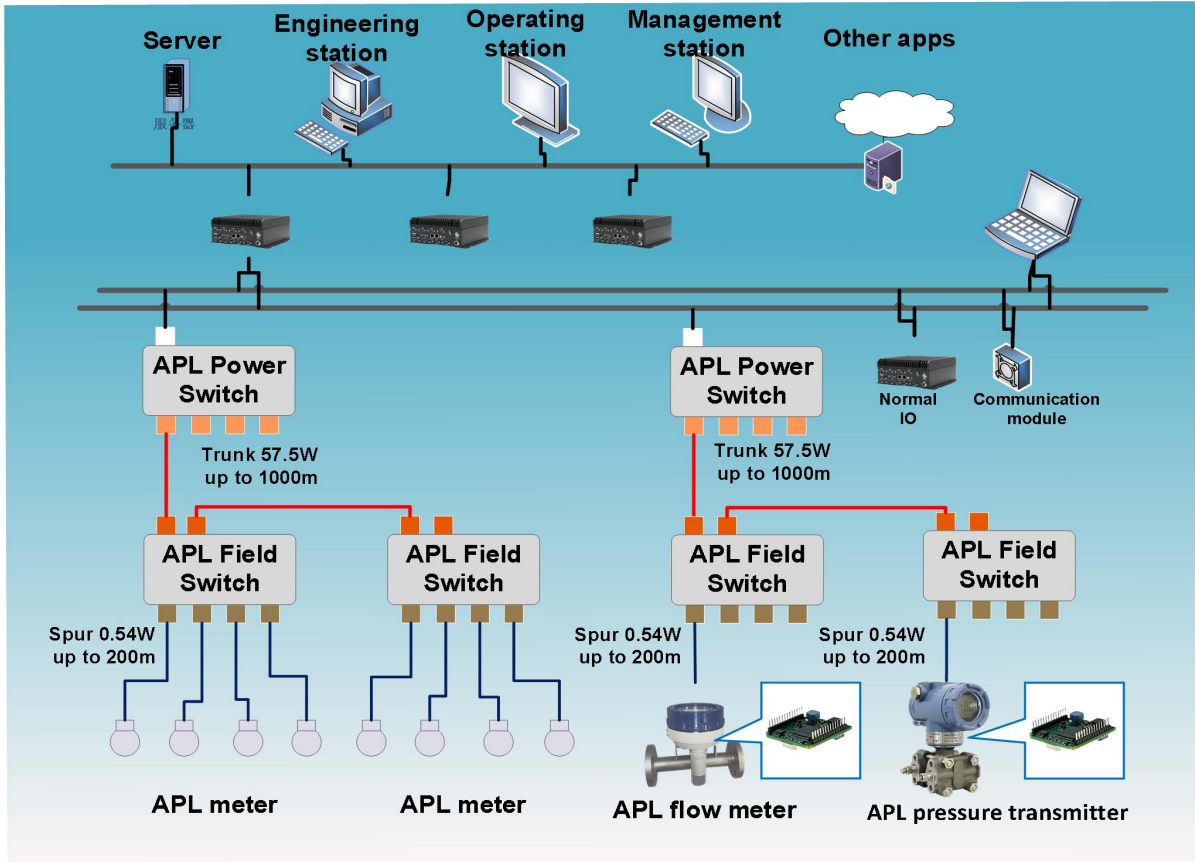

Figure 24 24 APL use case

## Chapter 6 Maintenance

- Simple maintenance

Table 4 Indicators

LED indicator light	Color	Normal status	Abnormal state	Cause of Abnormality	Correction method
HART-IP communication	Green	Blinking	OFF	No HART-IP communication	Check HART-IP host device and HART-IP interface device
				Power supply fault	Check power supply and connections
				Internal fault	Contact technical support
			ON	No HART-IP communication	Check the HART-IP host device and HART-IP interface device
				Internal fault	Contact technical support

- Routine maintenance is limited to cleaning the unit.
- Faulty maintenance: if a fault is detected, please return to the factory for repair.

## Chapter 7 Technical Specifications

### 7.1 Basic Parameters

Measurement object	Modbus RTU slave device
Bus power	14~30V
Modbus interface	TTL (supports MODBUS RTU master station communication protocol)
Isolation	No isolation between bus and Modbus interface
Bus protocol	HART-IP
Temperature range	-40°C ~ 85°C
Humidity range	5~95%RH
Start time	≤5s

### 7.2 Physical Properties

Weight	16 g
Structural materials	Coating: Polyester epoxy resin.



## MICROCYBER CORPORATION

Microcyber Corporation

<https://www.microcybers.com/>

Add: 17-8 Wensu Street, Hunnan New District, Shenyang, China 110179

Tel: 0086-24-31217278 / 31217280

Fax: 0086-24-31217293

Email: [huang.xi n@microcyber.cn](mailto:huang.xi n@microcyber.cn)