

序号/Rev.No.	名称/TITLE	文件编号/FILE No.
1	158-9P ASS'Y (GRAY HOUSING)	QJ/XYT-11241
2	158 SMALL BLASTIC BUCKLE	QJ/XYT-11237
3	158 GASKET	QJ/XYT-11204
4	158 NUT	QJ/XYT-11205
5	158SHELL FASTENING SCREWS	QJ/XYT-11206
6	158 PLASTIC CARD FASTENING SCREW	QJ/XYT-11244
7	158 SCREW (SHORT)	QJ/XYT-11209

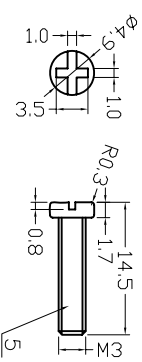
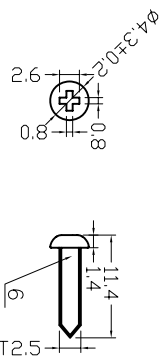
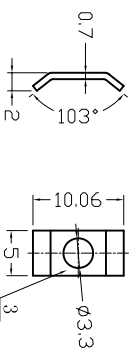
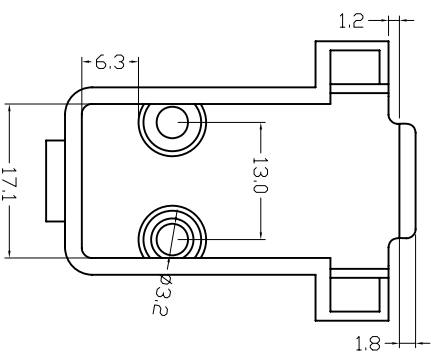
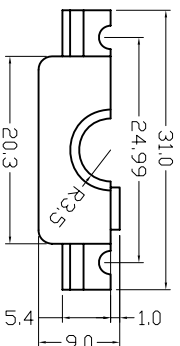
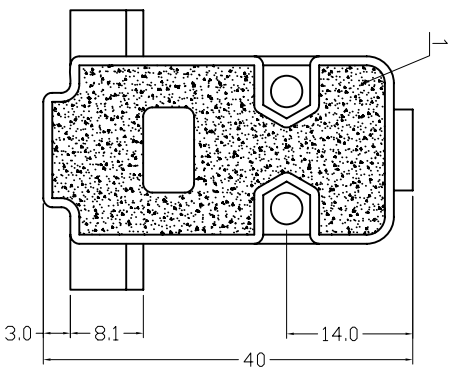
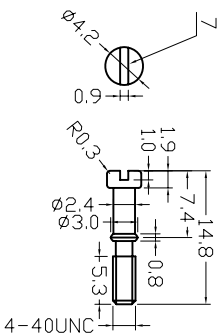
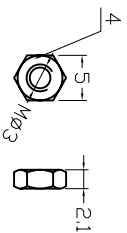
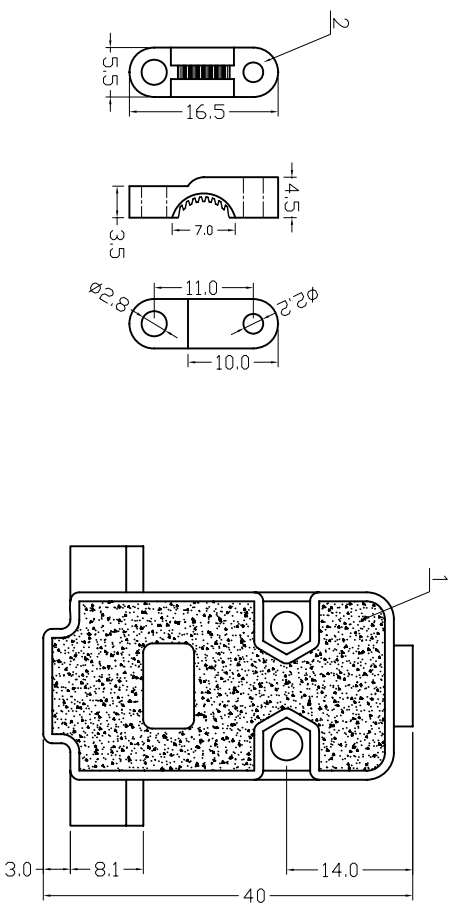

序号/Rev.No.

更改记录/revision note

签名/Signature

日期/Date

设计/Designed by

绘图/Drawing by

审核/Checked by

批准/Approved by

未注公差
General Tolerance

X ±0.2

.X ±0.1

.XX ±0.05

.XXX ±0.01

X ±0.2°

.X ±0.1°

.XX ±0.05°

.XXX ±0.01°



新莱亚电子
XINLUAYIA ELECTRONIC CO., LTD

图名/Title

文件编号/File No.

单位/Unit: mm

158-9P (Screw (short))

QJ/XYT-12162

备注/Remark

页序/Sheet

单位/Unit: mm