

辽宁博艾格电子科技有限公司

LIAONING BROTHER ELECTRONIC TECHNOLOGY CO., LTD

BIGCAP® 产品规格书

BIGCAP® PRODUCT SPECIFICATION

产品类型 (Product Type) : 卷绕系列

产品型号 (Product Model) : BRP003R0L305FB

发布日期 (Release Date) : 2021-06-10

地址: 辽宁省朝阳市龙城区高新技术园区 2 期 3 号

电话 (Phone) : 0421-7188822

传真 (Fax) : 0421-7188778

网址 (Website) : www.bigcap.net

Address: Chaoyang City, Liaoning Province, high-tech park phase 2 no.3

Phone: 0421-7188822

Fax: 0421-7188778

Website: www.bigcap.net

◆ 产品特点 Features

- 圆柱外形结构, 超低内阻
Cylindrical shape structure, ultra-low internal resistance;
- 符合 ROHS 标准, 无 Cd、Pb 等污染物质
Comply with ROHS standards no Cd Pb and other pollutants;
- 充放电循环寿命长
Long charge-discharge cycle life;
- 适合中大功率放电
Suitable for high power discharge;
- 耐压高, 达到 3.0V, 同等条件下使用高可靠性
High voltage up to 3.0V, under the same conditions with high reliability.

◆ BIGCAP® 典型应用电路 BIGCAP® Typical Application Circuit

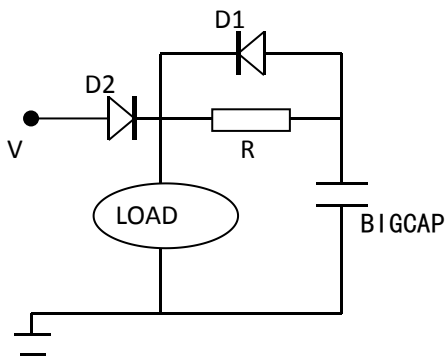

说明: 以上电路仅供参考

Description: the above circuit is for reference only.

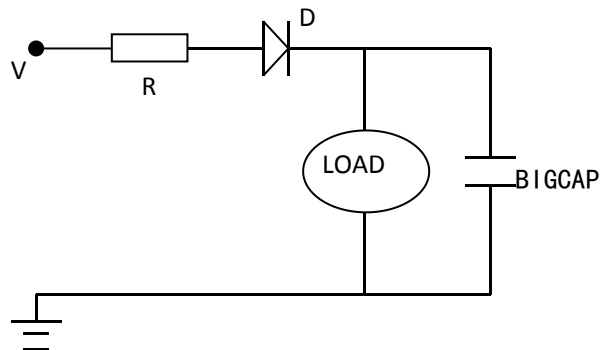

◆ BIGCAP® 标准测试条件 BIGCAP® Standard Test Conditions

本规格书标准测试条件为标准大气压, 温度25℃, 相对湿度小于60%。

The standard test conditions in this product specification are as follows: under normal pressure; the temperature at 25℃ and the relative humidity less than 60%RH.

◆ **BIGCAP® 型号命名规则 BIGCAP® Part Number System**

□ □ □

产品系列
Series

□ □ □ R □ □

额定电压
Rated Voltage

结构类型
Structure Type

□ □ □ F (□ □ □ □)

容量
Capacitance

内部控制编码
Internal Control

卷绕 PC 系列-BRE
(Winding PC series-BRE)

卷绕 AN 系列-BRP
(Winding AN series-BRP)

卷绕高比能量 AN 系列-BUP
(Winding high energy AN series-BUP)

卷绕高温系列 85℃-BRT
(Winding high temperature series-BRT)

组合 PC 系列-BME
(Combination PC series-BME)

组合 AN 系列-BMP
(Combination AN series-BMP)

组合高温系列 85℃-BMT
(Combination of high temperature series-BMT)

纽扣 PC 常规-BCE
(Button PC conventional-BCE)

纽扣高温系列 85℃-BCT
(Button high temperature series-BCT)

国网产品系列 -BGW
(State Grid products series-BGW)

MINI 系列-MINICAP
(MINI series-MINICAP)

2.7V-002R7

2.8V-002R8

5.4V-005R4

5.5V-005R5

48V-048R0

100V-100R0

200V-200R0

卷绕引线型-L

(Winding Lead Type-L)

卷绕盖板型-S/C

(Winding Snip-in Type-S/C)

卷绕螺纹型-W

(Winding Whorl Type-W)

卷绕螺柱型-B

(Winding Bolt Type-B)

卷绕多引出型-M

(Winding Multi Lead Type-M)

纽扣立式-V

(Coin V Type-V)

纽扣卧式-H

(Coin H Type-H)

纽扣 C 型-C

(Coin C Type-C)

0.047F-473

0.1F-104

0.47F-474

1.0F-105

8.0F-805

10F-106

22F-226

100F-107

360F-367

400F-407

3000F-308

◆ BIGCAP® 标识 BIGCAP® Markings

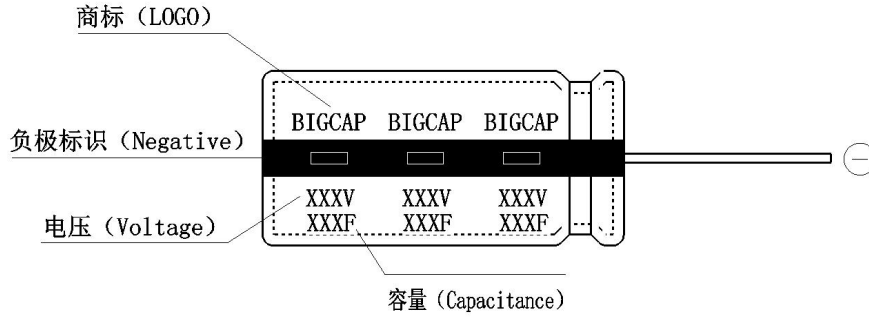

◆ BIGCAP® 标准产品外形尺寸图 BIGCAP® Shape Of Standard Product

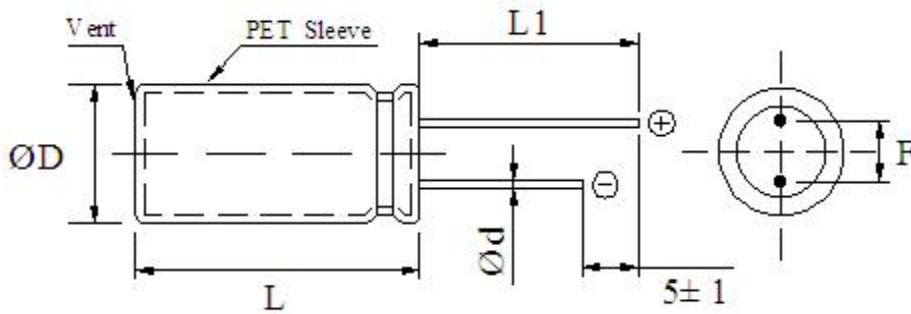

型号 Part Number	$\Phi D \pm 1.0$ (mm)	$L \pm 1.0$ (mm)	$F \pm 0.5$ (mm)	$\Phi d \pm 0.1$ (mm)	$L1 \pm 1.0$ (mm)
BRP003R0L305FB	8.0	16.0	3.5	0.6	30

◆ BIGCAP® 标准产品规格 BIGCAP® Standard Product Specification

项目 Project	BRP003R0L305FB		测试条件 Test Condition
产品依据标准 Product Standard	依据 IEC 62391-1, GB/T2693—2001, Q/BIG001—2013 测试标准 According to IEC 62391-1, GB/T2693—2001, Q/BIG001—2013 test standard		
工作温度范围 Category Temperature Range	-40°C~+65°C		
存储温度范围 (at 0V) Storage Temperature Range (at 0V)	-40°C~+70°C		
额定工作电压 (25°C) U ₀ Rated Operating Voltage (25°C) U ₀	3.0VDC		
额定容量 (25°C) Rated Capacitance (25°C)	3.0F	25°C ΔV=2.4-1.2 I=50mA	
容量允许偏差 Permitting Capacitance Error	±20%		
额定电流 (25°C) Nominal Current (25°C)	0.77A	充电至额定电压 U ₀ , 5s 放电至 1/2U ₀ Charge to rated voltage U ₀ , 5S discharge to 1/2U ₀	
最大电流 (25°C) Max Current (25°C)	3.2A	充电至额定电压 U ₀ , 1s 放电至 1/2U ₀ Charge to rated voltage U ₀ , 1S discharge to 1/2U ₀	
72h 漏电流 (25°C) Leakage Current at 72h (25°C)	<12uA		
存储能量 (at U ₀) E Max. Stored Energy (at U ₀) E	3.75mWh	$E = \frac{1/2 * CV^2}{3600} * 1000$	
质量 m Weight m	1.30g		
体积 (不含引出端子) v Volume (without terminals) v	0.8mL		
最大内阻 (ESR) The Maximum Resistance	AC@1kHz	120mΩ	
	DC	180mΩ	
能量密度 (at U ₀) Energy Density (at U ₀)	质量比 Gravimetric	2.88Wh/kg	$E_{Max} = \frac{1/2 * CV^2}{3600 * m}$ $E_{Max} = \frac{1/2 * CV^2}{3600 * v}$
	体积比 Volumetric	4.67Wh/L	
功率密度 (at U ₀) Power Density (at U ₀)	质量比 Gravimetric	9.62kW/kg	$P_{max} = \frac{V^2}{4 * ESR_{DC} * m}$ $P_{max} = \frac{V^2}{4 * ESR_{DC} * v}$
	体积比 Volumetric	15.55kW/L	

◆ **BIGCAP® 典型特性 BIGCAP® Typical Characteristics**

<p>产品依据标准</p> <p>Product Standard</p>	<p>依据 IEC 62391-1, GB/T2693—2001, Q/BIG001—2013 测试标准</p> <p>According to IEC 62391-1, GB/T2693—2001, Q/BIG001—2013 test standard</p>	
<p>温度特性</p> <p>Temperature Characteristics</p>	-40℃	<p>与初始值比较, $\Delta C/C \leq 30\%$, $ESR \leq 4$ 倍初始规定值</p> <p>Compared with the initial value, $\Delta C/C \leq 30\%$, $ESR \leq 4$ Initial specified value</p>
	+65℃	<p>与初始值比较, $\Delta C/C \leq 30\%$, $ESR \leq$ 初始规定值</p> <p>Compared with the initial value, $\Delta C/C \leq 30\%$, $ESR \leq$ Initial specified value</p>
<p>湿热特性 (at 40±2℃,90~95%RH)</p> <p>Humidity Characteristics (at 40±2℃,90~95%RH)</p>	240h	<p>与初始值比较, $\Delta C/C \leq 30\%$, $ESR \leq 2$ 倍初始规定值, 无漏液机械损伤</p> <p>Compared with the initial value, $\Delta C/C \leq 30\%$, $ESR \leq 2$ Initial specified value, no leaked electrolyte or other mechanical damage</p>
<p>高温寿命 (at U₀,65±2℃)</p> <p>High Temperature Life (at U₀,65±2℃)</p>	1000h	<p>与初始值比较, $\Delta C/C \leq 30\%$, $ESR \leq 4$ 倍初始规定值, 无漏液机械损伤</p> <p>Compared with the initial value, $\Delta C/C \leq 30\%$, $ESR \leq 4$ Initial specified value, no leaked electrolyte or other mechanical damage</p>
<p>循环寿命 (at U₀,25±2℃)</p> <p>Cycle Life (at U₀,25±2℃)</p>	500000 次	<p>Initial specified value, no leaked electrolyte or other mechanical damage</p>
<p>存放寿命 (at 0V,70±2℃)</p> <p>Shelf Life (at 0V,70±2℃)</p>	1000h	<p>与初始值比较, $\Delta C/C \leq 20\%$, $ESR \leq 3$ 倍初始规定值, 无漏液机械损伤</p> <p>Compared with the initial value, $\Delta C/C \leq 20\%$, $ESR \leq 3$ Initial specified value, no leaked electrolyte or other mechanical damage</p>
<p>自放电特性 (电压保持特性) (at 25℃)</p> <p>Self Discharge Characteristics (Voltage holding characteristics) (at 25℃)</p>	<p>正负极间电压大于等于 2.3V</p> <p>The voltage between the positive and negative electrode $\geq 2.3V$</p>	<p>充电过程: 无负载, 额定电压充电 8h</p> <p>放置过程: 相对湿度小于 60%RH, 开路放置 24h</p> <p>Charging process: normal temperature, non-loaded, charge at rated voltage for 8h</p> <p>Lay aside process: temperature less than 25℃, relative humidity less than 60%RH, lay aside 24h at open circuit</p>

◆ **BIGCAP® 特性曲线 BIGCAP® Characteristic Curve**

(1) 温度特性 Characteristics in Different Temperature

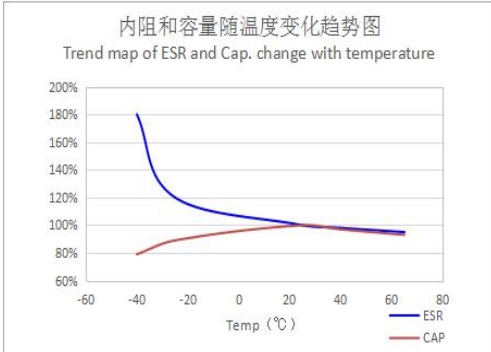

(2) 漏电流特性 LC Characteristics

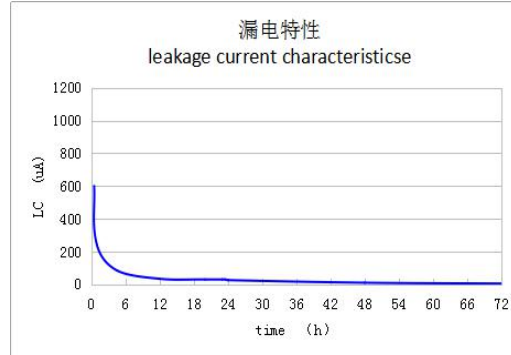

(3) 高温特性 High Temperature Life (at 3.0V, 65°C)

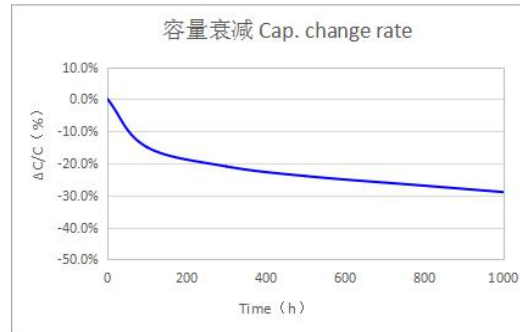
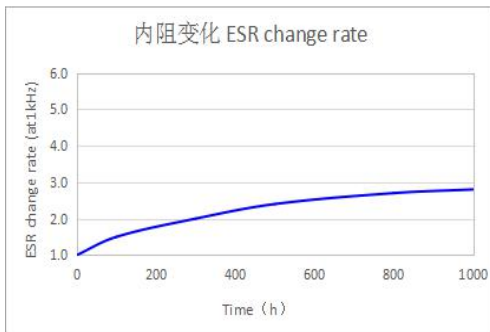

*以上特性曲线图均是趋势图，每一个型号的具体数据请与厂家技术支持联系

*The above characteristic curves are trend charts. Please contact the manufacturer's technical support for the specific data of each model.

◆ **BIGCAP® 包装规格 BIGCAP® Packing Specification**

型号 Part Number	数量(PCS) Quantity (PCS)		尺寸 (L×W×H)mm Dimension (L×W×H)mm		总重量(Kg) Total Weight (Kg)
	内箱 Inner	外箱 Outer	内箱 Inner	外箱 Outer	
BRP003R0L305FB	576	3456	260×188×95	400×290×320	6.7

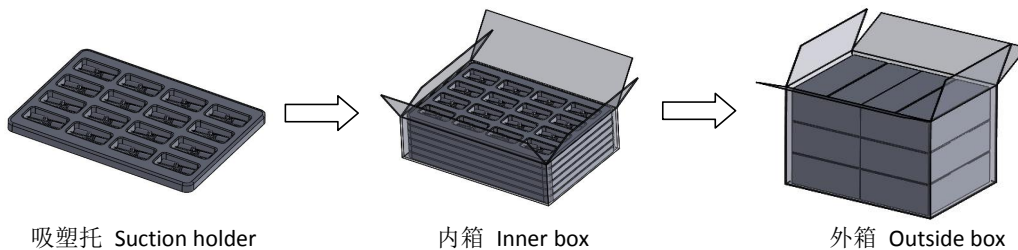

◆ **BIGCAP® 超级电容器测试方法 BIGCAP® Measuring Method Of BIGCAP**

表 1

<p>容量 (Capacitance)</p>	<p>恒流放电法测量 Constant Current Discharge of Measure</p> <ol style="list-style-type: none"> 恒流/恒压源的直流电压设定为额定电压 (U_R)。 Set the DC voltage source to the rated voltage (U_R). 设定规定的恒电流放电装置的恒定电流值。 Sets constant current values of a specified constant current discharge device. 将开关S切换到直流电源, 在恒流/恒压源达到额定电压后恒压充电30min。 Switch the switch S to DC power supply , constant voltage charge for 30min after the voltage reaches to rated voltage. 在充电30min结束后, 将开关S变换到恒流放电装置, 以恒定电流进行放电。 After charging 30min , transform the switch S to constant current discharge device to discharge at constant current. 测量电容器两端电压从U_1到U_2的时间t_1和t_2, 如图所示, 根据下列等式计算电容量值: Measure the discharge time from U_1 to U_2 (t_1、t_2), Calculate capacitance using the following formula: <div style="display: flex; justify-content: space-around; align-items: center;">   </div> $C = \frac{I \times (t_2 - t_1)}{U_1 - U_2}$
<p>内阻 (Resistance)</p>	<p>交流阻抗方法测量 Equivalent series resistance: 采用如下图所示的电路进行测量 ESR shall be measured from the circuit below:</p>  <p>电容器的内阻R_a应通过下式计算: ESR R_a can be calculated from the for $R_a = \frac{U}{I}$</p> <p>R_a 交流内阻 ($m\Omega / \Omega$) Equivalent series resistance ($m\Omega / \Omega$) ; U 交流电压有效值 (V r. m. s) U Ac voltage valid values (V r. m. s) ; I 交流电流有效值 (V r. m. s) I Ac current valid values (V r. m. s) 。</p>

表 2

<p>漏电流 (Leakage Current)</p>	<p>直流漏电流的测量原理如下 Leakage Current shall be measured from the circuit below:</p>  <p>1、放电: 该测量开始前, 电容器应进行充分放电。 Discharge: Before the start of the measurement, super-capacitor should be fully discharge .</p> <p>2、漏电流的测量应在常温 (25℃)、额定电压 (U_R) 下, 保持电容器在额定电压U_R下持续充电72h, 记录最终电流为漏电流。 Leakage current measurement shall be carried out under the temperature (25℃) and voltage rating (U_R). The capacitor is continues to charge for 72h at the rated voltage U_R, record the terminal current as leakage current .</p>
<p>自放电 (Self discharge)</p>	<p>测量开始前, 电容器应进行充分放电, 在电容器两端直接施加额定电压U_R, 不使用保护电阻, 充电时间为8h (包括电压达到施加电压95%的最大30min充电时间), 将电容器两端从电压源断开。电容器应置于标准常温常压条件下放置24h。直流电压表的内阻应大于1MΩ。</p> <p>Before the start of the measurement, super capacitor should be fully discharge. Charge the super capacitor to rated voltage without protection resistance, charging time for 8h (include the voltage of product reached 95% rated voltage after the biggest charging time for 30min). Disconnect the super capacitor from the power supply. Super capacitor should be placed in the standard atmospheric pressure conditions for 24 h. DC voltmeter internal resistance should be greater than 1 mΩ .</p> 

◆ 使用注意事项 Cautions For Use

(1) 超级电容器极性问题 The polarity of super capacitor

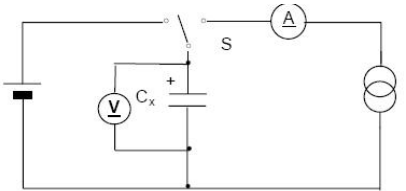
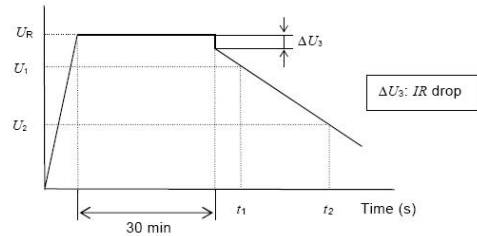
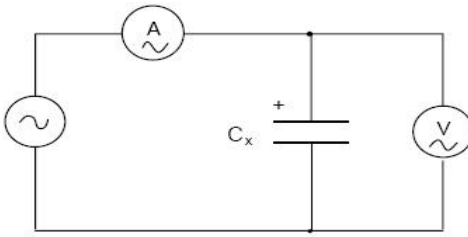
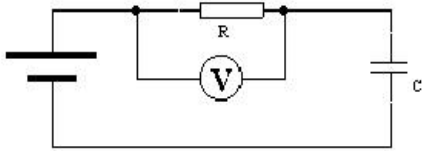
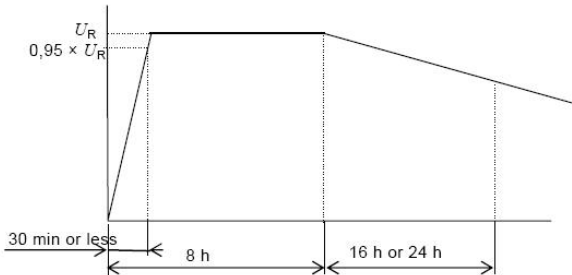
与普通电解电容器或电池不同的是, 由于超级电容器正负极采用的是同种材质, 从理论上讲是不存在极性的; 而超级电容器所标识的极性是生产商在生产工艺过程制定的, 当电容使用中不小心短期反向使用, 不会造成电容器实质性破坏, 调整为正向可保证使用, 但不可长期反向使用, 会造成电容寿命特性衰减。

Unlike ordinary electrolytic capacitor or battery, the material of positive and negative polarity of super capacitor is same, so theoretically super capacitor has no polarity; the polarities marked on super capacitor are established by manufacturers in the production process, when the polarities are used reversely in short-term, it won't cause substantial damage on capacitor, and it can be used normally after adjusting to the right polarities. But if reversely use for a long time, the life of super capacitor will decay .

(2) 关于超级电容器充电问题 Super capacitor charging information

超级电容器充电需要采用不超过额定电压的直流电压, 可采用限流、恒流、恒功率、恒电压等多种充电方式; 超级电容器充电时可能会拉低充电电源电压, 直到电容器充满维持电压平衡。

To charge a super capacitor requires DC voltage that no more than the rated voltage. It can be charged by a variety of methods such as current limit, constant current, constant power, constant voltage; when charging, the super capacitor may lower the voltage of charging power supply until the capacitor is full to maintain voltage balance.

(3) 工作电压、温度和寿命 Operating temperature and product

一般情况, BIGCAP®超级电容器在额定电压、低温条件下工作, 漏电流更小、备用时间更长、寿命更长。反之在额定电压、较高温度条件下, 则漏电流增大、备用时间缩短、寿命变短。当工作温度一定的条件下, BIGCAP®超级电容器在额定电压以下工作, 寿命会增长。

Generally, when BIGCAP® supercapacitors work at rated voltage and low temperatures, the leakage current will be less, the standby time and life will be longer. On the contrary, under the condition of rated voltage and higher temperature, the leakage current increases, the standby time is shortened, and the life is shortened. When the operating temperature is certain, the life will increase when working at the rated voltage.

(4) 安装与焊接 Installation and welding

超级电容器用于双面电路板上时, 要注意连接处不可经过电容器可触及的地方, 否则会导致产品短路过压及电容器损坏。安装过程及安装后, 不可强行扭动或倾斜电容器, 不得用力拉拽引线, 应先断针及折弯后焊接。在焊接过程中要避免使电容器过热 (1.6mm 的印刷线路板, 焊接时应为 260℃, 时间不超过 5s), 焊接后, 线路板和电容器要清洗干净。

When super capacitors are used for double-sided circuit boards, must pay attention the joint should not contact the capacitor, otherwise it will lead to short circuit, over-voltage and damage of capacitor. During the process of installation and after installation, do not twist or tilted the capacitor, do not be forcibly pull the wires. Capacitors should be welded after cutting off and bending the leads. In the welding process, pay attention to avoid overheating of the capacitor (for a 1.6 mm thickness printed circuit board, the welding temperature should be 260℃, time is not more than 5 s), circuit board and the capacitor should be clean after welding.

(5) 串联及并联使用问题 Use in series and parallel

相同超级电容器串联使用时, 总电压=串联个数×单体耐压; 总容量=单体容量÷串联个数; 总能量=串联个数×单体能量, 总内阻=串联个数×单体内阻。

三个及以上串联存在单体间的电压均衡问题, 需要考虑采用均衡电路, 用于保证长期使用过程中电容不能过电压使用, 从而引起电容器寿命衰减及损坏。客户在自行串联使用时, 建议同批次产品一起使用, 不建议不同批次产品混用。

超级电容器进行并联使用时, 可以不同容值的并联, 采用相同电压充电, 但要注意各个电容之间的电流平衡问题以及相互隔离, 避免由于放电后电势差产生的相互反向充电。

When same super capacitors used in series, the total voltage = capacitor number x capacitor voltage; the total capacitance =single capacitor capacitance /capacitor number; Total energy = capacitor number x single capacitor's energy; total resistance = capacitor number x single capacitor's resistance.

There is a voltage balance problem when 3 pcs or above capacitors used in series,so an equalization circuit is required to ensure the capacitor will not over-voltage in long term use process, as over-voltage will cause decay and damage of capacitor. When customers use the product in series by themselves, we recommend that using the same batch of products, and don't mix up different batches of products.

Super capacitors in different capacitance value can be used in parallel, theses capacitors should be charged by the same voltage, but should pay attention to the current balance problem between the capacitors and mutual isolation, to avoid potential difference happened after discharge.

(6) 规格书若有更改我司不另行通知, 我司保留可能出现的各种更改权利, 最终解释权归辽宁博艾格电子科技有限公司所有。

If there is any change in the specification without prior notice, our company reserves the right to make any possible change, and the final interpretation right belongs to liaoning brother electronic technology co., LTD.