

双联叶片泵 T6EC系列

High-pressure vane pump
T6EC Series

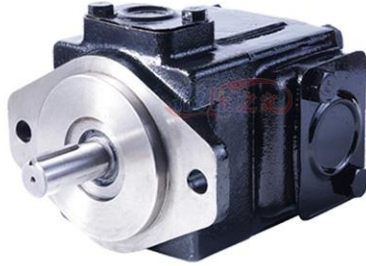

DENISON Hydraulics



How to order

01

型号说明 了解型号含义

Model notes model meaning

型号说明 Model descriptions:

T6C	-17	-1	R	00	-A	1
系列号 Code of series	排量代号 Flow code	轴伸形式 Shaft type	旋转方向 Direction of rotation	出油口位置 Outlet Positions	设计号 Designing No.	密封等级 Sealing Level
T6C	03, 05, 06, 08, 10, 12, 14, 17, 20, 22, 25, 28, 31	见轴伸尺寸 See of shaft	(从泵的轴端看) (viewed from shaft end of pump) R-顺时针旋转 R-right hand for clockwise L-逆时针旋转 L-left hand for counter clockwise	(从泵的轴端看) (viewed from shaft end of pump) 00-进油口对面 00-Opposite inlet port 01-进油口同侧 01-Inline with inlet 02-从进油口逆时针90° 90° CCW from inlet 03-从进油口顺时针90° 90° CW from inlet	A	1-S1, 丁腈橡胶 NBR Nitrile rubber 5-S5, 氟橡胶 Fluororubber
T6D	14, 17, 20, 24, 28, 31, 35, 38, 42, 45, 50, 61					
T6E	42, 45, 50, 52, 57, 62, 66, 72, 85					

Specifications

02

商品规格 品质有保证

Commodity specifications and quality guaranteed

技术参数 Technical parameters

系列号 series	排量代号 Flow code (USgpm)	理论排量 Geometric displacement mL/r	最高压力 Max. pressure Mpa						最高转速 Max. speed r/min		最低转速 Min. speed r/min
			抗磨液压油 Antiwear hydraulic oil		普通液压油和磷酸酯油 General hydraulic oil or phosphate ester fluid		水乙二醇和油包水乳化液 Water glycol fluid or water-oil emulsions		普通液压油和抗磨液压油 General hydraulic oil or antiwear hydraulic oil	水乙二醇、磷酸酯油和油包水乳化液 Water glycol fluid or phosphate ester fluid or water-oil emulsions	
			间歇 Instant	连续 Continuous	间歇 Instant	连续 Continuous	间歇 Instant	连续 Continuous			
T6E	42	132.3	24.5	21	21	17.5	17.5	14	2200	1800	600
	45	142.4									
	50	158.5									
	52	164.8									
	57	179.8									
	62	196.7									
	66	213.3									
72	227.1										
	85	269.0	9	7.5	7.5	7.5	7.5	7.5	2000		

安装尺寸图 让安装更省心

Installation size figure let more worry

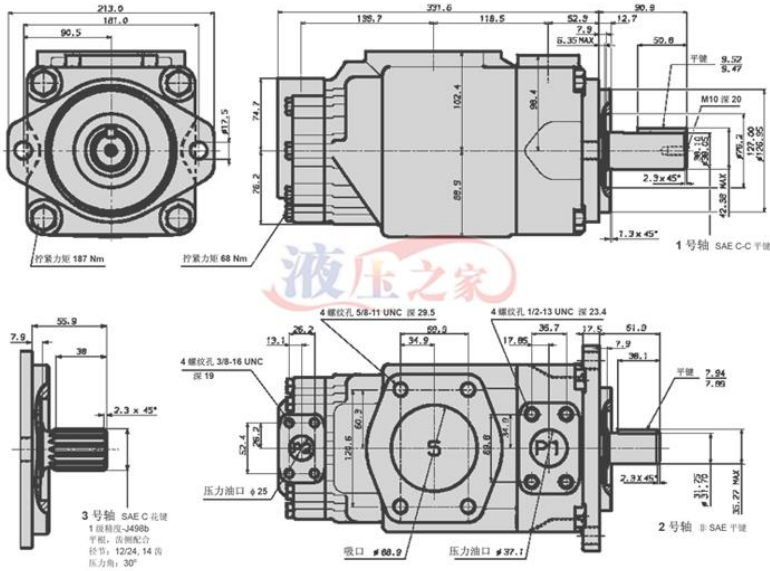

性能曲线图 让效率不再低

Performance curves for higher efficiency

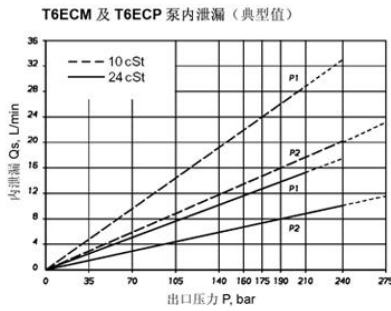
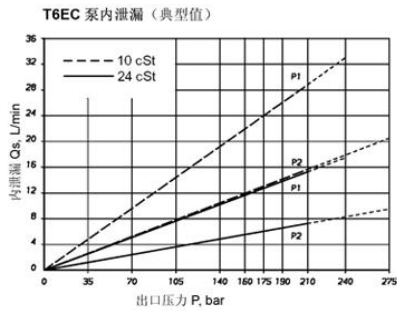

注: 在任何转速或粘度下, 若泵的任一联的内泄漏超过理论流量的 50%, 则泵的运转持续时间不得超过 5 s。
总泄漏量为各联内泄漏之和。

注: 在任何转速或粘度下, 若泵的任一联的内泄漏超过理论流量的 50%, 则泵的运转持续时间不得超过 5 s。
总泄漏量为各联内泄漏之和。

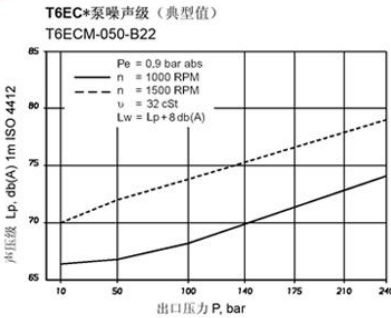
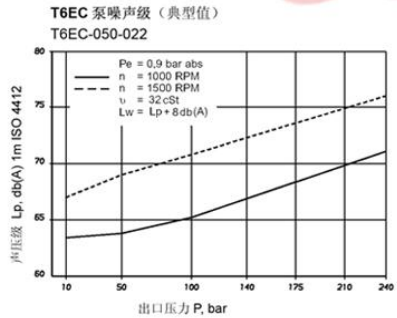

Details

05

细节展示 全方位俘获你的心

Details to show the omni-directional capture your heart

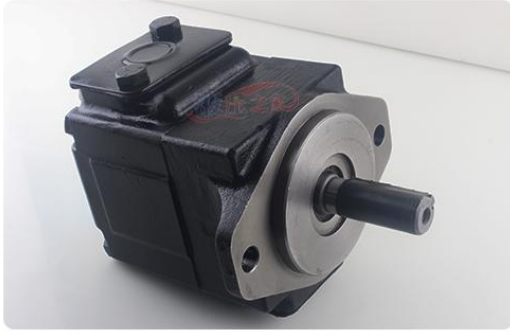

1

正面展示

2

右侧展示



3

左侧展示



4

背面展示

