

COPYRIGHT

企业保留更改产品设计与规格的权利、届时恕不另行通知。所有资料经过小心核对、以求准确，如果有任何印刷错误或在制作中可能产生之误差，本公司不承担因此产生之后果。印刷过程可能令资料内的产品跟实物有轻微分别，选择产品均以实物为准。

Preserves the right to change the product design and specifications without notice All information is carefully checked for accuracy. We shall not be accountable for damages caused by any possible faults or errors in the printing and publishing process Your choice of product shall be made against the material object as the product picture may have slight difference with the material object the printing process.

想象力设计摄影 1372727831

AGODA® 亚高达®

**PROFESSIONAL
HARDWARE MANUFACTURER**

专业五金制造商



网站/WEB



电子画册/e-magazine

广东雅高达金属制品有限公司

GUANGDONG YAGAODA METAL PRODUCTS CO., LTD

电话/TEL: +86 136 6096 7390 +86 136 6097 8151 +86 0758 8539636

邮箱/E-mail: agodahardware@163.com

网站/web address: www.agodahardware.com

地址: 广东省肇庆市金利高新区新中心城区

Address / add: New central urban area of Jinli high tech Zone, Zhaoqing City, Guangdong Province

AGODA® 亚高达®



AGODA

广东雅高达金属制品有限公司

GUANGDONG YAGAODA METAL PRODUCTS CO., LTD

**PROFESSIONAL
HARDWARE MANUFACTURER**

专业五金制造商



PROFESSIONAL
HARDWARE MANUFACTURER

专业五金制造商

GUANGDONG YAGAODA METAL PRODUCTS CO., LTD
广东雅高达金属制品有限公司

COMP ANYPROFILE

企业简介

广东雅高达金属制品有限公司是一家专业生产家居五金等产品专业生产制造商。拥有先进、高效、严谨的管理模式，是一家集研发、生产、营销为一体的五金企业。

五金依靠先进的生产技术和强大的研发实力，在使用功能上不断创新，导入极具现代感的外型设计，使产品具有极佳的实用性,靓丽的外形使之成为生活中的一大亮点。

雅高达品质、服务、诚信是一贯坚持和宗旨，坚定奉行“质量为企业生存之本”的理念。积极的参与，理性的责任感，是企业赖以生存之本的原动力；以科学为手段，以任性为依据，以艺术为品味，追求产品与环境的融合，是雅高达品牌的魅力所在;精益求精，与时俱进，造福人群，是企业为之努力不懈的目标。

立足现在，展望未来，雅高达将不断前进，，我们热烈欢迎国外客商与我们携手共创未来!

Guangdong yagaoda metal products Co., Ltd is a professional manufacturer of household hardware and other products. With advanced, efficient and rigorous management mode, it is A hardware enterprise integrating R & D, production and marketing.

Relying on advanced production technology and strong R & D strength, hardware continues to innovate in use functions, and introduces highly modern appearance design to make the products extremely attractive Good practicality and beautiful appearance make it a highlight in life.

Yagaoda has always adhered to the principle of quality, service and integrity, and firmly pursues the concept of "quality is the foundation of enterprise survival". Active participation and rational responsibility Sense is the driving force for the survival of enterprises; taking science as the means, willfulness as the basis, art as the taste, and pursuing the integration of products and environment is Yagoda The charm of the brand; Keeping improving, keeping pace with the times and benefiting the people are the unremitting goal of the enterprise.

Based on the present and looking forward to the future, accorcion will continue to move forward. We warmly we lcome foreign merchants to join hands with us to create the future!

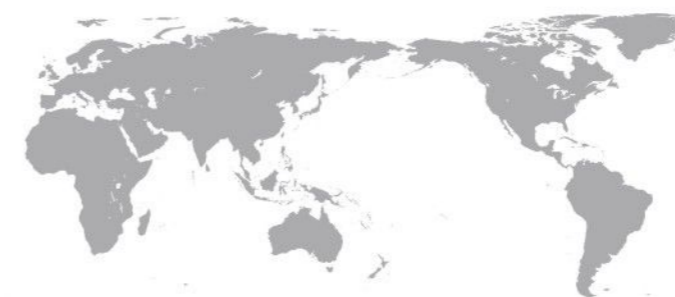

PERFECT QUALITY ASSURANCE

完美的品质保障

COMPREHENSIVE SALES CONSULTING

全面的销售咨询

PERFECT AFTER-SALES SERVICE

完美的售后服务

No. YGD-117 衣柜拉直器
 WARDROBE DOOR STRAIGHTENER

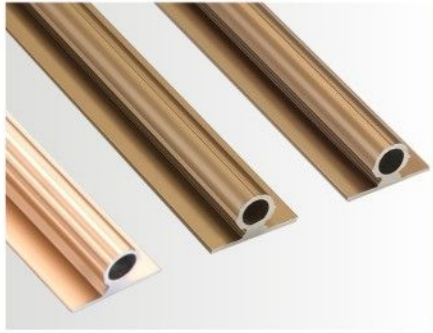

产品材质：铝
 Material: aluminium
 表面处理：拉丝、光铬、喷涂
 Finishing: drawing/chrome mirror/spraying



No. YGD-118 衣柜拉直器 (普通款)
 WARDROBE DOOR STRAIGHTENER (ORDINARY)

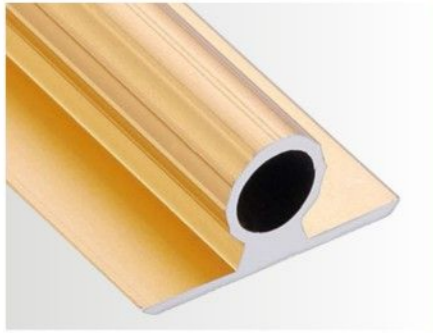

产品材质：铝
 Material: aluminium
 表面处理：拉丝、光铬、喷涂
 Finishing: drawing/chrome mirror/spraying



No. YGD-119 衣柜拉直器 (威法款)
 WARDROBE DOOR STRAIGHTENER (VEFA)



产品材质：铝
 Material: aluminium
 表面处理：拉丝、光铬、喷涂
 Finishing: drawing/chrome mirror/spraying



衣柜拉直器参数 WARDROBE DOOR STRAIGHTENER PARAMETER

名称 Product Name	颜色 Color	长度 (m) Length (m)	箱/数量 (支) Box/Quantity (Pieces)	衣柜门板厚度 Wardrobe door thickness	体积 Volume	重量 (kg) Weight (kg)	尾端可裁 (cm) Tail can be cut (cm)
威法款 VEFA	威法金 VEFA gold	2.78	30	18-25mm	2.80 × 15.5 × 6	36	40
		2.44	30	18-25mm	2.46 × 15.5 × 6	31.5	35
		2.1	30	18-25mm	2.12 × 15.5 × 6	27.3	30
		1.8	30	18-25mm	1.82 × 15.5 × 6	23	30
		1.5	30	18-25mm	1.52 × 15.5 × 6	19.3	30
普通款 ORDINARY	玫瑰金 rose gold	2.78	30	16-20mm	2.80 × 15.5 × 6	27.3	30
		2.44	30	16-20mm	2.46 × 15.5 × 6	34	25
		2.1	30	16-20mm	2.12 × 15.5 × 6	20.6	20
		1.8	30	16-20mm	1.82 × 15.5 × 6	17.4	20
		1.5	30	16-20mm	1.52 × 15.5 × 6	14.3	20

No. YGD-004 重型吊轮
 HEAVY LIFTING WHEEL



No. YGD-121 重型吊轮
 HEAVY LIFTING WHEEL



No. YGD-122 重型吊轮
 HEAVY LIFTING WHEEL



No. YGD-123 重型吊轮
 HEAVY LIFTING WHEEL



No. YGD-124 重型吊轮
 HEAVY LIFTING WHEEL



No. YGD-125 重型吊轮
 HEAVY LIFTING WHEEL



No. YGD-126 重型吊轮
 HEAVY LIFTING WHEEL



No. YGD-127

气动支撑杆
GAS SPRING



产品材质: 铜/铝/阻尼塑料 Product material: copper / aluminum / damping plastic
承重范围: 10-400N Bearing range: 10-400n
处理工艺: 电镀/喷涂 Treatment process: electroplating / spraying

No. YGD-128

气动支撑杆
GAS SPRING



产品材质: 铜/铝/阻尼塑料 Product material: copper / aluminum / damping plastic
承重范围: 10-400N Bearing range: 10-400n
处理工艺: 电镀/喷涂 Treatment process: electroplating / spraying

No. YGD-133

气动支撑杆
GAS SPRING



产品材质: 铜/铝/阻尼塑料 Product material: copper / aluminum / damping plastic
承重范围: 10-400N Bearing range: 10-400n
处理工艺: 电镀/喷涂 Treatment process: electroplating / spraying

No. YGD-134

气动支撑杆
GAS SPRING



产品材质: 铜/铝/阻尼塑料 Product material: copper / aluminum / damping plastic
承重范围: 10-400N Bearing range: 10-400n
处理工艺: 电镀/喷涂 Treatment process: electroplating / spraying

No. YGD-129

气动支撑杆
GAS SPRING



产品材质: 铜/铝/阻尼塑料 Product material: copper / aluminum / damping plastic
承重范围: 10-400N Bearing range: 10-400n
处理工艺: 电镀/喷涂 Treatment process: electroplating / spraying

No. YGD-130

气动支撑杆
GAS SPRING



产品材质: 铜/铝/阻尼塑料 Product material: copper / aluminum / damping plastic
承重范围: 10-400N Bearing range: 10-400n
处理工艺: 电镀/喷涂 Treatment process: electroplating / spraying

No. YGD-135

气动支撑杆
GAS SPRING



产品材质: 铜/铝/阻尼塑料 Product material: copper / aluminum / damping plastic
承重范围: 10-400N Bearing range: 10-400n
处理工艺: 电镀/喷涂 Treatment process: electroplating / spraying

No. YGD-136

气动支撑杆
GAS SPRING



产品材质: 铜/铝/阻尼塑料 Product material: copper / aluminum / damping plastic
承重范围: 10-400N Bearing range: 10-400n
处理工艺: 电镀/喷涂 Treatment process: electroplating / spraying

No. YGD-131

气动支撑杆
GAS SPRING



产品材质: 铜/铝/阻尼塑料 Product material: copper / aluminum / damping plastic
承重范围: 10-400N Bearing range: 10-400n
处理工艺: 电镀/喷涂 Treatment process: electroplating / spraying

No. YGD-132

气动支撑杆
GAS SPRING



产品材质: 铜/铝/阻尼塑料 Product material: copper / aluminum / damping plastic
承重范围: 10-400N Bearing range: 10-400n
处理工艺: 电镀/喷涂 Treatment process: electroplating / spraying

No. YGD-137

气动支撑杆
GAS SPRING



产品材质: 铜/铝/阻尼塑料 Product material: copper / aluminum / damping plastic
承重范围: 10-400N Bearing range: 10-400n
处理工艺: 电镀/喷涂 Treatment process: electroplating / spraying

No. YGD-138

气动支撑杆
GAS SPRING



产品材质: 铜/铝/阻尼塑料 Product material: copper / aluminum / damping plastic
承重范围: 10-400N Bearing range: 10-400n
处理工艺: 电镀/喷涂 Treatment process: electroplating / spraying



床上应用
Bed application

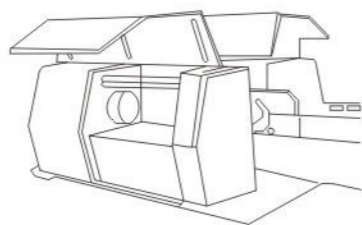

机床上应用
Application on machine tool

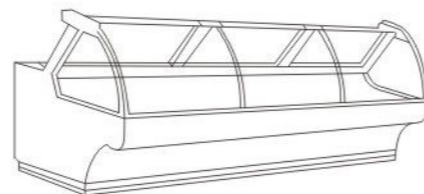

超市冷柜上应用
Application in freezer

气动支撑
PNEUMATIC SUPPORT SERIES

*适用于汽车引擎盖、后门的开启, 绘图机、航空货架、印刷机械、食品加工机及现代自动化的机械设备, 健身器材、纺织、电脑家具、木工机械等。

*举力规格: 200-900N
*表面处理: 电镀、喷涂

*Adapted for the car hood, the back door open, drawing machine, aviation rack, printing machinery, Food processing machine and the modern automated machinery and equipment, fitness equipment, textiles, computer furniture, wood working machinery

*Lifting force specification :200-900N
*Surface treatment: electroplating, spray



No. YGD-139

小拉手
Cabinet Handle



产品材质: 不锈钢
Material: stainless steel
表面处理: 拉丝
Finishing: drawing
颜色: 银色、钛金、喷粉黑
Color: Silver/titanium/dusting black
孔距/Hole spacing: 64/96/128/160/192/224/320mm



No. YGD-140

小拉手
Cabinet Handle



产品材质: 不锈钢
Material: stainless steel
表面处理: 拉丝
Finishing: drawing
颜色: 银色、钛金、喷粉黑、玫瑰金
Color: Silver/titanium/dusting black/rose gold
孔距/Hole spacing: 64/96/128/160/192/224/320mm

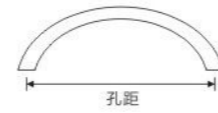

No. YGD-0145

小拉手
Cabinet Handle



产品材质: 不锈钢
Material: stainless steel
表面处理: 拉丝
Finishing: drawing
颜色: 银色、钛金、喷粉黑、玫瑰金
Color: Silver/titanium/dusting black/rose gold
孔距/Hole spacing: 64/96/128/160/192/224/320mm

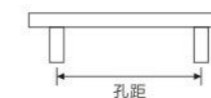

No. YGD-146

小拉手
Cabinet Handle



产品材质: 铝合金
Material: aluminium alloy
表面处理: 拉丝
Finishing: drawing
颜色: 银色、金色、灰色
Color: Silver/Gold/Gray
孔距/Hole spacing: 64/96/128/160/192/224/320mm



No. YGD-141

小拉手
Cabinet Handle



产品材质: 不锈钢
Material: stainless steel
表面处理: 拉丝
Finishing: drawing
颜色: 银色、钛金、喷粉黑
Color: Silver/titanium/dusting black
孔距/Hole spacing: 64/96/128/160/192/224/320mm



No. YGD-142

小拉手
Cabinet Handle



产品材质: 不锈钢
Material: stainless steel
表面处理: 拉丝
Finishing: drawing
颜色: 银色、钛金、喷粉黑、玫瑰金
Color: Silver/titanium/dusting black/rose gold
孔距/Hole spacing: 64/96/128/160/192/224/320mm



No. YGD-147

小拉手
Cabinet Handle



产品材质: 不锈钢
Material: stainless steel
表面处理: 拉丝
Finishing: drawing
颜色: 银色、钛金、喷粉黑、玫瑰金
Color: Silver/titanium/dusting black/rose gold
孔距/Hole spacing: 64/96/128/160/192/224/320mm

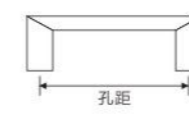

No. YGD-148

小拉手
Cabinet Handle



产品材质: 不锈钢
Material: stainless steel
表面处理: 拉丝
Finishing: drawing
颜色: 银色、钛金、喷粉黑、玫瑰金
Color: Silver/titanium/dusting black/rose gold
孔距/Hole spacing: 64/96/128/160/192/224/320mm



No. YGD-143

小拉手
Cabinet Handle



产品材质: 不锈钢+锌合金
Material: stainless steel
表面处理: 拉丝
Finishing: drawing
颜色: 银色、钛金、喷粉黑
Color: Silver/titanium/dusting black
孔距/Hole spacing: 64/96/128/160/192/224/320mm

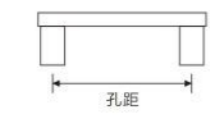

No. YGD-144

小拉手
Cabinet Handle



产品材质: 不锈钢
Material: stainless steel
表面处理: 拉丝
Finishing: drawing
颜色: 银色、钛金、喷粉黑、玫瑰金
Color: Silver/titanium/dusting black/rose gold
孔距/Hole spacing: 64/96/128/160/192/224/320mm



No. **YGD-149**
暗拉手 Cabinet handle



产品材质：不锈钢
Material: stainless steel

No. **YGD-150**
暗拉手 Cabinet handle



产品材质：不锈钢
Material: stainless steel

No. **YGD-152**
暗拉手 Cabinet handle



产品材质：不锈钢
Material: stainless steel

No. **YGD-153**
暗拉手 Cabinet handle



产品材质：不锈钢
Material: stainless steel

No. **YGD-154**
暗拉手 Cabinet handle



产品材质：不锈钢
Material: stainless steel

No. **YGD-155**
暗拉手 Cabinet handle



产品材质：不锈钢
Material: stainless steel

No. **YGD-156**
暗拉手 Cabinet handle



产品材质：不锈钢
Material: stainless steel

No. **YGD-158**
暗拉手 Cabinet handle



产品材质：不锈钢
Material: stainless steel

No. **YGD-159** 沙发脚 SOFALEGS



产品材质：铝合金
Material: Aluminum alloy
表面处理：喷砂、哑光、光铬、香槟金
Surface treatment: Sandblasted, Matte, Light Chrome, Champagne Gold
产品规格：φ50 (H50-200mm)
Specification: φ50 (H50-200mm)

No. **YGD-160** 沙发脚 SOFALEGS

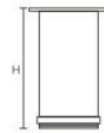

产品材质：不锈钢/铁
Material: stainless steel/iron
表面处理：光铬、拉丝、喷涂
Surface treatment: Light chrome, brushed, sprayed
产品规格：φ50 (H60-200mm)
Specification: φ50 (H60-200mm)

No. **YGD-161** 沙发脚 SOFALEGS



产品材质：铁
Material: Iron
表面处理：光铬、拉丝、喷涂
Surface treatment: Light chrome, brushed, sprayed
产品规格：φ32 (H150/120/100mm)
Specification: φ32 (H150/120/100mm)

No. **YGD-162** 沙发脚 SOFALEGS

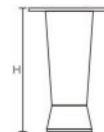

产品材质：锌合金
Material: Zinc alloy
表面处理：光铬、拉丝、喷涂
Surface treatment: Light chrome, brushed, sprayed
产品规格：H80/100mm
Specification: H80/100mm

No. **YGD-163** 沙发脚 SOFALEGS



产品材质：铁
Material: iron
表面处理：光铬、拉丝、喷涂
Surface treatment: Light chrome, brushed, sprayed
产品规格：φ50 (H50-200mm)
Specification: φ50 (H50-200mm)

No. **YGD-165** 沙发脚 SOFALEGS

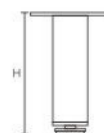

产品材质：铁
Material: iron
表面处理：光铬、拉丝、喷涂
Surface treatment: Light chrome, brushed, sprayed
产品规格：φ30 (H60-200mm)
Specification: φ30 (H60-200mm)

No. **YGD-166** 沙发脚 SOFALEGS



产品材质：铝合金
Material: Aluminum alloy
表面处理：喷砂、哑光、光铬、香槟金
Surface treatment: Sandblasted, Matte, Light Chrome, Champagne Gold
产品规格：40×40 (H60-200mm)
Specification: 40×40 (H60-200mm)



No. **YGD-168** 沙发脚 SOFALEGS



产品材质：铁
Material: iron
表面处理：光铬、拉丝、喷涂
Surface treatment: Light chrome, brushed, sprayed
产品规格：φ50 (H60-200mm)
Specification: φ50 (H60-200mm)

No. **YGD-169** 沙发脚 SOFALEGS



产品材质：铁
Material: iron
表面处理：光铬、拉丝、喷涂
Surface treatment: Light chrome, brushed, sprayed
产品规格：φ30 (H60-200mm)
Specification: φ30 (H60-200mm)

No. **YGD-175** 沙发脚 SOFALEGS



产品材质：铝合金
Material: Aluminum alloy
表面处理：喷砂、哑光、光铬、香槟金
Surface treatment: Sandblasted, Matte, Light Chrome, Champagne Gold
产品规格：38×38 (H60-200mm)
Specification: 38×38 (H60-200mm)

No. **YGD-176** 沙发脚 SOFALEGS



产品材质：铁
Material: iron
表面处理：光铬、拉丝、喷涂
Surface treatment: Light chrome, brushed, sprayed
产品规格：φ50 (H60-200mm)
Specification: φ50 (H60-200mm)

No. **YGD-171** 沙发脚 SOFALEGS

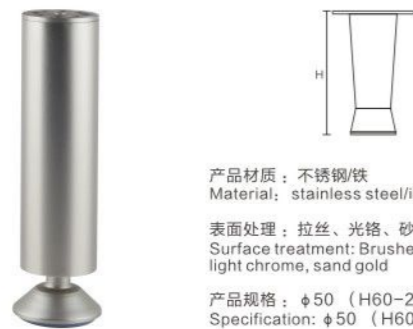

产品材质：不锈钢/铁
Material: stainless steel/iron
表面处理：拉丝、光铬、砂金
Surface treatment: Brushed, light chrome, sand gold
产品规格：φ50 (H60-200mm)
Specification: φ50 (H60-200mm)

No. **YGD-172** 沙发脚 SOFALEGS



产品材质：铁
Material: iron
表面处理：光铬、拉丝、喷涂
Surface treatment: Light chrome, brushed, sprayed
产品规格：φ25 (H150/120/100mm)
Specification: φ25 (H150/120/100mm)

No. **YGD-177** 沙发脚 SOFALEGS



产品材质：铝合金
Material: Aluminum alloy
表面处理：喷砂、哑光、光铬、香槟金
Surface treatment: Sandblasted, Matte, Light Chrome, Champagne Gold
产品规格：38×38 (H100-180mm)
Specification: 38×38 (H100-180mm)

No. **YGD-178** 吧台支撑 BAR SUPPORT



面板材质：铝合金
Material: Aluminum alloy
管材质：不锈钢/铁
Material: stainless steel/iron
表面处理：光铬
Surface treatment: Chrome

No. **YGD-173** 沙发脚 SOFALEGS



产品材质：铝合金
Material: Aluminum alloy
表面处理：喷砂、哑光、光铬、香槟金
Surface treatment: Sandblasted, Matte, Light Chrome, Champagne Gold
产品规格：φ50 (H60-200mm)
Specification: φ50 (H60-200mm)

No. **YGD-174** 沙发脚 SOFALEGS



产品材质：铝合金
Material: Aluminum alloy
表面处理：喷砂、哑光、光铬、香槟金
Surface treatment: Sandblasted, Matte, Light Chrome, Champagne Gold
产品规格：40×40 (H60-200mm)
Specification: 40×40 (H60-200mm)

No. **YGD-180** 沙发脚 SOFALEGS



产品材质：铁
Material: iron
表面处理：光铬、拉丝、喷涂
Surface treatment: Light chrome, brushed, sprayed
产品规格：30×30×150×150mm
25×25×200×200mm
Specification: 30×30×150×150mm
25×25×200×200mm

No. **YGD-181** 沙发脚 SOFALEGS



产品材质：铁
Material: iron
表面处理：光铬、拉丝、喷涂
Surface treatment: Light chrome, brushed, sprayed
产品规格：H100
Specification: H100



No. **YGD-182** 沙发脚 SOFALEGS



产品材质：铁
Material: iron
表面处理：光铬、拉丝、喷涂
Surface treatment: Light chrome, brushed, sprayed
产品规格：H130
Specification: H130

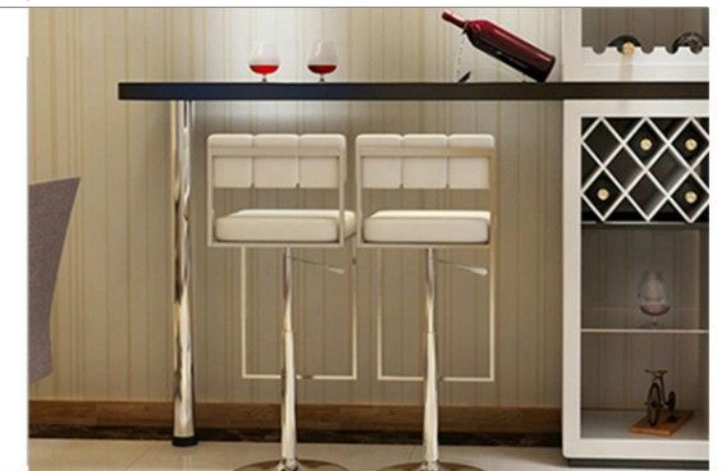

No. **YGD-183** 沙发脚 SOFALEGS



No. **YGD-184** 沙发脚 SOFALEGS



No. **YGD-191** 沙发脚 SOFALEGS



No. **YGD-192** 沙发脚 SOFALEGS



No. **YGD-185** 沙发脚 SOFALEGS



No. **YGD-186** 沙发脚 SOFALEGS



No. **YGD-193** 沙发脚 SOFALEGS



No. **YGD-194** 沙发脚 SOFALEGS



No. **YGD-187** 沙发脚 SOFALEGS



No. **YGD-189** 沙发脚 SOFALEGS

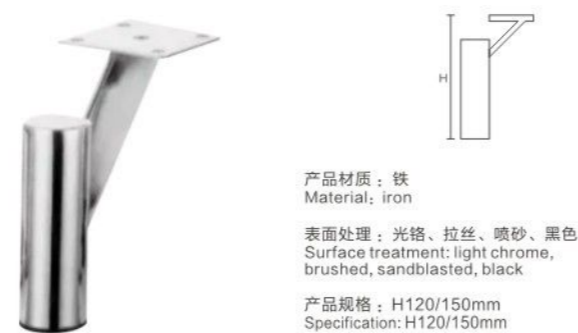

No. **YGD-195** 沙发脚 SOFALEGS



No. **YGD-196** 沙发脚 SOFALEGS



No. **YGD-190** 沙发脚 SOFALEGS



No. **YGD-197** 沙发脚 SOFALEGS

