



**Maximum Safety in Surge Protection**



# Surge Protective Devices (SPDs)



[www.ProSurge.com](http://www.ProSurge.com)  
2025 Edition







Prosurge Electronics Co., Ltd - Foshan, China

Prosurge is a globally competitive surge protection company and is one of the fastest growing companies in this industry.

We start from a humble beginning by a group of experts. For the past 20 years, we extended our business in 6 continents and more than 60 countries. Although United States still remains our biggest single market, most of our revenue comes from international market.

Our mission is to protect millions of businesses, households and organizations from lightning & surge damages. Inspired and encouraged by this mission, we are doing things differently than many of our competitors.

We innovate. As an engineering driven company, we invest a way-above-average ratio of yearly revenue on R&D. This ensures Prosurge to be among the very few companies who can offer the most complete SPDs on both UL and IEC standards markets.

We challenge. Using our ingenuity, we are raising the standards for SPD quality & reliability via designing, manufacturing and testing. Our

SPD is one of the safest on the market.

We collaborate. The Prosurge team is one of the best in industry. We share the same value: pursue excellence in everything we do. Together, we are delivering world-class products and solutions.

We progress. Despite our accomplishment, We deem ourselves progressive instead of successful. With a continuous improving mentality, we are always bettering than we used to be.

We support. Our customers are supported and well-served in various ways: 2-hour response, technical training, video conference, regular visit, well-documented material ect. In fact, they are so loyal and satisfied that they are happy to write recommendation letters for us.

Trust us with confidence. Stay safe and sound with Prosurge!

## Team



**Bill Goldbach**

Bill has been recognized as a leading industry expert in Power Engineering and Surge Protective Devices. He used to be member of IEEE' standards board and UL1449 STP.



**Terry Mao**

Terry has been in surge protection industry for about 20 years. He has in-depth experience and expertise spanning from MOV to SPD. He is the member of UL1449 STP.



**Product Approvals & Standards:**

- UL, ETL (ANSI/UL 1449 5th edition, CSA C22.2, UL 497b, etc.)
- KEMA, TUV (EN/IEC 61643-1/11, IEC 61643-31, EN50539-11)
- CE (LVD, EMC)



**R&D**

- International R&D team with China & USA experts, senior member of IEC, UL and IEEE.
- Main products are international patents protected to avoid any possible intellectual property risk



**Production Capacity**

- Factory size in square meter: 4000
- More than monthly 300K pcs SPDs in one shift

**Strict Bar Code Management Tracking System**

- Bar code management for each part to trace lot #, parameters, materials lot No., materials specification, key process operator etc.



**Prosurge's In-house Lab**

- Prosurge can perform testing according to ANSI/UL 1449, 497a/b/c, EN/IEC 61643-1/11/31, EN 50539-11, EN60730-1, EN/IEC 61643-21, IEEE C62.41 etc. at PROSURGE in-house Lab
- China's leading Lightning Protection test laboratory
- Strictly follow ISO/IEC 17025 Testing and Calibration Laboratories standards
- TÜV SÜD External Test Laboratory (ETL)



**Quality Assurance**

- Global supplier of Fortune 500 enterprises
- ISO 9001 certified Quality Management System
- ISO 14001 certified Environmental Management System
- ISO 45001 certified Occupational Health Safety Management System
- 6 Sigma Quality Control System
- Inspection by 100% before packing
- 5+ Years Warranty







**Multi-waveform Surge Generator**

- For IEC/EN 61643 Type1, 2, 3 / Class B, C,D SPD, and UL1449 all type testing
- Current capacity: 100kA (10/350µs), 150kA (8/20µs) & combination wave (1.2/50µs voltage - 8/20µs current)

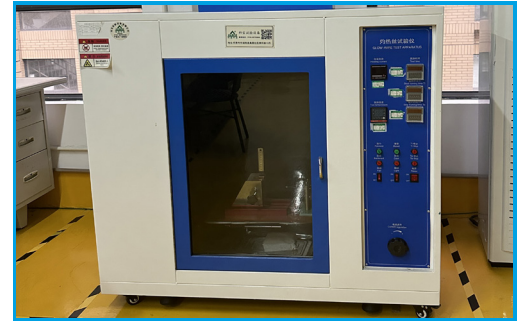

**Glow Wire Tester**

- IEC/EN 61643 Resistance to abnormal heat and fire



**Online Aging Tester**

- Uc / MCOV compliance 100% online testing before packing



**Environment Test Chamber**

- UL, EN/IEC Environment test, Aging test



**Rated Functioning Temperature (Tf)**

- UL60691 & IEC60691

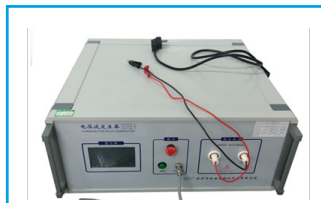

**1.2/50 Voltage Impulse Generator**

- UL 1449 & IEC/EN61643

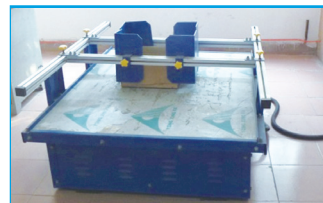

**Vibration Tester**

- Structural & packaging test



**Thermal Stability Tester**

- IEC/EN61643



**Intermediate Current Tester**

- UL 1449



**Accelerated Aging Tester**

- UL 1449 & IEC/EN61643



**Precision Salt Spraying Tester**

- ASTM B117 & IEC60068-2-11



**Fluke Network Analysis**

- UL497 & IEC/EN61643-21



**Oscilloscope**



**Digital Electric Bridge**



**SPD Component Tester**



**Varistor Parameter Tester**



# Certificates and International Patents



UL



KEMA



TUV



ISO 14001: 2015



ISO 45001: 2018



ISO 9001: 2015



US PATENT



GERMANY PATENT



KOREA PATENT



## Selecting SPD (UL 1449 5th Ed.)

- **Type 1** – Permanently connected SPDs intended for installation between the secondary of the service transformer and the line side of the service equipment overcurrent device, as well as the load side, including watt-hour meter socket enclosures and Molded Case SPDs intended to be installed without an external overcurrent protective device. Type 1 SPDs for use in PV systems can be connected between the PV array and the main service disconnect.

*SPDs investigated for Type 1 applications are automatically suitable for Type 2 applications and may be marked for SPD Type 1 and/or Type 2 applications. SPDs only marked "SPD Type 2" are not suitable for Type 1 applications.*

- **Type 2** – Permanently connected SPDs intended for installation on the load side of the service equipment overcurrent device; including SPDs located at the branch panel and Molded Case SPDs.
- **Type 3** – Point of utilization SPDs, installed at a minimum conductor length of 10 meters (30 feet) from the electrical service panel to the point of utilization, for example cord connected, direct plug-in, receptacle type and SPDs installed at the utilization equipment being protected. The distance (10 meters) is exclusive of conductors provided with or used to attach SPDs.
- **Type 4 Component Assemblies** – Component assembly consisting of one or more Type 5 components together with a disconnect (integral or external) or a means of complying with the limited current tests.
- **Type 1, 2, 3 Component Assemblies** – Consists of a Type 4 component assembly with internal or external short circuit protection.
- **Type 5** – Discrete component surge suppressors, such as MOVs that may be mounted on a PWB, connected by its leads or provided within an enclosure with mounting means and wiring terminations.

*Type 5 SPDs and Types 1, 2, 3 and 4 component assemblies are intended only for factory installation within another component, device or product.*

## Glossary

### SURGE PROTECTIVE DEVICE (SPD)

- A device composed of at least one non-linear component (MOV, GDT, etc.) and intended for limiting surge voltages on equipment by diverting or limiting surge current and is capable of repeating these functions as specified. SPDs were previously known as Transient Voltage Surge Suppressors (TVSS) or secondary surge arresters.

### SURGE

- A transient wave of current, potential or power in an electric circuit. Surges do not include temporary overvoltages (TOV) consisting of an increase in the power frequency voltage for several cycles.

### VOLTAGE PROTECTION RATING (VPR)

- A rating selected from a list of preferred values as given in the latest revision of ANSI/UL 1449. The value of VPR is determined as a higher value taken from table of UL 1449 to the average measured limiting voltage determined during the first set of measured limiting voltages tests during the transient-voltage surge suppression test using the combination wave generator at a setting of 6kV, 3kA. As a standardized rating system, VPR allows the direct comparison between like SPDs (i.e. same Type and Voltage).

### MAXIMUM CONTINUOUS OPERATING VOLTAGE (MCOV)

- The maximum designated root-mean-squared (rms) value of the power frequency voltage that may be continuously applied to the mode of protection of an SPD.

### SHORT CIRCUIT CURRENT RATING (SCCR) OF SPD

- The suitability of an SPD for use on an AC power circuit that is capable of delivering not more than a declared rms symmetrical current at a declared voltage during a short circuit condition. SCCR is not the same as AIC (Amp Interrupting Capacity). SCCR is the amount of "available" current that the SPD can be subjected to and safely disconnect from the power source under short circuit conditions. The amount of current "interrupted" by the SPD is typically significantly less than the "available" current.

### ENCLOSURE RATING

- Ensures that the NEMA rating of the enclosure matches the environmental conditions at the location where the device is to be installed.

Prosurge is among the very few companies who can provide the most extensive SPDs applicable for North American market. The product details are thoroughly presented in later parts of this catalog.

Before we go into details, we would like to give a brief introduction so that you can have a general idea in the shortest time.

Basically, our SPDs can be classified into 6 categories:

### SPD Components

PTMOV / 20PTMOV: I<sub>max</sub> 25/50kA  
 SMTMOV / HSMTMOV: I<sub>max</sub> 50/75kA  
 PCB Assembly: Enclosure-less surge panel



### Panel SPDs



### DIN-rail SPDs for AC & PV / DC



### SPDs for Information System



### Surge Monitoring & Measurement



### Intelligent SPD (iSPD)



Our SPDs for power supply system can also be classified into 2 categories by UL1449 standard:

- Type 1CA (Component Assembly) SPD with UL recognized mark including:



- DIN-rail SPD (both AC & DC)
- PTMOV / 20PTMOV (I<sub>max</sub> 25/50kA, smaller size)
- SMTMOV / HSMTMOV (I<sub>max</sub> 50/75kA, bigger size)
- PCB Assembly (an enclosure-less SPD or a semi-completed SPD)

- Type 1/2 SPD with UL listed mark including:



- PSP series SPD (25~600kA per phase surge capacity) with 5 different enclosures: E, B, F, C1, C2 using PTMOV / 20PTMOV as key component.
- PS series (150~900kA per phase surge capacity) with waterproof plastic/metal enclosure using SMTMOV / HSMTMOV as key component, and in compliance with IEC/EN61643-11 standards too.



# CONTENTS

## SPD Components

Thermally Protected MOV - PTMOV & SMTMOV .....	9-10
--	------

PCB Assembly .....	11-12
--------------------	-------

## Panel SPDs

PSP Series (General) .....	13-14
----------------------------	-------

PSP E   25~100kA (Multi-phase) .....	15-17
--------------------------------------	-------

PSP B   50kA (Multi-phase) .....	18-19
----------------------------------	-------

20PSP B   50~100kA (Multi-phase) .....	20-23
--	-------

PSP F   50kA (Multi-phase) .....	24-26
----------------------------------	-------

PSP C   100~600kA (Multi-phase) .....	27-30
---------------------------------------	-------

PS Series - max. 900kA (Multi-phase) .....	31-35
--	-------

## Plug-on SPDs

POSP Series - 50kA(Split-phase) .....	36
---------------------------------------	----

## DIN-rail SPDs

AC Power DIN-rail SPDs   UL .....	37-43
-----------------------------------	-------

DC Power / Photovoltaic System SPDs .....	44-47
---	-------

<b>Surge Protection for LED Lighting</b> .....	48-49
--	-------

<b>Surge Protection for Information System</b> .....	50-55
--	-------

<b>Surge Monitoring &amp; Measurement</b> .....	56-58
---	-------

<b>Surge Circuit Breaker (SCB)</b> .....	59
--	----

<b>Intelligent Surge Protective Device (iSPD)</b> .....	60-62
---	-------



## PTMOV & SMTMOV

PTMOV & SMTMOV are our feature products and fully reflect our expertise and creativity in SPD. They have a significant advantage in abnormal over-voltage & high fault current safety to ensure industry's highest level of safety and performance. They are widely adopted by global customers as most crucial inside surge protective components for electrical and electronic equipment and various SPD, especially Type 1 and Type 2 surge panels.

### Rating :

- **MCOV (Vac): 150V~690V**
- **Max. discharge current (8/20us): 25kA(PTMOV), 50kA(20PTMOV,SMTMOV), 75kA(HSMTMOV)**
- **Short circuit current rating (SCCR): 200kArms - tested without external CB or fuse**

### Features:

- UL recognized Type 1CA SPD per ANSI/UL1449 5th and CSA C22.2 -UL File No. E319871.
- Global patented thermal disconnecter design with arc extinguishing device, fail-safe & self-protected, quick thermal response and perfect circuit cutoff function.
- PCB mounting design, compatible with reflow and wave soldering procedure
- Visual fault indication and optional remote signal contact (rating: 0.1A, 12Vdc max)
- Wide operating temperature: -40°C~85°C
- Type 1CA design & Compact size, can be used individually or in combination for OEM customer
- Meet ANSI/UL1449 5th, IEC/EN 61643-11/31, EN50539-11 standards.

### Applications:

- Built-in surge protection of electronic equipment
- Surge protected devices applications
- AC/DC distribution
- Computer and data technology
- Power supply
- Telecommunication
- Measurement and control system

UL 1449 5th Edition, effective in January 2021, has replaced 4th Edition, furthering the surge protection standards to prevent fire risk while using MOVs.

Prosurge's patented TMOV (PTMOV & SMTMOV) has passed all UL 1449 5th Edition tests.

SPDs not properly designed or incorrectly used and unprotected MOVs may go into thermal runaway, resulting in short circuit, overheating, smoke, and potentially fire hazard due to:

- End of life
- Sustained abnormal over-voltage (TOV)
- Surge with unexpected energy

PTMOV & SMTMOV perform an effective fail-safe and self-protected function when thermal runaway happend due to their super quick themal response.

Unlike the unprotected MOV, PTMOV & SMTMOV can cut off the short circuit current and extinguish the arc, permanently and securely disconnect themselves from the power system to prevent fire hazard.



MOV burned by TOV



Type	PTMOV	20PTMOV	SMTMOV	HSMTMOV
In accordance with	ANSI/UL1449 5th; IEC/EN61643-11; CSA C22.2			
Category UL	Type 1CA			
Max. Continuous Operating Voltage (MCOV)	150~690Vac	150~550Vac	150~690Vac	150~320Vac
Nominal Discharge Current (8/20µs) I <sub>n</sub> x 15 times	10kA	20kA	20kA	20kA
Max. Discharge Current (8/20µs) I <sub>max</sub> x 1 time	25kA	50kA	50kA	75kA
SCCR Rating	200kA			
Response Time	≤25 ns			
Operating Temperature Range	- 40°C ~ + 80°C		- 40°C ~ + 85°C	
Enclosure Material	thermoplastic; extinguishing degree UL94 V-0			
Insulation Resistance	≥10 MOhm			
Electric Strength	≥2500V			
Disconnecter Instructions	none		viewed through top hole of plastic housing	
Remote Alarm Contact	switching isolation			





Part No.	MCOV		Surge Current		VPR
	Vac (V)	Vdc (V)	I <sub>max</sub> (x 1 time @8/20µs)	I <sub>n</sub> (x15 times @8/20µs)	
PTMOV150/S	150	200	25kA	10kA	600V
PTMOV180/S	180	230	25kA	10kA	800V
PTMOV320/S	320	410	25kA	10kA	1000V
PTMOV420/S	420	560	25kA	10kA	1200V
PTMOV550/S	550	745	22kA	10kA	1800V
PTMOV690/S	690	910	22kA	10kA	2000V
20PTMOV150/S	150	200	50kA	20kA	600V
20PTMOV320/S	320	410	50kA	20kA	1000V
20PTMOV420/S	420	560	50kA	20kA	1200V
20PTMOV550/S	550	745	50kA	20kA	1800V

- Dimension drawing

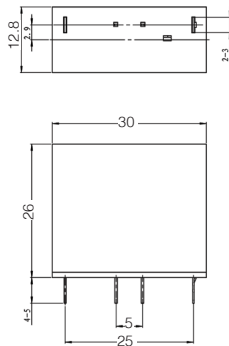

PTMOVxxx/S (MCOV 150-420Vac)

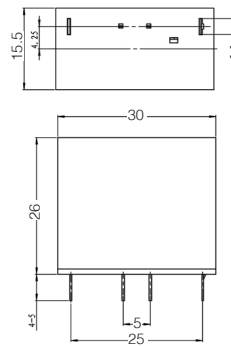

PTMOVxxx/S (MCOV 550-690Vac)  
& 20PTMOVxxx/S

- Basic circuit diagram

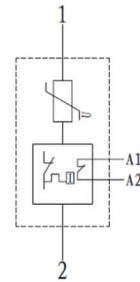

Part No.	MCOV		Surge Current		VPR
	Vac (V)	Vdc (V)	I <sub>max</sub> (x 1 time @8/20µs)	I <sub>n</sub> (x15 times @8/20µs)	
SMTMOV150	150	200	50kA	20kA	600V
SMTMOV180	180	230	50kA	20kA	600V
SMTMOV275A	275	350	50kA	20kA	800V
SMTMOV320	320	410	50kA	20kA	1000V
SMTMOV420	420	560	50kA	20kA	1500V
SMTMOV550	550	745	50kA	20kA	1500V
SMTMOV690	690	910	40kA	20kA	2000V
HSMTMOV150	150	200	75kA	20kA	600V
HSMTMOV275A	275	350	75kA	20kA	800V
HSMTMOV320	320	410	75kA	20kA	1000V

- Dimension drawing

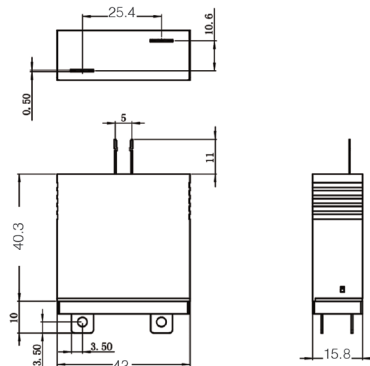

- Basic circuit diagram

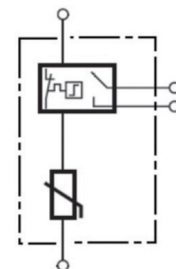



## PCB Assembly for Local Made / SKD

Prosurge PCBA series are one-stop high performance surge protection solution for worldwide OEM customer. They are full-functional and flexible surge protection PCB assembly and thus will significantly simplify customer's investment on designing and certifying to manufacturing, and ensure an efficient local-made product at minimum cost.

PCBA series fully meet the demanding protection requirements of equipment operating in high-risk or critical commercial and industrial environments. By employing Prosurge's patented technology, a thermally protected and arc extinguishing MOV technology, PCBAs have a significant advantage in abnormal over-voltage & high fault current safety to deliver industry's highest level of safety and performance. The parallel redundancy modules design makes the PCBAs more robust and reliable and ensures that they can handle great impulse current up to 300kA (8/20µs) and multiple impulse current at its highest rated level.

### Features:

- UL 1449 5th Type 1CA recognized with SCCR up to 200kArms without external fuse or CB
- UL1449 5th Type 2CA with sine wave tracking, SCCR up to 200kArms
- Patented PTMOV/20PTMOV (PSP PCBA), SMTMOV/HSMTMOV (PS PCBA) as key component
- Full modes protection
- Large surge energy capability up to 300kA (8/20µs) with compact size
- Low voltage protection level
- Failure indication
- Surge event counter optional
- Failure pre-test
- Remote Alarm

### Applications:

- ANSI/UL1449 Type 1/Type 2 location Surge Protective Devices OEM building
- ANSI/IEEE C62.41 Category B, C, D, E Surge Protective Devices OEM building
- IEC 61643-1/11 Class I/II Surge Protective Devices OEM building



### Key Component:



PSP PCBA: PTMOV/20PTMOV



PS PCBA: SMTMOV/HSMTMOV

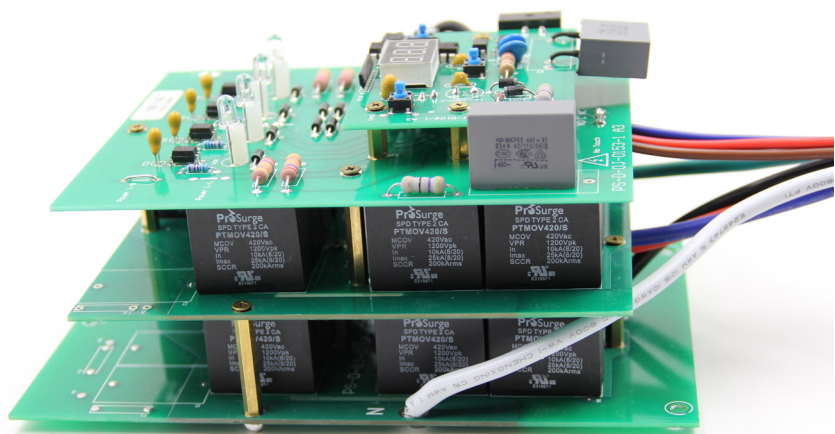



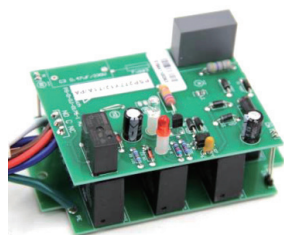

**Type B, PSP PCBA**

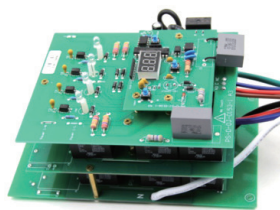

**Type C, PSP PCBA**

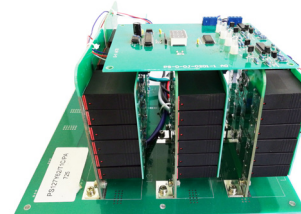

**Type D, PS PCBA**

PSP PCBA Type	PSP B	PSP C1	PSP C2	PS D
Certifications	ANSI/UL 1449 & CSA C22.2 Type 1/2CA			
Connection Type	Parallel Connected			
Enclosure Recommend & Dimensions, W x D x H	Plastic enclosure 130 mm x 80 mm x 70mm (min.)	Plastic enclosure 200 x 150 x 100 mm (min.)	Metal enclosure 260 x 190 x 109 mm (min.)	Metal enclosure 350 x 340 x 225 mm (min.)
Surge Capacity	50-100kA/phase	100-600kA/phase		150~900kA/phase
SCCR Rating	200kArms			
Sine Wave Tracking	Optional for UL Type 2 certification			
Lightning Counter	No	≥ 200A (with Reset button)		
Failure Pre-Test	No	Press 2S (test button)		
Power Status Indication	Normal = Power LED ON	Normal=Blue LED ON		
Working Status Indication	Fail=Surge protection LED ON	Normal= Blue LED ON; Fail= Blue LED turn to Red		AFM (three-stage indication)
Power Connecting	12AWG	10AWG		8AWG
Signal Cable	16AWG (C Red; NC Blue; NO Brown)			
Working Environments	Temperature -40°C~+75°C			Temperature -40°C~+80°C
	Humidity relative 5~95% (25°C), Altitude ≤ 2km			
PCBA Dimensions	110 x70 x 57mm	173 x 122 x 85 mm	189 x 122 x 85 mm	284 x 254 x 155 mm
Mounting Hole	Two holes, and distance: 110mm	Three holes: 70x155 mm	Three holes: 105.7x178 mm	Four holes: 140x112 mm
Net Weight (Typical Value)	0.23 kg	1.0 kg	1.0 kg	6.5 kg

**Note:**

To meet the requirement of air clearance and creepage distance, there is slight dimension difference between Type C1 and Type C2 due to enclosure material.

The detailed technical data of PSP PCBA can be referred to PSP B & PSP C technical data as listed in later parts of this catalog, and detailed technical data of PS PCBA can be referred to PS series in later parts.



### PSP Series Panel SPDs

Prosurge PSP series panel SPDs are defined as one-stop high performance surge protection solution for most commercial and industrial environments with critical operations, include Type 1 and Type 2 Surge Protective Devices that protect against the risk of the harmful effects of transient surges. These surges are the result of:

- Direct and indirect lightning strikes
- Power company load switching
- Upstream load switching at other facilities

#### Rating :

- **MCOV (Vac): 150V~690V**
- **Surge capacity (8/20µs): 25~600kA per phase**
- **Short circuit current rating (SCCR): 200kArms - tested without external CB or fuse**

#### Features:

- UL Listed Type 1 (ANSI/UL1449 5th, CSA C22.2) SPDs
- UL Listed Type 2 (ANSI/UL1449 5th, CSA C22.2) SPDs with sine wave tracking
- Prosurge patented SCCR 200kArms thermally protected MOV technology (PTMOV/20PTMOV) as key component
- Full modes protection & High surge energy capability in compact size
- Sine wave tracking function optional (for UL Type 2 listed model, UL1283 listed EMI/RFI filter for C series)
- Low voltage protection rating
- Waterproof plastic/metal enclosure to resist dirt, dust and water
- Failure indication
- Surge event counter optional
- Floating changeover contact for remote alarm
- Threaded NPT

#### Typical Application:

- Commercial
- Industrial
- Communications
- Renewable energy
- Critical power (hospitals, data centers, etc.)



Adopt PTMOV/20PTMOV as Key Component



**Configuration & Ordering Information:**

PSP Model	277Y Voltage and system configuration	C Protection mode	42 Surge capacity	M Enclosure	/T1 SPD Category	CTA Additional function
<p><i>Model:</i></p> <p><u>PSP</u></p> <p><u>20PSP</u></p> <p><u>HPSP</u></p>	<p><u>120SP</u>: 120/240V split</p> <p><u>240SP</u>: 240/480V split</p> <p><u>120Y</u>: 120/208V WYE</p> <p><u>277Y</u>: 277/480V WYE</p> <p><u>120H</u>: 120/240V high-leg delta</p> <p><u>240D</u>: 240V delta</p> <p><u>120S</u>: 120V 1ph, 2W+G</p> <p>...</p>	<p><u>C</u>: Delete N-G protection mode</p>	<p><u>11</u>: 25kA(or 50*)/phase</p> <p><u>12</u>: 50kA(or 100*)/phase</p> <p><u>22</u>: 100kA(or 200*)/phase</p> <p><u>32</u>: 150kA(or 300*)/phase</p> <p><u>42</u>: 200kA(or 400*)/phase</p> <p><u>52</u>: 250kA(or 500*)/phase</p> <p><u>62</u>: 300kA(or 600*)/phase</p>	<p><u>M</u>: metal enclosure (Only C2 type)</p> <p>*Part No. without M means plastic enclosure (E, B, C1 type)</p>	<p><u>T1</u>: UL type 1 SPD</p> <p><u>T2F</u>: UL type 2 SPD with sine wave tracking</p>	<p><u>C</u>: surge event counter</p> <p><u>T</u>: failure pretest</p> <p><u>A</u>: remote alarm</p>

Note: \* While 20PTMOV is used, only for specify model.

**Voltage code for power distribution system**

- 120SP , 240SP = 120/240V; 240/480V ..... **Split-phase three-wire +ground (Figure 1)**
- 120Y, 127Y, 240Y, 277Y, 347Y = 208Y120V, 220Y127V, 380Y220V & 400Y230V & 415Y240V, 480Y277V, 600Y347V ..... **Three-phase wye (star) four-wire +ground (Figure 2)**
- 120H, 240H = 120/240V, 240V/480V ..... **Three-phase high-leg delta (Figure 3)**
- 240D, 480D, 600D = 240V, 480V, 600V..... **Three-phase delta three-wire +ground (Figure 4)**
- 120S, 127S, 240S, 277S, 347S =120V,127V, 220V&230V&240V, 277V, 347V ..... **Single-phase two-wire +ground (Figure 5)**

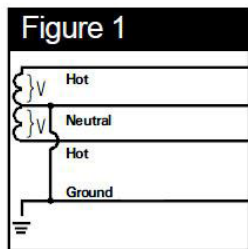

**SPLIT**  
2 Hots, 1 Neu, 1 Grnd

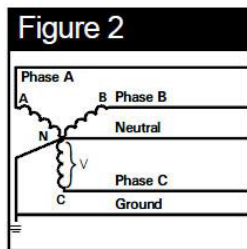

**WYE**  
3 Hots, 1 Neu, 1 Grnd

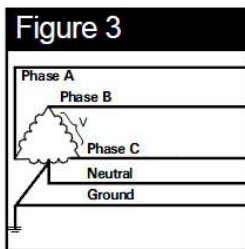

**HI-LEG DELTA (B High)**  
3 Hots, (B HIGH),  
1 Neu, 1 Grnd

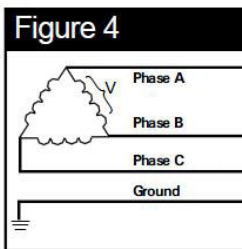

**DELTA & HRG WYE**  
3 Hots, 1 Grnd

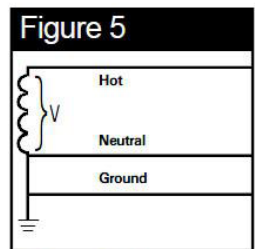

**SINGLE POLE**  
1 Hot, 1 Neu, 1 Grnd





PSP E series panel SPDs are extra compact UL Type 1 SPD designed to protect single phase and multi-phase electrical distribution systems against the harmful effects of transient surges. They are constructed with Prosurge's PTMOV which has a significant advantage in abnormal over-voltage & high fault current safety and thus ensure industry's highest level of safety and performance. They are tested and listed as Type 1 SPD, ANSI/UL1449 5th, CSA C22.2.



PSP Category	PSPE
Certification	ANSI/UL1449 5th, CSA C22.2, Type1
Connection Type	Parallel Connected
Surge Capacity	25~50kA per phase
Nominal Discharge Current (In)	10kA
SCCR	200kArms
Power Status Indication	Normal= LED ON
Working Status Indication	Fail= LED OFF
Power Connecting	12AWG (L=black; N=white; PE=green)
Working Environments	Temperature -40°C~+80°C; Humidity relative 5~95% (25°C); Altitude≤3km
Dimensions, W x D x H	90x58x41 mm
Enclosure	Waterproof enclosure
Threaded NPT	1/2" NPT
Net Weight(Typical Value)	0.18kg

**Typical Application:**

- Outdoor/Indoor and commercial LED lighting
- Medical electronics
- Manufacturing facilities
- Telecommunication equipment
- Security & alarm equipment
- Other critical electronic equipment

**PSPE (In:10kA) - Technical Data:**

Model No.	System Voltage (50/60Hz)	In (kA)	Protected Mode				Voltage Protection Ratings (VPR @6KV/ 3kA,V)				Surge Capacity per phase	MCOV (Vac)
			L-N	L-G	N-G	L-L	L-N	L-G	N-G	L-L		
PSPE120SP11/T1	120/240V Split-phase	10	x	✓	x	✓	-	700	-	1500	25kA	150/300
PSPE120SP12/T1			x	✓	x	✓	-	700	-	1200	50kA	150/320
PSPE120SPN11/T1	120/240V Split-phase	10	✓	x	x	✓	700	-	-	1500	25kA	150/300
PSPE120SPN12/T1			✓	x	x	✓	700	-	-	1200	50kA	150/320
PSPE120SPNG11/T1			✓	✓	✓	✓	800	1500	800	1500	25kA	150/300
PSPE240SP11/T1	240/480V Split-phase	10	x	✓	x	✓	-	1200	-	2500	25kA	320/640
PSPE240SP12/T1			x	✓	x	✓	-	1200	-	1800	50kA	320/550
PSPE240SPN11/T1	240/480V Split-phase	10	✓	x	x	✓	1200	-	-	2500	25kA	320/640
PSPE240SPN12/T1			✓	x	x	✓	1200	-	-	1800	50kA	320/550
PSPE240SPNG11/T1			✓	✓	✓	✓	1200	2500	1200	2500	25kA	320/640
PSPE127S11/T1	127V Single-phase	10	✓	✓	✓	x	1500	700	700	-	25kA	150
PSPE127S12/T1			✓	✓	✓	x	700	700	700	-	50kA	150
PSPE277S11/T1	277V Single-phase	10	✓	✓	✓	x	2500	1200	1200	-	25kA	320
PSPE277S12/T1			✓	✓	✓	x	1200	1200	1200	-	50kA	320
PSPE347S11/T1	347V Single-phase	10	✓	✓	✓	x	3000	1500	1500	-	25kA	420
PSPE347S12/T1			✓	✓	✓	x	1500	1500	1500	-	50kA	420



Model No.	System Voltage (50/60Hz)	In (kA)	Protected Mode				Voltage Protection Ratings (VPR @6kV/ 3kA.V )				Surge Capacity per phase	MCOV (Vac)
			L-N	L-G	N-G	L-L	L-N	L-G	N-G	L-L		
PSPE240D11/T1	240V Three-phase delta	10	x	✓	x	✓	-	1200	-	2500	25kA	320
PSPE480D11/T1	480V Three-phase delta	10	x	✓	x	✓	-	1800	-	4000	25kA	550
PSPE600D11/T1	600V Three-phase delta	10	x	✓	x	✓	-	2000	-	4000	25kA	690
PSPE120YC11/T1	208Y120V Three-phase wye No neutral	10	x	✓	x	✓	-	800	-	1500	25kA	150
PSPE127YC11/T1	220Y127V Three-phase wye No neutral	10	x	✓	x	✓	-	800	-	1500	25kA	150
PSPE240YC11/T1	415Y240V Three-phase wye No neutral	10	x	✓	x	✓	-	1200	-	2500	25kA	320
PSPE277YC11/T1	480Y277V Three-phase wye No neutral	10	x	✓	x	✓	-	1200	-	2500	25kA	320
PSPE347YC11/T1	600Y347V Three-phase wye No neutral	10	x	✓	x	✓	-	1500	-	3000	25kA	420
PSPE120YN11/T1	208Y120V Three-phase wye 4W	10	✓	x	x	✓	800	-	-	1500	25kA	150
PSPE127YN11/T1	220Y127V Three-phase wye 4W	10	✓	x	x	✓	800	-	-	1500	25kA	150
PSPE240YN11/T1	415Y240V Three-phase wye 4W	10	✓	x	x	✓	1200	-	-	2500	25kA	320
PSPE277YN11/T1	480Y277V Three-phase wye 4W	10	✓	x	x	✓	1200	-	-	2500	25kA	320
PSPE347YN11/T1	600Y347V Three-phase wye 4W	10	✓	x	x	✓	1500	-	-	3000	25kA	420



**PSP E - Basic Circuit Diagram**

PSPE...	PSPE...SP11...	PSPE...SP12...	PSPE...S11...	PSPE...S12...
Un/ Power System (50/60Hz)	120/240VAC split phase 240/480VAC split phase	120/240VAC split phase 240/480VAC split phase ...	120VAC single phase 127VAC single phase 240VAC single phase 277VAC single phase 347VAC single phase ...	120VAC single phase 127VAC single phase 240VAC single phase 277VAC single phase 347VAC single phase ...

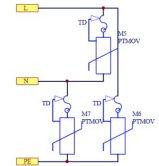
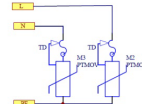
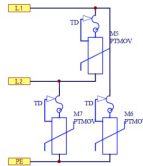
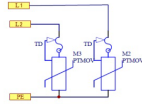

PSPE...	PSPE...SPN11...	PSPE...SPN12...	PSPE...SPNG11...	PSPE...D11...
Un/ Power System (50/60Hz)	120/240VAC split phase 240/480VAC split phase	120/240VAC split phase 240/480VAC split phase ...	120/240VAC split phase 240/480VAC split phase	240VAC three phase Delta 480VAC three phase Delta 600VAC three phase Delta

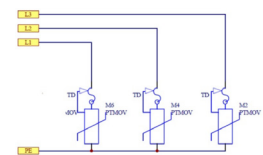
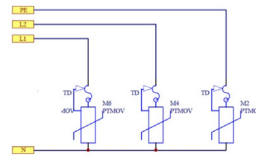
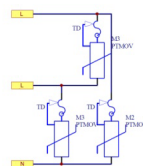
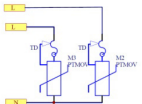

PSPE...	PSPE...YC11...	PSPE...YN11...
Un/ Power System (50/60Hz)	120/208VAC three phase WYE 240/415VAC three phase WYE 347/600VAC three phase WYE	120/208VAC three phase WYE 240/415VAC three phase WYE 347/600VAC three phase WYE

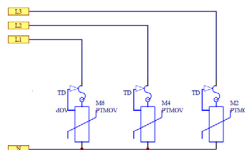
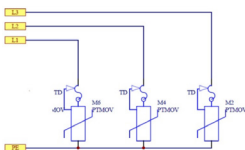

• Dimension drawing

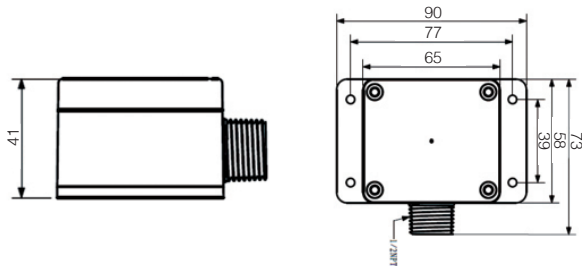





Prosurge PSP B series panel SPDs are compact Surge Protective Devices (SPDs), designed to protect single and multi-phase electrical distribution systems against the risk of the harmful effects of transient surges.



PSP Category	PSP B
Certification	ANSI / UL 1449 5th, CSA C22.2, Type 1, Type 2
Connection Type	Parallel Connected
Surge Capacity	50kA per phase
Nominal Discharge Current (In)	10kA
SCCR	200kArms
Sine Wave Tracking	For UL Type 2 listed
Power Status Indication	Normal=Power LED ON
Working Status Indication	Fail=Surge protection LED ON
Power Connecting	12 AWG (L1=black; L2=red; L3=blue; N=white; PE=green)
Signal Cable (Remote Alarm)	16 AWG (C=red; NC=blue; NO=brown)
Working Environment	Temperature: -40°C~+75°C; Humidity relative 5~95% (25°C); Altitude: ≤3km
Dimensions, W x D x H	162 x 80 x 76 mm
Threaded NPT	1/2"NPT
Enclosure	Waterproof plastic enclosure
Net Weight (Typical Value)	0.47 kg

- Dimension drawing

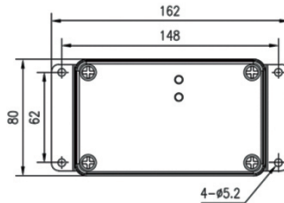
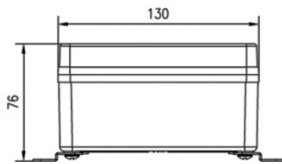

**Typical Application:**

In low & medium exposure locations

- Commercial
- Industrial
- Communications
- Renewable energy
- Critical power (hospitals, data centers, etc.)

**PSP B (In:10kA) - Technical Data:**

Model No.	System Voltage (50/60Hz)	In (kA)	Protected Mode				Voltage Protection Ratings (VPR @6kV/ 3kA, V)				Surge Capacity per phase	MCOV (Vac)
			L-N	L-G	N-G	L-L	L-N	L-G	N-G	L-L		
PSP120SP12/*A	120/240V Split-phase	10	✓	✓	✓	✓	700	700	700	1200	50kA	150/300
PSP120SPC12/*A	120/240V Split-phase No neutral	10	✗	✓	✗	✓	-	700	-	1200	50kA	150/300
PSP240SP12/*A	240/480V Split-phase	10	✓	✓	✓	✓	1200	1200	1200	2000	50kA	320/640
PSP240SPC12/*A	240/480V Split-phase No neutral	10	✗	✓	✗	✓	-	1200	-	2000	50kA	320/640
PSP120Y12/*A	208Y120V Three-phase wye	10	✓	✓	✓	✓	700	700	700	1200	50kA	150
PSP120YC12/*A	208Y120V Three-phase wye No neutral	10	✗	✓	✗	✓	-	700	-	1200	50kA	150
PSP127Y12/*A	220Y127V Three-phase wye	10	✓	✓	✓	✓	700	700	700	1200	50kA	150
PSP127YC12/*A	220Y127V Three-phase wye No neutral	10	✗	✓	✗	✓	-	700	-	1200	50kA	150
PSP240Y12/*A	415Y240V Three-phase wye	10	✓	✓	✓	✓	1200	1200	1200	2000	50kA	320
PSP240YC12/*A	415Y240V Three-phase wye No neutral	10	✗	✓	✗	✓	-	1200	-	2000	50kA	320
PSP277Y12/*A	480Y277V Three-phase wye	10	✓	✓	✓	✓	1200	1200	1200	2000	50kA	320
PSP277YC12/*A	480Y277V Three-phase wye No neutral	10	✗	✓	✗	✓	-	1200	-	2000	50kA	320
PSP347Y12/*A	600Y347V Three-phase wye	10	✓	✓	✓	✓	1500	1500	1500	2500	50kA	420
PSP347YC12/*A	600Y347V Three-phase wye No neutral	10	✗	✓	✗	✓	-	1500	-	2500	50kA	420
PSP120H12/*A	120/240V High-leg delta	10	✓	✓	✓	✓	700-1200HL	700-1200HL	700	1200-2000HL	50kA	150/320(HL)
PSP120HC12/*A	120/240V High-leg delta No neutral	10	✗	✓	✗	✓	-	700-1200HL	-	1200-2000HL	50kA	150/320(HL)
PSP240H12/*A	240/480V High-leg delta	10	✓	✓	✓	✓	1200-1800HL	1200-1800HL	1200	2000-3000HL	50kA	320/550(HL)



**PSP B - Technical Data:**

Model No.	System Voltage (50/60Hz)	In (kA)	Protected Mode				Voltage Protection Ratings (VPR @6kV/ 3kA,V)			Surge Capacity per phase	MCOV (Vac)	
			L-N	L-G	N-G	L-L	L-N	N-G	L-L			
PSP240HC12/*A	240/480V High-leg delta No neutral	10	✗	✓	✗	✓	-	1200-1800HL	-	-	50kA	320/550(HL)
PSP240D12/*A	240V Three-phase delta	10	✗	✓	✗	✓	-	1200	-	1200	50kA	320
PSP480D12/*A	480V Three-phase delta	10	✗	✓	✗	✓	-	1800	-	3000	50kA	550
PSP600D12/*A	600V Three-phase delta	10	✗	✓	✗	✓	-	2000	-	4000	50kA	690
PSP120S12/*A	120V Single-phase	10	✓	✓	✓	✗	700	700	700	-	50kA	150
PSP127S12/*A	127V Single-phase	10	✓	✓	✓	✗	700	700	700	-	50kA	150
PSP240S12/*A	240V Single-phase	10	✓	✓	✓	✗	1200	1200	1200	-	50kA	320
PSP277S12/*A	277V Single-phase	10	✓	✓	✓	✗	1200	1200	1200	-	50kA	320
PSP347S12/*A	347V Single-phase	10	✓	✓	✓	✗	1500	1500	1500	-	50kA	420

**PSP B - Basic Circuit Diagram**

Un/ Power System (50/60 Hz)	Basic Surge Protection Circuit Diagram	
	Power System with Neutral Line	Power System without Neutral Line
120/240VAC split phase 240/480VAC split phase ...	PSP...SP12...(3W+G) 	PSP...SPC12...(2W+G) 
120VAC single phase 127VAC single phase 220VAC single phase 230VAC single phase 240VAC single phase 277VAC single phase 347VAC single phase ...	PSP...S12...(2W+G) 	
120/208VAC WYE 127/220VAC WYE 220/380VAC WYE 230/400VAC WYE 240/415VAC WYE 277/480VAC WYE 347/600VAC WYE ...	PSP...Y12...(4W+G) 	PSP...YC12...(3W+G) 
240VAC Delta 480VAC Delta 600VAC Delta ...		PSP...D12...(3W+G) 
120/240VAC High-leg delta 240/480VAC High-leg delta ...	PSP...H12...(4W+G, L2 is High-leg) 	PSP...HC12...(3W+G, L2 is High-leg) 



Prosurge 20PSP B series panel SPDs are compact Surge Protective Devices (SPDs) with nominal discharge current as 20kA, designed to protect single and multi-phase electrical distribution systems against the risk of the harmful effects of transient surges.



PSP Category	20PSP B
Certification	ANSI / UL 1449 5th, CSA C22.2, Type 1, Type 2
Connection Type	Parallel Connected
Surge Capacity	50/100kA per phase
Nominal Discharge Current (In)	20kA
SCCR	200kArms
Sine Wave Tracking	For UL Type 2 listed
Power Status Indication	Normal=Power LED ON
Working Status Indication	Fail=Surge protection LED ON
Power Connecting	12 AWG (L1=black; L2=red; L3=blue; N=white; PE=green)
Signal Cable (Remote Alarm)	16 AWG (C=red; NC=blue; NO=brown)
Working Environment	Temperature: -40°C~+75°C; Humidity relative 5~95% (25°C); Altitude: ≤3km
Dimensions, W x D x H	162 x 80 x 76 mm
Threaded NPT	1/2"NPT
Enclosure	Waterproof plastic enclosure
Net Weight (Typical Value)	0.5 kg

• Dimension drawing

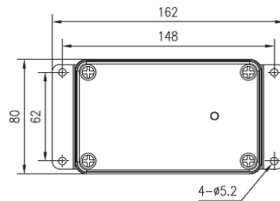
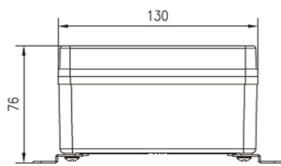

**Typical Application:**

In low & medium exposure locations

- Commercial
- Industrial
- Communications
- Renewable energy
- Critical power (hospitals, data centers, etc.)

**20PSP B (Surge capacity 100kA) - Technical Data:**

Model No.	System Voltage (50/60Hz)	In (kA)	Protected Mode				Voltage Protection Ratings (VPR @6kV/ 3kA, V)				Surge Capacity per phase	MCOV (Vac)
			L-N	L-G	N-G	L-L	L-N	L-G	N-G	L-L		
20PSP120SP12/*A	120/240V Split-phase	20	✓	✓	✓	✓	700	700	700	1200	100kA	150/300
20PSP120SPC12/*A	120/240V Split-phase No neutral	20	✗	✓	✗	✓	-	700	-	1200	100kA	150/300
20PSP240SP12/*A	240/480V Split-phase	20	✓	✓	✓	✓	1200	1200	1200	2000	100kA	320/640
20PSP240SPC12/*A	240/480V Split-phase No neutral	20	✗	✓	✗	✓	-	1200	-	2000	100kA	320/640
20PSP120Y12/*A	208Y120V Three-phase wye	20	✓	✓	✓	✓	700	700	700	1200	100kA	150
20PSP120YC12/*A	208Y120V Three-phase wye No neutral	20	✗	✓	✗	✓	-	700	-	1200	100kA	150
20PSP127Y12/*A	220Y127V Three-phase wye	20	✓	✓	✓	✓	700	700	700	1200	100kA	150
20PSP127YC12/*A	220Y127V Three-phase wye No neutral	20	✗	✓	✗	✓	-	700	-	1200	100kA	150
20PSP240Y12/*A	415Y240V Three-phase wye	20	✓	✓	✓	✓	1200	1200	1200	2000	100kA	320
20PSP240YC12/*A	415Y240V Three-phase wye No neutral	20	✗	✓	✗	✓	-	1200	-	2000	100kA	320
20PSP277Y12/*A	480Y277V Three-phase wye	20	✓	✓	✓	✓	1200	1200	1200	2000	100kA	320
20PSP277YC12/*A	480Y277V Three-phase wye No neutral	20	✗	✓	✗	✓	-	1200	-	2000	100kA	320



**20PSP B (Surge capacity 100kA) - Technical Data:**

Model No.	System Voltage (50/60Hz)	In (kA)	Protected Mode				Voltage Protection Ratings (VPR @6kV/ 3kA,V)				Surge Capacity per phase	MCOV (Vac)
			L-N	L-G	N-G	L-L	L-N	L-G	N-G	L-L		
20PSP120H12/*A	120/240V High-leg delta	20	✓	✓	✓	✓	700-1200HL	700-1200HL	700	1200-2000HL	100kA	150/320(HL)
20PSP120HC12/*A	120/240V High-leg delta No neutral	20	✗	✓	✗	✓	-	700-1200HL	-	1200-2000HL	100kA	150/320(HL)
20PSP240D12/*A	240V Three-phase delta	20	✗	✓	✗	✓	-	1200	-	1200	100kA	320
20PSP120S12/*A	120V Single-phase	20	✓	✓	✓	✗	700	700	700	-	100kA	150
20PSP127S12/*A	127V Single-phase	20	✓	✓	✓	✗	700	700	700	-	100kA	150
20PSP240S12/*A	240V Single-phase	20	✓	✓	✓	✗	1200	1200	1200	-	100kA	320
20PSP277S12/*A	277V Single-phase	20	✓	✓	✓	✗	1200	1200	1200	-	100kA	320

**20PSP B (Surge capacity 100kA) - Basic Circuit Diagram**

Un/ Power System (50/60 HZ)	Basic Surge Protection Circuit Diagram	
	Power System with Neutral Line	Power System without Neutral Line
120/240VAC split phase 240/480VAC split phase ...	20PSP...SP12...(3W+G) 	20PSP...SPC12...(2W+G) 
120VAC single phase 127VAC single phase 220VAC single phase 230VAC single phase 240VAC single phase 277VAC single phase 347VAC single phase ...	20PSP...S12...(2W+G) 	
120/208VAC WYE 127/220VAC WYE 220/380VAC WYE 230/400VAC WYE 240/415VAC WYE 277/480VAC WYE 347/600VAC WYE ...	20PSP...Y12...(4W+G) 	20PSP...YC12...(3W+G) 
240VAC Delta 480VAC Delta 600VAC Delta ...		20PSP...D12...(3W+G) 
120/240VAC High-leg delta 240/480VAC High-leg delta ...	20PSP...H12...(4W+G, L2 is High-leg) 	20PSP...HC12...(3W+G, L2 is High-leg) 





**20PSP B (Surge capacity 50kA) - Technical Data:**

Model No.	System Voltage (50/60Hz)	In (kA)	Protected Mode				Voltage Protection Ratings (VPR @6kV/ 3kA,V)				Surge Capacity per phase	MCOV (Vac)
			L-N	L-G	N-G	L-L	L-N	L-G	N-G	L-L		
20PSP120SPNN11/*A	120/240V Split-phase	20	✓	✗	✗	✓	700	-	-	1200	50kA	150/300
20PSP120SPG11/*A		20	✗	✓	✓	✓	-	700	700	1200	50kA	150/300
20PSP120SPN11/*A		20	✓	✗	✓	✓	700	-	700	1200	50kA	150/300
20PSP240SPNN11/*A	240/480V Split-phase	20	✓	✗	✗	✓	1200	-	-	2000	50kA	320/640
20PSP240SPG11/*A		20	✗	✓	✓	✓	-	1200	1200	2000	50kA	320/640
20PSP240SPN11/*A		20	✓	✗	✓	✓	1200	-	1200	2000	50kA	320/640
20PSP127YG11/*A	220Y127V Three-phase wye	20	✗	✓	✓	✓	-	700	700	1200	50kA	150
20PSP127YN11/*A		20	✓	✗	✓	✓	700	-	700	1200	50kA	150
20PSP127YCG11/*A		20	✗	✓	✗	✓	-	700	-	1200	50kA	150
20PSP127YNN11/*A		20	✓	✗	✗	✓	700	-	-	1200	50kA	150
20PSP277YG11/*A	480Y/277V Three-phase wye	20	✗	✓	✓	✓	-	1200	1200	2000	50kA	320
20PSP277YN11/*A		20	✓	✗	✓	✓	1200	-	1200	2000	50kA	320
20PSP277YCG11/*A		20	✗	✓	✗	✓	-	1200	-	2000	50kA	320
20PSP277YNN11/*A		20	✓	✗	✗	✓	1200	-	-	2000	50kA	320
20PSP347YG11/*A	600Y347V Three-phase wye	20	✗	✓	✓	✓	-	1500	1500	2500	50kA	420
20PSP347YN11/*A		20	✓	✗	✓	✓	1500	-	1500	2500	50kA	420
20PSP347YCG11/*A		20	✗	✓	✗	✓	-	1500	-	2500	50kA	420
20PSP347YNN11/*A		20	✓	✗	✗	✓	1500	-	-	2500	50kA	420
20PSP120HG11/*A	120/240V High leg delta	20	✗	✓	✓	✓	-	700-1200HL	700	1200-2000HL	50kA	150/320(HL)
20PSP120HN11/*A		20	✓	✗	✓	✓	700-1200HL	-	700	1200-2000HL	50kA	150/320(HL)
20PSP240HG11/*A	240/480V High leg delta	20	✗	✓	✓	✓	-	1200-1800HL	1200	2000-3000HL	50kA	320/550(HL)
20PSP240HN11/*A		20	✓	✗	✓	✓	1200-1800HL	1200-1800HL	1200	2000-3000HL	50kA	320/550(HL)
20PSP240DG11/*A	240V Three-phase delta	20	✗	✓	✗	✓	-	1200	-	1200	50kA	320
20PSP480DG11/*A	480V Three-phase delta	20	✗	✓	✗	✓	-	1800	-	3000	50kA	550
20PSP127SG11/*A	127V Single-phase	20	✗	✓	✓	✗	-	700	700	-	50kA	150
20PSP127SN11/*A		20	✓	✗	✓	✗	700	-	700	-	50kA	150
20PSP277SG11/*A	277V Single-phase	20	✗	✓	✓	✗	-	1200	1200	-	50kA	320
20PSP277SN11/*A		20	✓	✗	✓	✗	1200	-	1200	-	50kA	320
20PSP347SG11/*A	347V Single-phase	20	✗	✓	✓	✗	-	1500	1500	-	50kA	420
20PSP347SN11/*A		20	✓	✗	✓	✗	1500	-	1500	-	50kA	420



**20PSP B (Surge capacity 50kA) - Basic Circuit Diagram**

Un/ Power system (50/60 HZ)	Basic Surge Protection Circuit Diagram			
120/240 VAC split phase 240/480 VAC split phase ...	<p>20PSP ...SPN11...(3W+G)</p>	<p>20PSP ...SPG11...(3W+G)</p>	<p>20PSP ...SPNN11...(3W)</p>	<p>20PSP ...SPOG11...(2W+G)</p>
127 VAC single phase 230 VAC single phase 277 VAC single phase 347 VAC single phase ...	<p>20PSP ...SN11...(2W+G)</p>	<p>20PSP ...SG11...(2W+G)</p>		
127/220 VAC WYE 230/400 VAC WYE 277/480 VAC WYE 347/600 VAC WYE ...	<p>20PSP ...YN11...(4W+G)</p>	<p>20PSP ...YG11...(4W+G)</p>	<p>20PSP ...YNN11...(4W)</p>	<p>20PSP ...YCG11...(3W+G)</p>
240 VAC Delta 480 VAC Delta ...		<p>20PSP ...DG11...(3W+G)</p>		
120/240 VAC Hi-leg delta 240/480 VAC Hi-leg delta ...	<p>20PSP ...HN11...(4W+G, L2 is High leg)</p>	<p>20PSP ...HG11...(4W+G, L2 is High leg)</p>		



PSP F series panel SPDs are extra compact UL Type 1 SPD with nominal discharge current up to 20kA, designed to protect single phase and multi-phase electrical distribution systems against the harmful effects of transient surges. They are constructed with Prosurge's PTMOV which has a significant advantage in abnormal over-voltage & high fault current safety and thus ensure industry's highest level of safety and performance. They are tested and listed as Type 1 SPD, ANSI/UL1449 5th, CSA C22.2.



PSP Category	F
Certification	ANSI/UL1449 5th, CSA C22.2, Type1
Connection Type	Parallel Connected
Surge Capacity	50kA per Phase
Nominal Discharge Current In	20kA
SCCR	200kArms
Power Status Indication	Normal= LED ON
Working Status Indication	Fail= LED OFF
Power Connecting	10AWG (L1=black; L2=red; L3=blue; N=white; PE=green)
Working Environments	Temperature -40°C+75°C, Humidity relative 5~95% (25°C) , Altitude≤3km
Dimensions, W x D x H	68x68x85mm
Enclosure	Waterproof plastic enclosure
Threaded NPT	3/4"NPT
Net Weight (Typical Value)	0.4 kg

• Dimension drawing

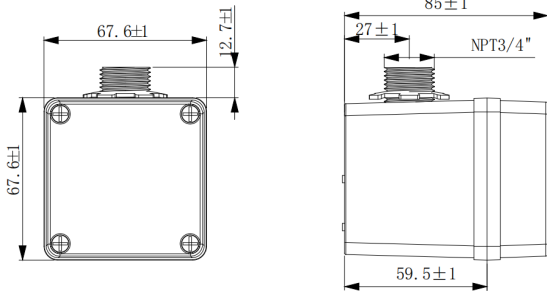

**Typical Application:**

In low & medium exposure locations

- Commercial
- Industrial
- Home solution
- Communications
- Renewable energy

**PSP F (In :20kA) - Technical Data:**

Model No.	System Voltage (50/60Hz)	In (kA)	Protected Mode				Voltage Protection Ratings (VPR @6kV/ 3kA,V)				Surge Capacity per phase	MCOV (Vac)
			L-N	L-G	N-G	L-L	L-N	L-G	N-G	L-L		
PSPF120SPNN11/T1	120/240V Split-phase	20	✓	✗	✗	✓	700	-	-	1200	50kA	150/300
PSPF120SPCG11/T1		20	✗	✓	✗	✓	-	700	-	1200	50kA	150/300
PSPF120SPG11/T1		20	✗	✓	✓	✓	-	700	700	1200	50kA	150/300
PSPF120SPN11/T1		20	✓	✗	✓	✓	700	-	700	1200	50kA	150/300
PSPF240SPNN11/T1	240/480V Split-phase	20	✓	✗	✗	✓	1200	-	-	2000	50kA	320/640
PSPF240SPCG11/T1		20	✗	✓	✗	✓	-	1200	-	2000	50kA	320/640
PSPF240SPG11/T1		20	✗	✓	✓	✓	-	1200	1200	2000	50kA	320/640
PSPF240SPN11/T1		20	✓	✗	✓	✓	1200	-	1200	2000	50kA	320/640
PSPF120YG11/T1	208Y120V Three-phase wye	20	✗	✓	✓	✓	-	700	700	1200	50kA	150
PSPF120YN11/T1		20	✓	✗	✓	✓	700	-	700	1200	50kA	150
PSPF120YCG11/T1		20	✗	✓	✗	✓	-	700	-	1200	50kA	150
PSPF120YNN11/T1		20	✓	✗	✗	✓	700	-	-	1200	50kA	150
PSPF127YG11/T1	220Y127V Three-phase wye	20	✗	✓	✓	✓	-	700	700	1200	50kA	150
PSPF127YN11/T1		20	✓	✗	✓	✓	700	-	700	1200	50kA	150
PSPF127YCG11/T1		20	✗	✓	✗	✓	-	700	-	1200	50kA	150
PSPF127YNN11/T1		20	✓	✗	✗	✓	700	-	-	1200	50kA	150
PSPF240YG11/T1	415Y/240V Three-phase wye	20	✗	✓	✓	✓	-	1200	1200	2000	50kA	320
PSPF240YN11/T1		20	✓	✗	✓	✓	1200	-	1200	2000	50kA	320
PSPF240YCG11/T1		20	✗	✓	✗	✓	-	1200	-	2000	50kA	320
PSPF240YNN11/T1		20	✓	✗	✗	✓	1200	-	-	2000	50kA	320



**PSP F (In :20kA) - Technical Data:**

Model No.	System Voltage (50/60Hz)	In (kA)	Protected Mode				Voltage Protection Ratings (VPR @6kV/ 3kA,V)				Surge Capacity per phase	MCOV (Vac)
			L-N	L-G	N-G	L-L	L-N	L-G	N-G	L-L		
PSPF277YG11/T1	480Y/277V Three-phase wye	20	x	✓	✓	✓	-	1200	1200	2000	50kA	320
PSPF277YN11/T1		20	✓	x	✓	✓	1200	-	1200	2000	50kA	320
PSPF277YCG11/T1		20	x	✓	x	✓	-	1200	-	2000	50kA	320
PSPF277YNN11/T1		20	✓	x	x	✓	1200	-	-	2000	50kA	320
PSPF347YG11/T1	600Y347V Three-phase wye	20	x	✓	✓	✓	-	1500	1500	2500	50kA	420
PSPF347YN11/T1		20	✓	x	✓	✓	1500	-	1500	2500	50kA	420
PSPF347YCG11/T1		20	x	✓	x	✓	-	1500	-	2500	50kA	420
PSPF347YNN11/T1		20	✓	x	x	✓	1500	-	-	2500	50kA	420
PSPF120HG11/T1	120/240V High leg delta	20	x	✓	✓	✓	-	700-1200HL	700	1200-2000HL	50kA	150/320(HL)
PSPF120HN11/T1		20	✓	x	✓	✓	700-1200HL	-	700	1200-2000HL	50kA	150/320(HL)
PSPF240HG11/T1	240/480V High leg delta	20	x	✓	✓	✓	-	1200-1800HL	1200	2000-3000HL	50kA	320/550(HL)
PSPF240HN11/T1		20	✓	x	✓	✓	1200-1800HL	1200-1800HL	1200	2000-3000HL	50kA	320/550(HL)
PSPF240DG11/T1	240V Three-phase delta	20	x	✓	x	✓	-	1200	-	1200	50kA	320
PSPF480DG11/T1	480V Three-phase delta	20	x	✓	x	✓	-	1800	-	3000	50kA	550
PSPF120SG11/T1	120V Single-phase	20	x	✓	✓	x	-	700	700	-	50kA	150
PSPF120SN11/T1		20	✓	x	✓	x	700	-	700	-	50kA	150
PSPF127SG11/T1	127V Single-phase	20	x	✓	✓	x	-	700	700	-	50kA	150
PSPF127SN11/T1		20	✓	x	✓	x	700	-	700	-	50kA	150
PSPF240SG11/T1	240V Single-phase	20	x	✓	✓	x	-	1200	1200	-	50kA	320
PSPF240SN11/T1		20	✓	x	✓	x	1200	-	1200	-	50kA	320
PSPF277SG11/T1	277V Single-phase	20	x	✓	✓	x	-	1200	1200	-	50kA	320
PSPF277SN11/T1		20	✓	x	✓	x	1200	-	1200	-	50kA	320
PSPF347SG11/T1	347V Single-phase	20	x	✓	✓	x	-	1500	1500	-	50kA	420
PSPF347SN11/T1		20	✓	x	✓	x	1500	-	1500	-	50kA	420





**PSP F (In :20kA ) - Basic Circuit Diagram**

Un/ Power system (50/60 HZ)		Basic Surge Protection Circuit Diagram	
120/240 VAC split phase	PSPF...SPN11...(3W+G)		PSPF...SPN11...(3W)
240/480 VAC split phase	PSPF...SPG11...(3W+G)		PSPF...SPCG11...(2W+G)
...			
120 VAC single phase	PSPF...SN11...(2W+G)		PSPF...YCG11...(3W+G)
127 VAC single phase			
230 VAC single phase			
240 VAC single phase			
277 VAC single phase			
347 VAC single phase			
...			
120/208 VAC WYE	PSPF...YN11...(4W+G)		PSPF...YNN11...(4W)
127/220 VAC WYE			
230/400 VAC WYE			
240/415VAC WYE			
277/480 VAC WYE			
347/600 VAC WYE			
...			
240 VAC Delta	PSPF...DG11...(3W+G)		
480 VAC Delta			
600 VAC Delta			
...			
120/240 VAC Hi-leg delta	PSPF...HN11...(4W+G, L2 is High leg)		PSPF...HG%1...(4W+G, L2 is High leg)
240/480 VAC Hi-leg delta			
...			



Prosurge PSP C series panel SPDs are defined as high performance surge protection solution for most commercial and industrial environments with critical operations. They include Type 1 and Type2 SPDs that protect against the harmful effects of transient surges.

**Typical Application:**

In medium & high exposure locations

- Commercial
- Industrial
- Communications
- Renewable energy
- Critical power (hospitals, data centers, etc.)

PSP Category	C1	C2	HPSP
Certification	ANSI / UL 1449 5th, UL1283, CSA C22.2, Type 1, Type 2		
Connection Type	Parallel Connected		
Surge Capacity	100~300kA	100~300kA	400~600kA
SCCR	200kArms		
UL1283 EMI / RFI filter	Sine wave tracking, up to -45dB from 10kHz to 100MHz (Type 2 only)		
Lightning Counter Current	≥ 200A (with Reset button )		
Failure Pre-Test	Press 2S (test button)		
Power Status Indication	Normal = Power LED ON		
Working Status Indication	Normal = Power LED ON; Fail=Blue LED turn to Red		
Power Connecting	10 AWG (L1=black; L2=red; L3=blue; N=white; PE=green)		
Signal Cable (Remote Alarm)	16 AWG (C=red; NC=blue; NO=brown)		
Working Environment	Temperature: -40°C~+75°C; Humidity relative 5~95% (25°C); Altitude: ≤3km		
Dimension, WxDxH	232x150x106 mm	286x200x120 mm	232x150x106 mm
Threaded NPT	3/4" NPT		
Enclosure	Waterproof plastic enclosure	Waterproof metal enclosure	Waterproof plastic enclosure
Net Weight (Typical Value)	1.59kg	4.3Kg	1.8Kg

**C1/HPSP: Waterproof plastic enclosure**



- Dimension drawing

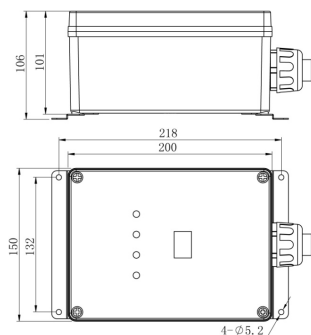

**C2: Waterproof metal enclosure**



- Dimension drawing

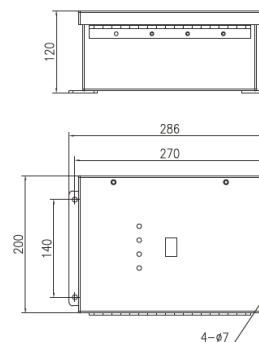



**PSP C - Technical Data:**

Note: % means 2 to 6 (Surge capacity 100kA~300kA per phase)

Model No.	System Voltage (50/60Hz)	In (kA)	Protected Mode				Voltage Protection Ratings (VPR @6kV/ 3kA,V)				Surge Capacity per phase	MCOV (Vac)
			L-N	L-G	N-G	L-L	L-N	L-G	N-G	L-L		
PSP120SP%2/*CTA	120/240V Split-phase	20	✓	✓	✓	✓	600	700	700	1200	100~300kA	150/300
PSP120SPC%2/*CTA	120/240V Split-phase No neutral	20	✗	✓	✗	✓	-	700	-	1200	100~300kA	150/300
PSP240SP%2/*CTA	240/480V Split-phase	20	✓	✓	✓	✓	1200	1200	1200	2000	100~300kA	320/640
PSP240SPC%2/*CTA	240/480V Split-phase No neutral	20	✗	✓	✗	✓	-	1200	-	2000	100~300kA	320/640
PSP120Y%2/*CTA	208Y120V Three-phase wye	20	✓	✓	✓	✓	600	700	700	1200	100~300kA	150
PSP120YC%2/*CTA	208Y120V Three-phase wye No neutral	20	✗	✓	✗	✓	-	700	-	1200	100~300kA	150
PSP127Y%2/*CTA	220Y127V Three-phase wye	20	✓	✓	✓	✓	600	700	700	1200	100~300kA	150
PSP127YC%2/*CTA	220Y127V Three-phase wye No neutral	20	✗	✓	✗	✓	-	700	-	1200	100~300kA	150
PSP240Y%2/*CTA	415Y240V Three-phase wye	20	✓	✓	✓	✓	1200	1200	1200	2000	100~300kA	320
PSP240YC%2/*CTA	415Y240V Three-phase wye No neutral	20	✗	✓	✗	✓	-	1200	-	2000	100~300kA	320
PSP277Y%2/*CTA	480Y277V Three-phase wye	20	✓	✓	✓	✓	1200	1200	1200	2000	100~300kA	320
PSP277YC%2/*CTA	480Y277V Three-phase wye No neutral	20	✗	✓	✗	✓	-	1200	-	2000	100~300kA	320
PSP347Y%2/*CTA	600Y347V Three-phase wye	20	✓	✓	✓	✓	1500	1500	1500	2500	100~300kA	420
PSP347YC%2/*CTA	600Y347V Three-phase wye No neutral	20	✗	✓	✗	✓	-	1500	-	2500	100~300kA	420
PSP120H%2/*CTA	120/240V High-leg delta	20	✓	✓	✓	✓	600-1200HL	700-1200HL	700	1200-2000HL	100~300kA	150/320(HL)
PSP120HC%2/*CTA	120/240V High-leg delta No neutral	20	✗	✓	✗	✓	-	700-1200HL	-	1200-2000HL	100~300kA	150/320(HL)
PSP240H%2/*CTA	240/480V High-leg delta	20	✓	✓	✓	✓	1200-1800HL	1200-1800HL	1200	2000-3000HL	100~300kA	320/550(HL)
PSP240HC%2/*CTA	240/480V High-leg delta No neutral	20	✗	✓	✗	✓	-	1200-1800HL	-	2000-3000HL	100~300kA	320/550(HL)
PSP240D%2/*CTA	240V Three-phase delta	20	✗	✓	✗	✓	-	1200	-	1200	100~300kA	320
PSP480D%2/*CTA	480V Three-phase delta	20	✗	✓	✗	✓	-	1800	-	2000	100~300kA	550
PSP600D%2/*CTA	600V Three-phase delta	20	✗	✓	✗	✓	-	2000	-	2500	100~300kA	690
PSP120S%2/*CTA	120V Single-phase	20	✓	✓	✓	✗	600	700	700	-	100~300kA	150
PSP127S%2/*CTA	127V Single-phase	20	✓	✓	✓	✗	600	700	700	-	100~300kA	150
PSP240S%2/*CTA	240V Single-phase	20	✓	✓	✓	✗	1200	1200	1200	-	100~300kA	320
PSP277S%2/*CTA	277V Single-phase	20	✓	✓	✓	✗	1200	1200	1200	-	100~300kA	320
PSP347S%2/*CTA	347V Single-phase	20	✓	✓	✓	✗	1500	1500	1500	-	100~300kA	420



**HPSP - Technical Data:**

Note: % means 4 to 6 (surge capacity 400kA~600kA per phase)

Model No.	System Voltage (50/60Hz)	In (kA)	Protected Mode				Voltage Protection Ratings (VPR @6kV/ 3kA, V)				Surge Capacity per phase	MCOV (Vac)
			L-N	L-G	N-G	L-L	L-N	L-G	N-G	L-L		
HPSP120SP%2/*CTA	120/240V Split-phase	20	✓	✓	✓	✓	600	700	700	1200	400~600kA	150/300
HPSP120SPC%2/*CTA	120/240V Split-phase No neutral	20	✗	✓	✗	✓	-	700	-	1200	400~600kA	150/300
HPSP240SP%2/*CTA	240/480V Split-phase	20	✓	✓	✓	✓	1200	1200	1200	2000	400~600kA	320/640
HPSP240SPC%2/*CTA	240/480V Split-phase No neutral	20	✗	✓	✗	✓	-	1200	-	2000	400~600kA	320/640
HPSP127Y%2/*CTA	220Y127V Three-phase wye	20	✓	✓	✓	✓	600	700	700	1200	400~600kA	150
HPSP127YC%2/*CTA	220Y127V Three-phase wye No neutral	20	✗	✓	✗	✓	-	700	-	1200	400~600kA	150
HPSP240Y%2/*CTA	415Y240V Three-phase wye	20	✓	✓	✓	✓	1200	1200	1200	2000	400~600kA	320
HPSP240YC%2/*CTA	415Y240V Three-phase wye No neutral	20	✗	✓	✗	✓	-	1200	-	2000	400~600kA	320
HPSP277Y%2/*CTA	480Y277V Three-phase wye	20	✓	✓	✓	✓	1200	1200	1200	2000	400~600kA	320
HPSP277YC%2/*CTA	480Y277V Three-phase wye No neutral	20	✗	✓	✗	✓	-	1200	-	2000	400~600kA	320
HPSP347Y%2/*CTA	600Y347V Three-phase wye	20	✓	✓	✓	✓	1500	1500	1500	2500	400~600kA	420
HPSP347YC%2/*CTA	600Y347V Three-phase wye No neutral	20	✗	✓	✗	✓	-	1500	-	2500	400~600kA	420
HPSP120H%2/*CTA	120/240V High-leg delta	20	✓	✓	✓	✓	600-1200HL	700-1200HL	700	1200-2000HL	400~600kA	150/320(HL)
HPSP120HC%2/*CTA	120/240V High-leg delta No neutral	20	✗	✓	✗	✓	-	700-1200HL	-	1200-2000HL	400~600kA	150/320(HL)
HPSP240H%2/*CTA	240/480V High-leg delta	20	✓	✓	✓	✓	1200-1800HL	1200-1800HL	1200	2000-3000HL	400~600kA	320/550(HL)
HPSP240HC%2/*CTA	240/480V High-leg delta No neutral	20	✗	✓	✗	✓	-	1200-1800HL	-	2000-3000HL	400~600kA	320/550(HL)
HPSP240D%2/*CTA	240V Three-phase delta	20	✗	✓	✗	✓	-	1200	-	1200	400~600kA	320
HPSP480D%2/*CTA	480V Three-phase delta	20	✗	✓	✗	✓	-	1800	-	2000	400~600kA	550
HPSP127S%2/*CTA	127V Single-phase	20	✓	✓	✓	✗	600	700	700	-	400~600kA	150
HPSP277S%2/*CTA	277V Single-phase	20	✓	✓	✓	✗	1200	1200	1200	-	400~600kA	320
HPSP347S%2/*CTA	347V Single-phase	20	✓	✓	✓	✗	1500	1500	1500	-	400~600kA	420





**PSP C - Basic Circuit Diagram**

Un/ Power System (50/60 HZ)	Basic Surge Protection Circuit Diagram	
	Power System with Neutral Line	Power System without Neutral Line
120/240VAC split phase 240/480VAC split phase ...	(H)PSP...SP%2...(3W+G) 	(H)PSP...SPC%2...(2W+G) 
120VAC single phase 127VAC single phase 220VAC single phase 230VAC single phase 240VAC single phase 277VAC single phase 347VAC single phase ...	(H)PSP...S%2...(2W+G) 	
120/208VAC WYE 127/220VAC WYE 220/380VAC WYE 230/400VAC WYE 240/415VAC WYE 277/480VAC WYE 347/600VAC WYE ...	(H)PSP...Y%2...(4W+G) 	(H)PSP...YC%2...(3W+G) 
240VAC Delta 480VAC Delta 600VAC Delta ...		(H)PSP...D%2...(3W+G) 
120/240VAC High-leg delta 240/480VAC High-leg delta ...	(H)PSP...H%2...(4W+G, L2 is High-leg) 	(H)PSP...HC%2...(3W+G, L2 is High-leg) 



# Panel SPDs | max. 900kA | Multi-phase **PS**

Prosurge PS series panel SPDs are ultra-large surge capacity design for critical application with very high exposure to lightning. They are UL 1449 5th Type 1 / Type 2 tested for point-of-entry (Category C, D, E, IEEE C62.41) and sub-circuit (Category B) protection. With surge capacity up to 900kA 8/20µs, PS series can meet most critical challenge worldwide and ensure maintenance-free for its lifetime.

By employing Prosurge's patented SMTMOV/HSMTMOV, a thermally protected and arc extinguishing technology component, PS series has a significant advantage in abnormal over-voltage & high fault current safety and thus ensure industry's highest level of safety and performance. The parallel redundancy modules design makes PS series more robust and reliable.

The **Anticipatory Failure Monitoring (AFM) technology** allows users to replace SPD before the protected electrical equipment or systems are threatened by overloads and thus ensure **uninterrupted surge protection**. Three stages LED indication (Blue-Yellow-Red) can help users to understand the current protection status. When the blue LED indicator turns to yellow, it shows that the SPD is in potential failure status and a replacement of the SPD is recommended. If the SPD is not replaced, it still continue to provide limited protection yet further overloads may lead to the risk of surge damage.

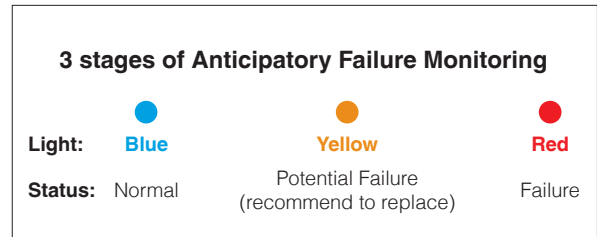

### Rating :

- **MCOV (Vac): 150V~690V**
- **Surge capacity (8/20µs): 150~600kA per phase, built with SMTMOV(I<sub>max</sub>:50kA) modules**  
**225~900kA per phase, built with HSMTMOV(I<sub>max</sub>:75kA) modules**
- **Lightning capacity (10/350µs): 12.5~80kA per phase, EN/IEC 61643-1/11 Class I test**
- **Short circuit current rating (SCCR): 200kArms - tested without external CB or fuse**

### Features:

- UL listed Type 1 (ANSI/UL1449 5th, CSA C22.2) SPDs
- UL listed Type 2 (ANSI/UL1449 5th, CSA C22.2) SPDs with sine wave tracking
- Prosurge patented SCCR 200kArms thermally protected MOV technology (SMTMOV/HSMTMOV) as key component
- Full modes protection & high surge energy capability with compact size
- Low voltage protection rating
- Failure indication. Anticipatory Failure Monitoring (AFM) technology to ensure permanent surge protection
- Surge event counter optional
- Sine wave tracking function optional
- Floating changeover contact for remote alarm
- Threaded NPT
- Waterproof metal enclosure to resist dirt, dust and water
- Meet both standards of UL1449 5th and IEC/EN 61643-11

### Typical Application:

In high exposure location, be ideal for primary service or building entrances protection applications:

- All power circuit
- Telecommunication application (cell towers, base station, data center, transfer center etc.)
- Industrial
- Commercial
- Renewable energy
- Oil or mineral



Adopt SMTMOV/HSMTMOV as Key Component





**Configuration & Ordering Information:**

PS	277Y	C	42	I	/ I1	CA
Model	Voltage and system configuration	Protection mode	Surge capacity	Gas tube optional	SPD Category	Additional function
<b>PS</b>	<b>120SP:</b> 120/240V split <b>240SP:</b> 240/480V split <b>120Y:</b> 120/208V WYE <b>277Y:</b> 277/480V WYE <b>120H:</b> 120/240V high-leg delta <b>240D:</b> 240V delta <b>120S:</b> 120V 1ph, 2W+G ...	<b>C:</b> Delete N-G protection mode  <b>G:</b> Only L/N (if needed) -G protection, delete L-N and L-L (if present ) protection  <b>N:</b> Only L-N & N-G protection, delete L-G protection  <b>N/A :</b> Full modes protection	31: 150 or 225 <sup>(1)</sup> kA /phase 41: 200 or 300 <sup>(1)</sup> kA /phase 51: 250 or 375 <sup>(1)</sup> kA /phase 61: 300 or 450 <sup>(1)</sup> kA /phase 32: 300 or 450 <sup>(1)</sup> kA /phase 42: 400 or 600 <sup>(1)</sup> kA /phase 52: 500 or 750 <sup>(1)</sup> kA /phase 62: 600 or 900 <sup>(1)</sup> kA /phase	<b>I:</b> Gas Tube used for N-G protection mode	<b>I1:</b> UL type 1 SPD  <b>I2F:</b> UL type 2 SPD with sine wave tracking	<b>C:</b> surge event counter  <b>A:</b> remote alarm

<sup>(1)</sup> The models with higher surge capacity are built with HSMTMOV (Uc range: 150~320)

PS Category	D
Certification	ANSI / UL 1449 5th, CSA C22.2, Type 1, Type 2
Connection Type	Parallel Connected
Surge Capacity	150~900kA per phase
SCCR	200kArms
Sine Wave Tracking	Optional for UL Type 2 listed
Lightning Counter Current	≥ 200A (with Reset button)
Failure Pre-Test	Press 2S (test button)
Power Status Indication	Normal=Blue LED ON
Working Status Indication	Three stage (Normal= Blue LED ON; Need replace= Yellow; Fail= turn to Red)
Power Connecting	8 AWG (L1=black; L2=red; L3=blue; N=white; PE=green)
Signal Cable	16 AWG (C=red; NC=blue; NO=brown)
Working Environment	Temperature: -40°C~+85°C; Humidity relative 5~95% (25°C); Altitude: ≤3km
Dimensions, W x D x H	350 x 370 x 223 mm
Threaded NPT	1" NPT
Enclosure	Waterproof metal enclosure
Net Weight (Typical Value)	10.6 kg

• Dimension drawing

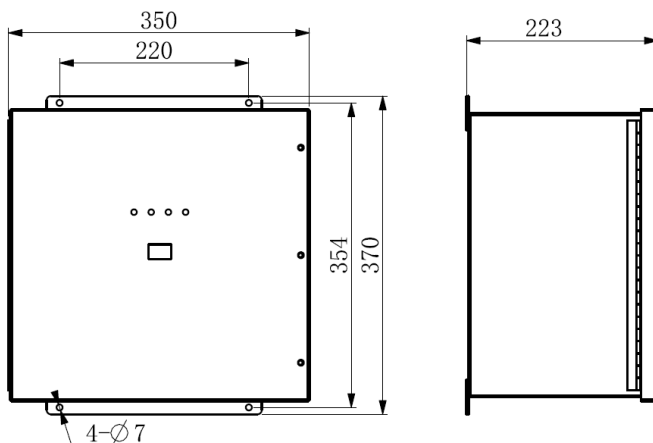



**PS series - Technical Data**

Note: % means 3 to 6 (Surge capacity 150kA~300kA per mode when SMMTOV is used, or 225kA~450kA when HSMTMOV is used)

<sup>(2)</sup> lightning capacity of NPE mode is 100kA 10/350µs

Model No.	System Voltage (50/60Hz)	In (kA)	Protected Mode				Voltage Protection Ratings (VPR @6kV/ 3kA.V)				Surge Capacity per phase (8/20µs)	Lightning Capacity per phase (10/350µs)	MCOV (Vac)
			L-N	L-G	N-G	L-L	L-N	L-G	N-G	L-L			
PS120SP%2/*CA	120/240V Split-phase	20	✓	✓	✓	✓	700	700	700	1200	300~900kA	25~80kA	150
PS120SPC%1/*CA			✗	✓	✗	✓	-	700	-	1200	150~450kA	12.5~40kA	150
PS120SPN%1T/*CA			✓	✓	✓	✓	700	1500	1500	1200	150~450kA	12.5~40kA <sup>(2)</sup>	150
PS240SP%2/*CA	240/480V Split-phase	20	✓	✓	✓	✓	1200	1200	1200	2000	300~900kA	25~80kA	320
PS240SPC%1/*CA			✗	✓	✗	✓	-	1200	-	2000	150~450kA	12.5~40kA	320
PS240SPN%1T/*CA			✓	✓	✓	✓	1200	2000	1500	2000	150~450kA	12.5~40kA <sup>(2)</sup>	320
PS120Y%2/*CA	208Y120V Three-phase wye	20	✓	✓	✓	✓	700	700	700	1200	300~900kA	25~80kA	150
PS120YN%1T/*CA			✓	✓	✓	✓	700	1500	1500	1200	150~450kA	12.5~40kA <sup>(2)</sup>	150
PS120YN%1/*CA			✓	✓	✓	✓	700	1200	700	1200	150~450kA	12.5~40kA	150
PS120YG%1/*CA			✓	✓	✓	✓	1200	700	700	1200	150~450kA	12.5~40kA	150
PS120YC%1/*CA			✗	✓	✗	✓	-	700	-	1200	150~450kA	12.5~40kA	150
PS127Y%2/*CA	220Y127V Three-phase wye	20	✓	✓	✓	✓	700	700	700	1200	300~900kA	25~80kA	150
PS127YN%1T/*CA			✓	✓	✓	✓	700	1500	1500	1200	150~450kA	12.5~40kA <sup>(2)</sup>	150
PS127YN%1/*CA			✓	✓	✓	✓	700	1200	700	1200	150~450kA	12.5~40kA	150
PS127YG%1/*CA			✓	✓	✓	✓	1200	700	700	1200	150~450kA	12.5~40kA	150
PS127YC%1/*CA			✗	✓	✗	✓	-	700	-	1200	150~450kA	12.5~40kA	150
PS230Y%2/*CA	400Y230V Three-phase wye	20	✓	✓	✓	✓	1200	1200	1200	2000	300~900kA	25~80kA	320
PS230YN%1T/*CA			✓	✓	✓	✓	1200	1500	1500	2000	150~450kA	12.5~40kA <sup>(2)</sup>	320
PS230YN%1/*CA			✓	✓	✓	✓	1200	2000	1200	2000	150~450kA	12.5~40kA	320
PS230YG%1/*CA			✓	✓	✓	✓	2000	1200	1200	2000	150~450kA	12.5~40kA	320
PS230YC%1/*CA			✗	✓	✗	✓	-	1200	-	2000	150~450kA	12.5~40kA	320
PS240Y%2/*CA	415Y240V Three-phase wye	20	✓	✓	✓	✓	1200	1200	1200	2000	300~900kA	25~80kA	320
PS240YN%1T/*CA			✓	✓	✓	✓	1200	1500	1500	2000	150~450kA	12.5~40kA <sup>(2)</sup>	320
PS240YN%1/*CA			✓	✓	✓	✓	1200	2000	1200	2000	150~450kA	12.5~40kA	320
PS240YG%1/*CA			✓	✓	✓	✓	2000	1200	1200	2000	150~450kA	12.5~40kA	320
PS240YC%1/*CA			✗	✓	✗	✓	-	1200	-	2000	150~450kA	12.5~40kA	320
PS277Y%2/*CA	480Y277V Three-phase wye	20	✓	✓	✓	✓	1200	1200	1200	2000	300~900kA	25~80kA	320
PS277YN%1/*CA			✓	✓	✓	✓	1200	2000	1200	2000	150~450kA	12.5~40kA	320
PS277YG%1/*CA			✓	✓	✓	✓	2000	1200	1200	2000	150~450kA	12.5~40kA	320
PS277YC%1/*CA			✗	✓	✗	✓	-	1200	-	2000	150~450kA	12.5~40kA	320
PS347Y%2/*CA	600Y347V Three-phase wye	20	✓	✓	✓	✓	1500	1500	1500	2500	300~600kA	25~80kA	420
PS347YN%1/*CA			✓	✓	✓	✓	1500	2500	1500	2500	150~300kA	12.5~40kA	420
PS347YG%1/*CA			✓	✓	✓	✓	2500	1500	1500	2500	150~300kA	12.5~40kA	420
PS347YC%1/*CA			✗	✓	✗	✓	-	1500	-	2500	150~300kA	12.5~40kA	420
PS120H%2/*CA	120/240V High-leg delta	20	✓	✓	✓	✓	700-1200HL	700-1200HL	700	1200-2000HL	300~900kA	25~80kA	150/320HL
PS120HN%1T/*CA			✓	✓	✓	✓	700-1200HL	1500-2000HL	1500	1200-2000HL	150~450kA	12.5~40kA <sup>(2)</sup>	150/320HL
PS120HN%1/*CA			✓	✓	✓	✓	700-1200HL	1200-2000HL	700	1200-2000HL	150~450kA	12.5~40kA	150/320HL
PS120HG%1/*CA			✓	✓	✓	✓	1200-2000HL	700-1200HL	700	1200-2000HL	150~450kA	12.5~40kA	150/320HL
PS120HC%1/*CA			✗	✓	✗	✓	-	700-1200HL	-	1200-2000HL	150~450kA	12.5~40kA	150/320HL





**PS series - Technical Data**

Model No.	System Voltage (50/60Hz)	In (kA)	Protected Mode				Voltage Protection Ratings (VPR @6kV/ 3kA,V)				Surge Capacity per phase (8/20µs)	Lightning Capacity per phase (10/350µs)	MCOV (Vac)
			L-N	L-G	N-G	L-L	L-N	L-G	N-G	L-L			
PS240H%2/*CA	240/480V High-leg delta	20	✓	✓	✓	✓	1200-2000HL	1200-2000HL	1200	2000-3000HL	300~600kA	25~50kA	320/550HL
PS240HN%1T/*CA			✓	✓	✓	✓	1200-2000HL	1500-3000HL	1500	2000-3000HL	150~300kA	12.5~25kA <sup>(2)</sup>	320/550HL
PS240HN%1/*CA			✓	✓	✓	✓	1200-2000HL	2000-3000HL	1200	2000-3000HL	150~300kA	12.5~25kA	320/550HL
PS240HG%1/*CA			✓	✓	✓	✓	2000-3000HL	1200-2000HL	1200	2000-3000HL	150~300kA	12.5~25kA	320/550HL
PS240HC%1/*CA			✗	✓	✗	✓	-	1200-2000HL	-	2000-3000HL	150~300kA	12.5~25kA	320/550HL
PS240D%2/*CA	240V Three-phase delta	20	✗	✓	✗	✓	-	1200	-	1200	300~900kA	25~80kA	320
PS240DG%1/*CA			✗	✓	✗	✓	-	1200	-	1500	150~450kA	12.5~40kA	320
PS480D%N2/*CA	480V Three-phase delta	20	✗	✓	✗	✓	-	1800	-	1800	300~600kA	25~50kA	550
PS480DGx1/*CA			✗	✓	✗	✓	-	1800	-	3000	150~300kA	12.5~25kA	550
PS600D%2/*CA	600V Three-phase delta	20	✗	✓	✗	✓	-	2000	-	2000	300~600kA	25~50kA	690
PS600DG%1/*CA			✗	✓	✗	✓	-	2000	-	4000	150~300kA	12.5~25kA	690
PS120S%2/*CA	120V Single-phase	20	✓	✓	✓	✗	700	700	700	-	300~900kA	25~40kA	150
PS120SN%1T/*CA			✓	✓	✓	✗	700	1500	1500	-	150~450kA	12.5~40kA <sup>(2)</sup>	150
PS120SN%1/*CA			✓	✓	✓	✗	700	1200	700	-	150~450kA	12.5~40kA	150
PS120SG%1/*CA			✓	✓	✓	✗	1200	700	700	-	150~450kA	12.5~40kA	150
PS127S%2/*CA	127V Single-phase	20	✓	✓	✓	✗	700	700	700	-	300~900kA	25~40kA	150
PS127SN%1T/*CA			✓	✓	✓	✗	700	1500	1500	-	150~450kA	12.5~40kA <sup>(2)</sup>	150
PS127SN%1/*CA			✓	✓	✓	✗	700	1200	700	-	150~450kA	12.5~40kA	150
PS127SG%1/*CA			✓	✓	✓	✗	1200	700	700	-	150~450kA	12.5~40kA	150
PS230S%2/*CA	230V Single-phase	20	✓	✓	✓	✗	1200	1200	1200	-	300~900kA	25~40kA	320
PS230SN%1T/*CA			✓	✓	✓	✗	1200	1500	1500	-	150~450kA	12.5~40kA <sup>(2)</sup>	320
PS230SN%1/*CA			✓	✓	✓	✗	1200	2000	1200	-	150~450kA	12.5~40kA	320
PS230SG%1/*CA			✓	✓	✓	✗	2000	1200	1200	-	150~450kA	12.5~40kA	320
PS240S%2/*CA	240V Single-phase	20	✓	✓	✓	✗	1200	1200	1200	-	300~900kA	25~40kA	320
PS240SN%1T/*CA			✓	✓	✓	✗	1200	1500	1500	-	150~450kA	12.5~40kA <sup>(2)</sup>	320
PS240SN%1/*CA			✓	✓	✓	✗	1200	2000	1200	-	150~450kA	12.5~40kA	320
PS240SG%1/*CA			✓	✓	✓	✗	2000	1200	1200	-	150~450kA	12.5~40kA	320
PS277S%2/*CA	277V Single-phase	20	✓	✓	✓	✗	1200	1200	1200	-	300~600kA	25~50kA	420
PS277SN%1/*CA			✓	✓	✓	✗	1200	2000	1200	-	150~300kA	12.5~25kA	420
PS277SG%1/*CA			✓	✓	✓	✗	2000	1200	1200	-	150~300kA	12.5~25kA	420
PS347S%2/*CA	347V Single-phase	20	✓	✓	✓	✗	1500	1500	1500	-	300~600kA	25~50kA	420
PS347SN%1/*CA			✓	✓	✓	✗	1500	2500	1500	-	150~300kA	12.5~25kA	420
PS347SG%1/*CA			✓	✓	✓	✗	2500	1500	1500	-	150~300kA	12.5~25kA	420



**PS Series - Basic Circuit Diagram**

Un/ Power system (50/60 HZ)	Basic Surge Protection Circuit Diagram		Basic Surge Protection Circuit Diagram	
	Normal model	N-G mode use GDT, Delete L-G mode (if present)	Delete L-G mode (if present)	Delete L-N or L-L mode (if present)
120/240VAC split phase 240/480VAC split phase ...				
120VAC single phase 127VAC single phase 220VAC single phase 230VAC single phase 240VAC single phase 277VAC single phase 347VAC single phase ...				
120/208VAC WYE 127/220VAC WYE 220/380VAC WYE 230/400VAC WYE 240/415VAC WYE 277/480VAC WYE 347/600VAC WYE ...				
240VAC Delta 480VAC Delta 600VAC Delta ...				
120/240VAC High-leg delta 240/480VAC High-leg delta ...				



POSP series plug-on SPDs are extra compact UL Type 1 SPD with nominal discharge current up to 20kA, designed to use in service entrance locations/load center/panel board to protect single phase against the harmful effects of transient surges. Plug-on design for universal 1-inch spaces single phase load center, the SPD is directly plugged on to the bus and requires two adjacent mounting spaces.

They are constructed with Prosurge's PTMOV which has a significant advantage in abnormal over-voltage & high fault current safety and thus ensure industry's highest level of safety and performance. They are tested and listed as Type 1 SPD, ANSI/UL1449 5th, CSA C22.2.



Model No.	POSP120SP20
Certification	ANSI/UL1449 5th, CSA C22.2, Type1
Power System (Un)	120/240V Split phase
Protection Mode	L-L, L-N
Surge Capacity	50kA per Phase
Nominal Discharge Current(In)	20kA
Maximum Continuous Operating Voltage ( MCOV )	L-N :150Vac, L-L:300Vac
Voltage Protection Rating (VPR)	L-N:600V, L-L:1000V
SCCR	200kArms
Power Status Indication	Normal= LED ON
Working Status Indication	Fail= LED OFF
Power Connecting	Plug-on to the bus
Installation Width	Two 1-inch poles
Enclosure	Waterproof plastic enclosure
Dimensions, W x D x H	50x74x65mm
Working Environments	Temperature -40°C+75°C, Humidity relative 5~95% (25°C) , Altitudes≤3km
Net Weight (Typical Value)	0.2 kg

- Dimension drawing

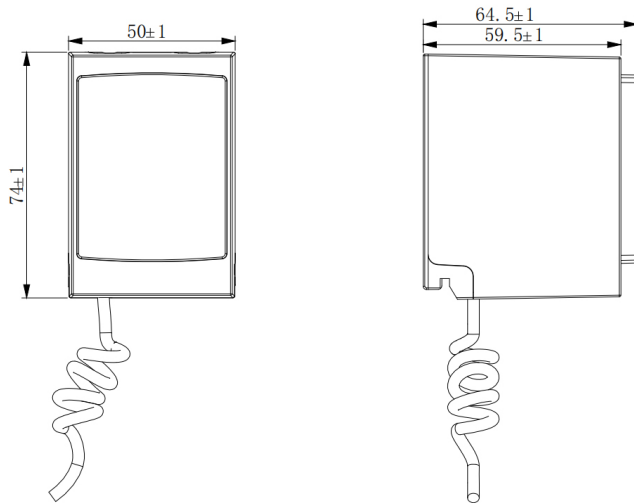

- Plug-on installation display

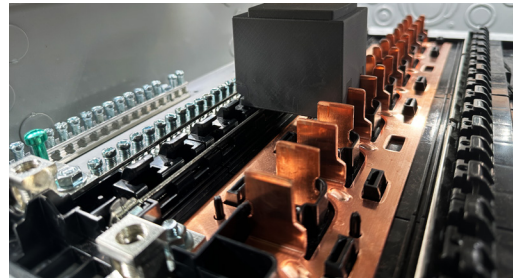



Prosurge SP series DIN-rail SPD is a Type 1CA SPD according to UL1449 5th, designed for low-voltage power supply system surge protection, especially for point of entry (Category C, D, ANSI/IEEE C62.41) and sub-circuit (Category B, ANSI/IEEE C62.41) protection.

### Rating:

- **MOCV (Vac): 150V~690V**
- **Max. discharge current (8/20us): 50kA**
- **Short circuit current rating (SCCR): 200kArms - tested without external CB or fuse**

### Features:

- UL recognized Type 1CA SPD per ANSI/UL 1449 5th and CSA C22.2 -UL file No. E319871, KEMA certified Class II (T2) SPD per IEC/EN 61643-11
- Low voltage protection level
- DIN-rail mounting configuration
- Failure indication and optional remote signal contact
- Pluggable module for easy replacement
- Meet both standards of UL1449 5th and IEC 61643-11
- Global patented thermal disconnecter design with arc extinguishing device, fail-safe & self-protected, quick thermal response and perfect circuit cutoff function. No additional over-current protection devices required



Single pole

Part No.		Pole	Max. Discharge Current, I <sub>max</sub> (8/20μs) (kA)	Nominal Discharge Current, I <sub>n</sub> (8/20μs) (kA)	Nominal Voltage (VAC)	Max. Continuous Operating Voltage, MCOV (VAC)	Voltage Protection Rating, VPR (kV)	SCCR Rating (kArms)
Type 1CA	Type 2CA							
SP150-S	SP150C-S	1	50	20	120	150	0.7	200
SP180-S	SP180C-S	1	50	20	127	180	1.0	200
SP275A-S	SP275AC-S	1	50	20	240	275	1.0	200
SP320-S	SP320C-S	1	50	20	277	320	1.2	200
SP385-S	SP385C-S	1	50	20	277	385	1.5	200
SP420-S	SP420C-S	1	50	20	347	420	1.5	200
SP550-S	SP550C-S	1	50	20	480	550	1.8	200
SP690-S	SP690C-S	1	40	20	600	690	2.5	200
SP150T-S	SP150TC-S	1	50	20	Neutral	150	0.9	200
SP255T-S	SP255TC-S	1	50	20	Neutral	255	0.9	200

- Dimension drawing

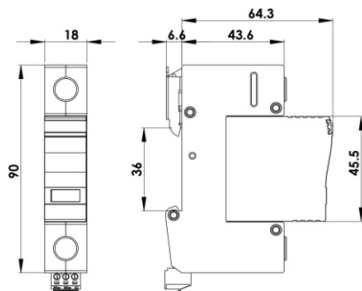

- Basic circuit diagram

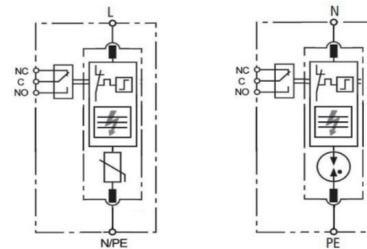

L-N/PE (1P)

N-PE (1P)



**Single-phase**  
**Two-wire + Ground**

Part No.		Pole	Max. Discharge Current, I <sub>max</sub> (8/20μs) (kA)	Nominal Discharge Current, I <sub>n</sub> (8/20μs) (kA)	Nominal Voltage (VAC)	Max. Continuous Operating Voltage, MCOV (VAC)			Voltage Protection Rating, VPR (kV)			SCCR Rating (kArms)
Type 1CA	Type 2CA					L-N	L-G	N-G	L-N	L-G	N-G	
SP150/2P-S	SP150C/2P-S	2	50	20	120V	-	150	150	-	0.7	0.7	200
SP150/PN-S*	SP150C/PN-S*	2	50	20	120V	150	-	150*	0.7	-	0.9	200
SP180/2P-S	SP180C/2P-S	2	50	20	127V	-	180	180	-	1.0	1.0	200
SP180/PN-S*	SP180C/PN-S*	2	50	20	127V	180	-	150*	1.0	-	0.9	200
SP275A/2P-S	SP275AC/2P-S	2	50	20	230V	-	275	275	-	1.0	1.0	200
SP275A/PN-S*	SP275AC/PN-S*	2	50	20	230V	275	-	255*	1.0	-	0.9	200
SP320/2P-S	SP320C/2P-S	2	50	20	240V	-	320	320	-	1.2	1.2	200
SP320/PN-S*	SP320C/PN-S*	2	50	20	240V	320	-	255*	1.2	-	0.9	200
SP385/2P-S	SP385C/2P-S	2	50	20	277V	-	385	385	-	1.5	1.5	200
SP385/PN-S*	SP385C/PN-S*	2	50	20	277V	385	-	255*	1.5	-	0.9	200
SP420/2P-S	SP420C/2P-S	2	50	20	347V	-	420	420	-	1.5	1.5	200
SP420/PN-S*	SP420C/PN-S*	2	50	20	347V	420	-	255*	1.5	-	0.9	200

\* PN : GDT Module for N-PE pole

• Dimension drawing

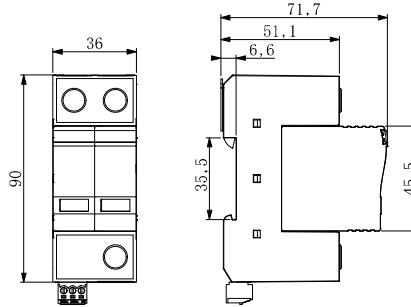

• Basic circuit diagram

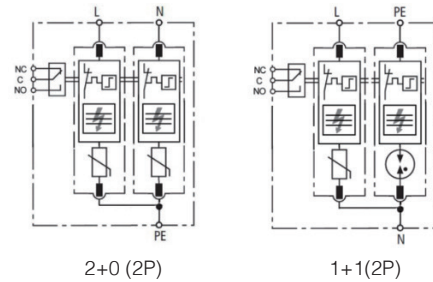

**Split-phase**  
**Three-wire**

Part No.		Pole	Max. Discharge Current, I <sub>max</sub> (8/20μs) (kA)	Nominal Discharge Current, I <sub>n</sub> (8/20μs) (kA)	Nominal Voltage (VAC)	Max. Continuous Operating Voltage, MCOV (VAC)			Voltage Protection Rating, VPR (kV)			SCCR Rating (kArms)
Type 1CA	Type 2CA					L-N	L-G	N-G	L-N	L-G	N-G	
SP150/2SPN-S	SP150C/2SPN-S	2	50	20	120/240V	150	-	-	0.7	-	-	200
SP180/2SPN-S	SP180C/2SPN-S	2	50	20	120/240V	180	-	-	1.0	-	-	200
SP320/2SPN-S	SP320C/2SPN-S	2	50	20	240/480V	320	-	-	1.2	-	-	200

• Dimension drawing

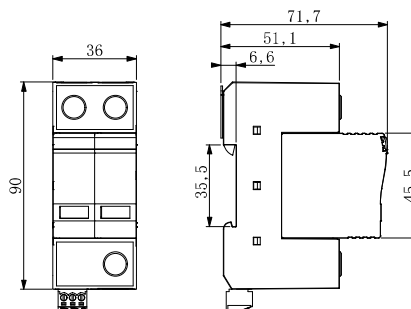

• Basic circuit diagram

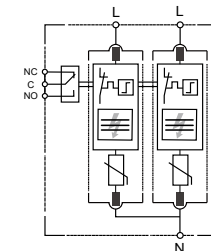





Part No.		Pole	Max. Discharge Current, I <sub>max</sub> (8/20μs) (kA)	Nominal Discharge Current, I <sub>n</sub> (8/20μs) (kA)	Nominal Voltage (VAC)	Max. Continuous Operating Voltage, MCOV (VAC)			Voltage Protection Rating, VPR (kV)			SCCR Rating (kArms)
Type 1CA	Type 2CA					L-N	L-G	N-G	L-N	L-G	N-G	
SP150/2SPG-S	SP150C/2SPG-S	2	50	20	120/240V	-	150	-	-	0.7	-	200
SP180/2SPG-S	SP180C/2SPG-S	2	50	20	120/240V	-	180	-	-	1.0	-	200
SP320/2SPG-S	SP320C/2SPG-S	2	50	20	240/480V	-	320	-	-	1.2	-	200

**Split-phase**  
Two-wire + Ground

- Dimension drawing

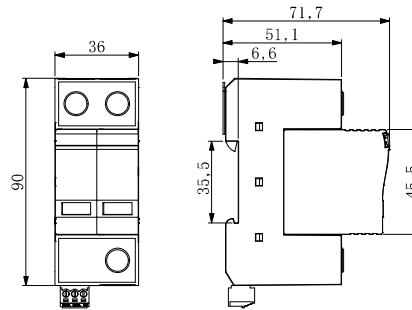

- Basic circuit diagram

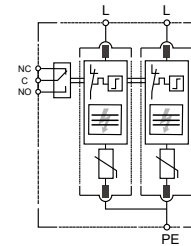

Part No.		Pole	Max. Discharge Current, I <sub>max</sub> (8/20μs) (kA)	Nominal Discharge Current, I <sub>n</sub> (8/20μs) (kA)	Nominal Voltage (VAC)	Max. Continuous Operating Voltage, MCOV (VAC)			Voltage Protection Rating, VPR (kV)			SCCR Rating (kArms)
Type 1CA	Type 2CA					L-N	L-G	N-G	L-N	L-G	N-G	
SP150/3SP-S	SP150C/3SP-S	3	50	20	120/240V	150	-	150	0.7	-	0.7	200
SP180/3SP-S	SP180C/3SP-S	3	50	20	120/240V	180	-	180	1.0	-	1.0	200
SP320/3SP-S	SP320C/3SP-S	3	50	20	240/480V	320	-	320	1.2	-	1.2	200

**Split-phase**  
Three-wire + Ground

- Dimension drawing

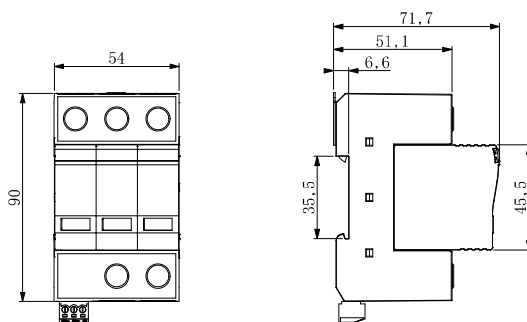

- Basic circuit diagram

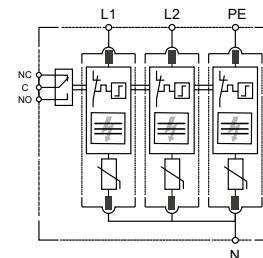



**Three-phase WYE**  
Three-wire + Ground

Part No.		Pole	Max. Discharge Current, I <sub>max</sub> (8/20μs) (kA)	Nominal Discharge Current, I <sub>n</sub> (8/20μs) (kA)	Nominal Voltage (VAC)	Max. Continuous Operating Voltage, MCOV (VAC)			Voltage Protection Rating, VPR (kV)			SCCR Rating (kArms)
Type 1CA	Type 2CA					L-N	L-G	N-G	L-N	L-G	N-G	
SP150/3P-S	SP150C/3P-S	3	50	20	208Y/120V	-	150	-	-	0.7	-	200
SP180/3P-S	SP180C/3P-S	3	50	20	220Y/127V	-	180	-	-	1.0	-	200
SP275A/3P-S	SP275AC/3P-S	3	50	20	400Y/230V	-	275	-	-	1.0	-	200
SP320/3P-S	SP320C/3P-S	3	50	20	415Y/240V	-	320	-	-	1.2	-	200
SP385/3P-S	SP385C/3P-S	3	50	20	480Y/277V	-	385	-	-	1.5	-	200
SP420/3P-S	SP420C/3P-S	3	50	20	600Y/347V	-	420	-	-	1.5	-	200
SP550/3P-S	SP550C/3P-S	3	50	20	600Y/347V	-	550	-	-	1.8	-	200

• Dimension drawing

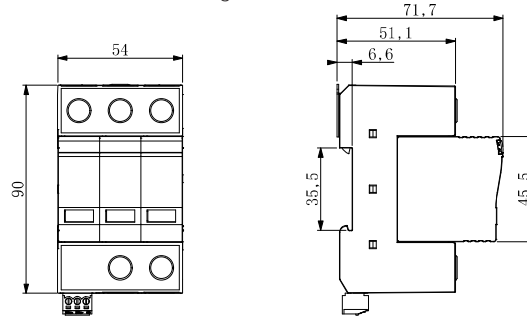

• Basic circuit diagram

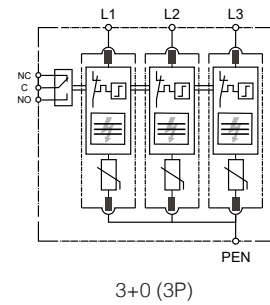

**Three-phase Delta**  
Three-wire + Ground

Part No.		Pole	Max. Discharge Current, I <sub>max</sub> (8/20μs) (kA)	Nominal Discharge Current, I <sub>n</sub> (8/20μs) (kA)	Nominal Voltage (VAC)	Max. Continuous Operating Voltage, MCOV (VAC)			Voltage Protection Rating, VPR (kV)			SCCR Rating (kArms)
Type 1CA	Type 2CA					L-N	L-G	N-G	L-N	L-G	N-G	
SP320/3D-S	SP320C/3D-S	3	50	20	240V	-	320	-	-	1.2	200	
SP550/3D-S	SP550C/3D-S	3	50	20	480V	-	550	-	-	1.8	200	
SP690/3D-S	SP690C/3D-S	3	40	20	600V	-	690	-	-	2.5	200	

• Dimension drawing

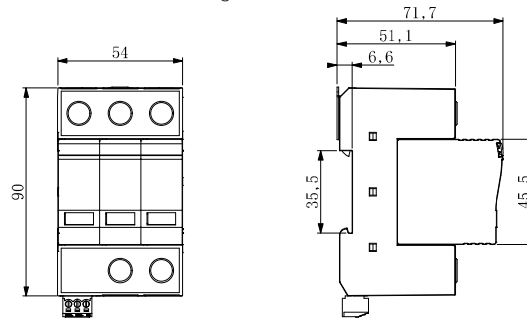

• Basic circuit diagram

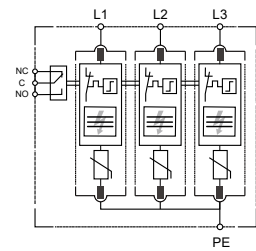



**Three-phase WYE**  
**Four-wire + Ground**

Part No.		Pole	Max. Discharge Current, I <sub>max</sub> (8/20μs) (kA)	Nominal Discharge Current, I <sub>n</sub> (8/20μs) (kA)	Nominal Voltage (VAC)	Max. Continuous Operating Voltage, MCOV (VAC)			Voltage Protection Rating, VPR (kV)			SCCR Rating (kArms)
Type 1CA	Type 2CA					L-N	L-G	N-G	L-N	L-G	N-G	
SP150/4P-S	SP150C/4P-S	4	50	20	208Y/120V	-	150	150	-	0.7	0.7	200
SP150/3PN-S*	SP150C/3PN-S*	4	50	20	208Y/120V	150	-	150*	0.7	-	0.9	200
SP180/4P-S	SP180C/4P-S	4	50	20	220Y/127V	-	180	180	-	1.0	1.0	200
SP180/3PN-S*	SP180C/3PN-S*	4	50	20	220Y/127V	180	-	150*	1.0	-	0.9	200
SP275A/4P-S	SP275AC/4P-S	4	50	20	400Y/230V	-	275	275	-	1.0	1.0	200
SP275A/3PN-S*	SP275AC/3PN-S*	4	50	20	400Y/230V	275	-	255*	1.0	-	0.9	200
SP320/4P-S	SP320C/4P-S	4	50	20	415Y/240V	-	320	320	-	1.2	1.2	200
SP320/3PN-S*	SP320C/3PN-S*	4	50	20	415Y/240V	320	-	255*	1.2	-	0.9	200
SP385/4P-S	SP385C/4P-S	4	50	20	480Y/277V	-	385	385	-	1.5	1.5	200
SP385/3PN-S*	SP385C/3PN-S*	4	50	20	480Y/277V	385	-	255*	1.5	-	0.9	200
SP420/4P-S	SP420C/4P-S	4	50	20	600Y/347V	-	420	420	-	1.5	1.5	200
SP420/3PN-S*	SP420C/3PN-S*	4	50	20	600Y/347V	420	-	255*	1.5	-	0.9	200

\* PN : GDT Module for N-PE pole

• Dimension drawing

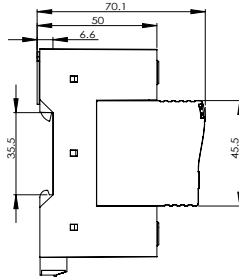
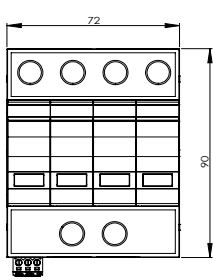

• Basic circuit diagram

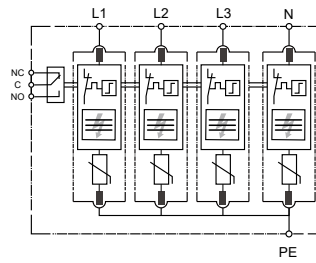

4+0 (4P)

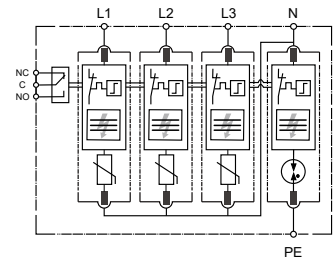

3+1 (4P)



**Three-phase Hi-Leg Delta**  
**Four-wire + Ground**

Part No.		Pole	Max. Discharge Current, I <sub>max</sub> (8/20μs) (kA)	Nominal Discharge Current, I <sub>n</sub> (8/20μs) (kA)	Nominal Voltage (VAC)	Max. Continuous Operating Voltage, MCOV (VAC)			Voltage Protection Rating, VPR (kV)			SCCR Rating (kArms)
Type 1CA	Type 2CA					L-N	L-G	N-G	L-N	L-G	N-G	
SP240/3H-S	SP240C/3H-S	4	50	20	240H/120V	150 320(HL)	-	150	0.7 1.2(HL)	-	0.7	200
SP480/3H-S	SP480C/3H-S	4	50	20	480H/240V	320 550(HL)	-	320	1.2 1.8(HL)	-	1.2	200

• Dimension drawing

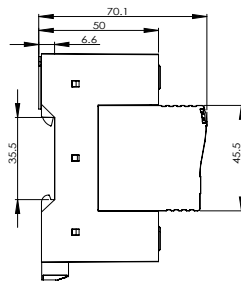
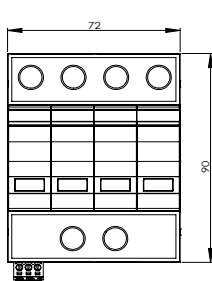

• Basic circuit diagram

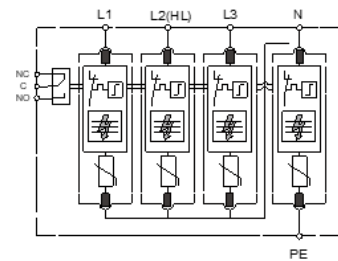



**Accessory for SP series**  
**Plug-in protection module**



Part No		Module Type	Max. Discharge Current, I <sub>max</sub> (8/20μs) (kA)	Nominal Discharge Current, I <sub>n</sub> (8/20μs) (kA)	Max. Continuous Operating Voltage, MCOV (VAC)	Voltage Protection Rating, VPR (kV)	SCCR Rating (kArms)
Type 1CA	Type 2CA						
MSP150	MSP150C	MOV	50	20	150	0.7	200
MSP180	MSP180C	MOV	50	20	180	1.0	200
MSP275A	MSP275AC	MOV	50	20	275	1.0	200
MSP320	MSP320C	MOV	50	20	320	1.2	200
MSP385	MSP385C	MOV	50	20	385	1.5	200
MSP420	MSP420C	MOV	50	20	420	1.5	200
MSP550	MSP550C	MOV	50	20	550	1.8	200
MSP690	MSP690C	MOV	40	20	690	2.5	200
MSP150T	MSP150TC	GDT	50	20	150	0.9	200
MSP255T	MSP255TC	GDT	50	20	255	0.9	200



### Rating:

- MCOV (Vac): 150V~420V
- Max. discharge current (8/20us): 75kA
- Short circuit current rating (SCCR): 200kArms - tested without external CB or fuse



Part No.		Pole	Max. Discharge Current, I <sub>max</sub> (8/20μs) (kA)	Nominal Discharge Current, I <sub>n</sub> (8/20μs) (kA)	Nominal Voltage (VAC)	Max. Continuous Operating Voltage, MCOV (VAC)	Voltage Protection Rating, VPR (kV)	SCCR Rating (kArms)
Type 1CA	Type 2CA							
SPD150-S	SPD150C-S	1	75	20	120	150	0.7	200
SPD180-S	SPD180C-S	1	75	20	127	180	1.0	200
SPD275A-S	SPD275AC-S	1	75	20	230	275	1.0	200
SPD320-S	SPD320C-S	1	75	20	277	320	1.2	200

### Single pole

- Dimension drawing

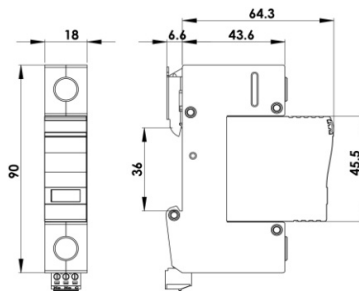

- Basic circuit diagram

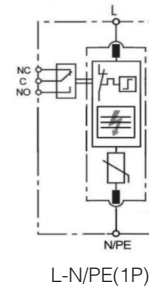





Prosurge SPV series is a Type 1CA DC SPD according to UL1449 5th, designed for Photovoltaic system DC-side and EV DC charge pile protection against the damage from surges caused by lightning and other electrical sources.

**Rating:**

- **Max. permitted DC voltage (Vpvd): 85V~1500Vdc**
- **Max. discharge current (8/20us): 50kA**
- **Short circuit current rating (SCCR): 100kA - tested without external CB or fuse**

**Technical Features:**

- UL recognized Type 1CA PV/DC SPD per ANSI/UL1449 5th and CSA C22.2 for EV (electric vehicle) charger, PV/ Photovoltaic and other DC power system. (UL File No. E319871)
- Pluggable design with window fault indication
- Remote alarm signal optional
- Meet worldwide standards of UL1449 5th, IEC/EN 61643-31 & EN50539-11
- Global patented thermal disconnecter design with arc extinguishing device, fail-safe & self-protected, quick thermal response and perfect circuit cutoff function. No additional over-current protection devices required



**Single mode or I Configuration protection**

Part No.		Pole	Nominal Voltage (Vdc)	Max. Permitted DC Voltage, Vpvd (V)	Nominal Discharge Current, In (8/20µs) (kA)	Max. Discharge Current, Imax (8/20µs) (kA)	Voltage Protection Rating, VPR (kV)	SCCR Rating (kA)
Type 1ca	Type 2ca							
SPV48-V-S	SPV48-V-S/C	1	48	85	20	50	0.4	100
SPV500-V-S	SPV500-V-S/C	1	500	560	20	50	1.5	100
SPV600-V-S	SPV600-V-S/C	1	600	670	20	50	1.5	100

• Dimension drawing

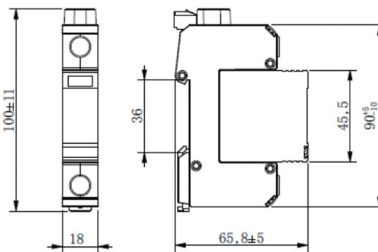

• Basic circuit diagram

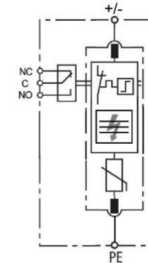

**V Configuration protection**

Part No.		Pole	Nominal Voltage (Vdc)	Max. Permitted DC Voltage, Vpvd (V)	Nominal Discharge Current, In (8/20µs) (kA)	Max. Discharge Current, Imax (8/20µs) (kA)	Voltage Protection Rating, VPR (kV)	SCCR Rating (kA)
Type 1ca	Type 2ca							
SPV48-V-C-S	SPV48-V-C-S/C	2	48	85	20	50	0.4	100
SPV500-V-C-S	SPV500-V-C-S/C	2	500	560	20	50	1.5	100
SPV600-V-C-S	SPV600-V-C-S/C	2	600	670	20	50	1.5	100

• Dimension drawing

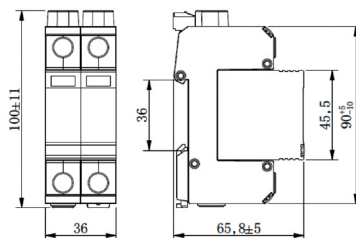

• Basic circuit diagram

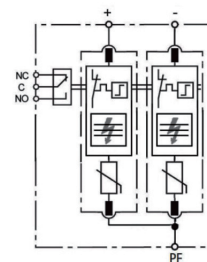



**Y Configuration protection**

Part No.		Pole	Nominal Voltage (Vdc)	Max. Permitted DC Voltage, Vpvc (V)	Nominal Discharge Current, In (8/20µs) (kA)	Max. Discharge Current, Imax (8/20µs) (kA)	Voltage Protection Rating, VPR (kV)	SCCR Rating (kA)
Type 1CA	Type 2CA							
SPV600-V-CD-S	SPV600-V-CD-S/C	3	600	700	20	50	1.8	100
SPV800-V-CD-S	SPV800-V-CD-S/C	3	800	920	20	50	2.5	100
SPV1000-V-CD-S	SPV1000-V-CD-S/C	3	1000	1120	20	50	2.5	100
SPV1200-V-CD-S	SPV1200-V-CD-S/C	3	1200	1340	20	50	3.0	100
SPV1500-V-CD-S	SPV1500-V-CD-S/C	3	1500	1500	20	50	4.0	100

- Dimension drawing

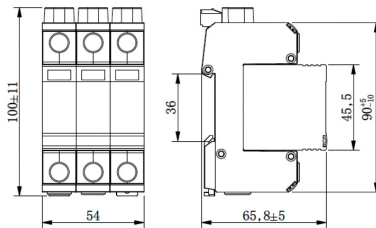

- Basic circuit diagram

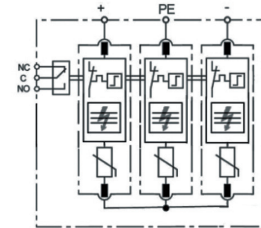

**2Y Configuration protection**

Part No.		Pole	Nominal Voltage (Vdc)	Max. Permitted DC Voltage, Vpvc (V)	Nominal Discharge Current, In (8/20µs) (kA)	Max. Discharge Current, Imax (8/20µs) (kA)	Voltage Protection Rating, VPR (kV)	SCCR Rating (kA)
Type 1CA	Type 2CA							
SPV600-V-CD2-S	SPV600-V-CD2-S/C	3	600	700	20	50	1.8	100
SPV800-V-CD2-S	SPV800-V-CD2-S/C	3	800	920	20	50	2.5	100
SPV1000-V-CD2-S	SPV1000-V-CD2-S/C	3	1000	1120	20	50	2.5	100
SPV1200-V-CD2-S	SPV1200-V-CD2-S/C	3	1200	1340	20	50	3.0	100
SPV1500-V-CD2-S	SPV1500-V-CD2-S/C	3	1500	1500	20	50	4.0	100

- Dimension drawing

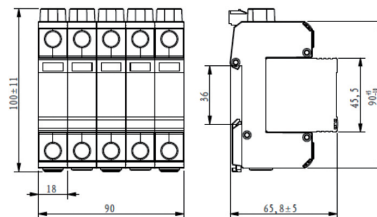

- Basic circuit diagram

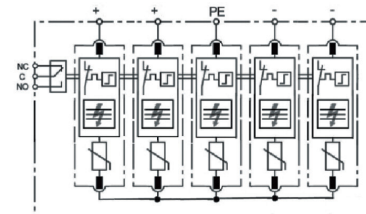



## DC PV surge protection modules

Prosurge's SPM series are surge protection modules which are heavy MOV based devices and are constructed with Prosurge thermal protection and arc extinguishing technology, can be easily integrated in or mounted on PCBs. They are the best choice for global customers to develop PV/DC power electronics to minimize the potential impact of lightning events.

### Rating:

- **Max. permitted DC voltage (Vpvc): 85V~825Vdc**
- **Max. discharge current (8/20us): 50kA**
- **Short circuit current rating (SCCR): 100kA - tested without external CB or fuse**

### Technical Features:

- UL recognized Type 1CA DC SPD per ANSI/UL1449 5th and CSA C22.2 for EV (electric vehicle) charger, PV/ Photovoltaic and other DC power system. (UL File No. E319871)
- Completely meet IEC/EN 61643-11/31 & EN50539-11
- Quick thermal response and perfect circuit cutoff function due to special thermal disconnecter design with arc extinguishing device (Patent pending)
- Wide operating temperature range and high reliability
- High surge current capacity and low leakage current
- Provide a number of ways to use on PCB, such as permanent soldering or pluggable
- Floating remote signaling contact for fault indication while additional uses of PVD\_Base



Part No.		Nominal Voltage (Vdc)	Max. Permitted DC Voltage, Vpvc (V)	Nominal Discharge Current, In (8/20µs) (kA)	Max. Discharge Current, Imax (8/20µs) (kA)	Voltage Protection Rating, VPR (kV)	SCCR Rating (kA)
Type 1CA	Type 2CA						
SP85D	SP85D/C	48	85	20	50	0.4	100
SP350D	SP350D/C	300	350	20	50	0.9	100
SP460D	SP460D/C	400	460	20	50	1.2	100
SP560D	SP560D/C	500	560	20	50	1.5	100
SP670D	SP670D/C	600	670	20	50	1.5	100
SP825D	SP825D/C	750	825	20	50	1.8	100

### Dimension drawing

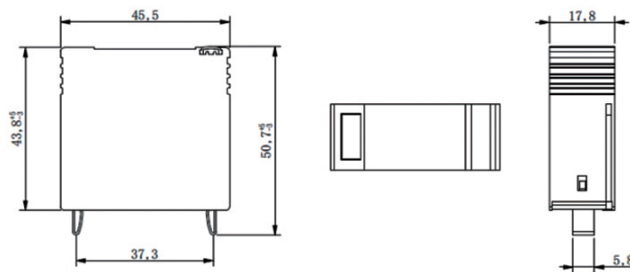

### Basic circuit diagram

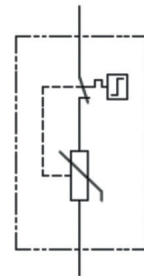

## PCB mounting method and illustration

PVD\_Base is designed for pluggable SPM module to be mounted on the PCB and can be replaced easily, and with floating remote signaling contact for fault indication.

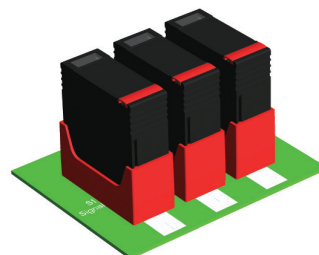
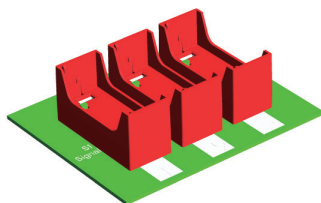



Prosurge MDSS series is designed for low-voltage DC power supply system protection against the damaging from surges and spikes caused by lightning and other electrical sources, suitable for use in category location B,C (ANSI/IEEE C62.41)

### Technical Features

- Type 4CA design according to ANSI/UL1449 5th, Class III design to IEC/EN 61643-11/31
- MCOV (Vdc): 24V~110Vdc
- Large surge capacity up to 20kA 8/20µs
- For common mode & differential mode protection
- Thermally protected MOV technology
- DIN-rail mount configuration and compact design, 18mm width (1 module, DIN 43880)
- Pluggable design with window fault indication
- Remote alarm signal optional



Part No.	Nominal Voltage (Vdc)	Nominal Discharge Current, In (8/20µs) (kA)	Max. Discharge Current, Imax (8/20µs) (kA)	Open Circuit Voltage, Uoc (kV)	Voltage Protection Level, Up (V)
MDSS10/12-2V-S	12	5	10	10	160
MDSS10/24-2V-S	24	5	10	10	180
MDSS20/36-2V-S	36	10	20	20	330
MDSS20/48-2V-S	48	10	20	20	370
MDSS20/60-2V-S	60	10	20	20	460
MDSS20/110-2V-S	110	10	20	20	700

### Common mode protection

- Dimension drawing

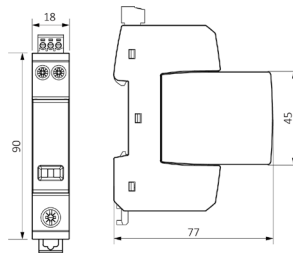

- Basic circuit diagram

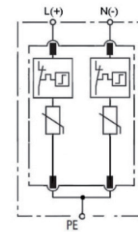



PROSUGE WS05 series Surge Protective Devices are for surge protection of single phase AC power lines. It can effectively suppress the transient over voltage on power line caused by lightning strikes and other electrical source. They are recommended for LED light protection, machine and equipment protection. The products are generally installed in the distribution or power unit of the equipment to be protected.

**Technical Features**

- Surge arrester comply with IEC/EN 61643-11 and UL1449 5th
- Suitable for single phase AC power application
- Patented fail-safe technology to prevent a hazard to the facility due to end-of-life of MOV component or extreme failure conditions which may caused by abnormal line voltage fluctuation etc
- Offering full mode protection
- Max. discharge current up to 15kA 8/20 us and open circuit voltage Uoc to 20kV
- Installed in series (model: WS..S) or parallel(model: WS...P) to power supply
- LED fault indication
- IP67 waterproof enclosure to resist dirt, dust and water



Type	WS05S, WS05P
In Accordance With	IEC/EN 61643-11; UL1449 5th
Category UL/IEC/EN	Type 2CA /III/T3
Connection Type	P-Parallel connection; S-Series connection
Nominal Current IL	5A (for series connection)
Mode Of Protection	Full mode protection
Nominal Discharge Current In	5kA
Max. Discharge Current Imax	15kA
Open Circuit Voltage Uoc	20kV
Short-Circuit Current Rating Isccr	25kArms
Leakage Current	≤0.1mA
Backup Fuse(Only required if not already provided in mains)	25A gL/gG
Failure Indication/Status	LED ON=Normal; LED OFF=Failure or power off
Thermal Disconnecter	internal
Working Envioment	- 40°C ~ +70°C; ≤95% RH
Connection Wire	18AWG(L=Black; N=White; PE=Yellow/Green) ,150mm
Enclosure Material	thermoplastic; extinguishing degree UL94 V-0
Degree Of Protection	IP67 (Waterproof)
Dimension	40x50x33mm
Altitude	≤4000m
Certification	UL, CE

• Dimension drawing

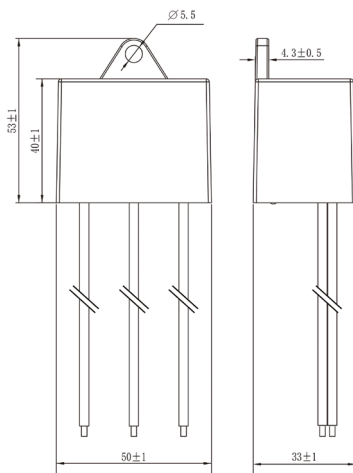

• Examples of installationinstallation

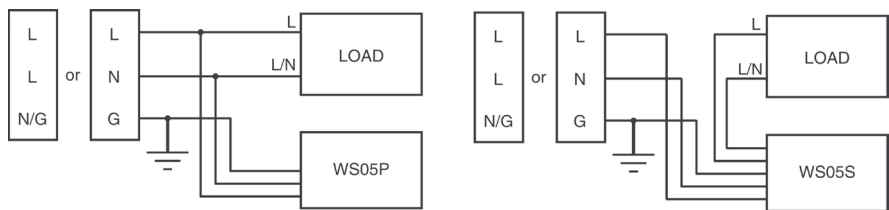





# Surge Protection for LED Lighting

Model No.	System Voltage (50/60Hz)	In (kA)	Protected Mode				Voltage Protection Ratings (VPR @6kV/ 3kA.V)				MCOV (Vac)
			L-N	L-G	N-G	L-L	L-N	L-G	N-G	L-L	
WS05S-120SPN-2P-F	120/240V Split-phase	5	✓	✗	✗	✓	600	-	-	1000	150/300
WS05S-120SPG-2P-F		5	✗	✓	✗	✓	-	600	-	1000	150/300
WS05S-240SPN-2P-F	240/480V Split-phase	5	✓	✗	✗	✓	900	-	-	1800	275/550
WS05S-240SPG-2P-F		5	✗	✓	✗	✓	-	900	-	1800	275/550
WS05S-120S-3P-F	120V Single-phase	5	✓	✓	✓	✗	600	600	600	-	150
WS05S-120S-2P-F		5	✗	✓	✓	✗	-	600	600	-	150
WS05S-120S-P-F		5	✗	✓	✗	✗	600	-	-	-	150
WS05S-240S-3P-F	240V Single-phase	5	✓	✓	✓	✗	900	900	900	-	275
WS05S-240S-2P-F		5	✗	✓	✓	✗	-	900	900	-	275
WS05S-240S-P-F		5	✗	✓	✗	✗	900	-	-	-	275
WS05S-277S-3P-F	277V Single-phase	5	✓	✓	✓	✗	1000	1000	1000	-	320
WS05S-277S-2P-F		5	✗	✓	✓	✗	-	1000	1000	-	320
WS05S-277S-P-F		5	✗	✓	✗	✗	1000	-	-	-	320
WS05S-347S-3P-F	347V Single-phase	5	✓	✓	✓	✗	1500	1500	1500	-	420
WS05S-347S-2P-F		5	✗	✓	✓	✗	-	1500	1500	-	420
WS05S-347S-P-F		5	✗	✓	✗	✗	1500	-	-	-	420
WS05S-480S-3P-F	480V Single-phase	5	✓	✓	✓	✗	1800	1800	1800	-	550
WS05S-480S-2P-F		5	✗	✓	✓	✗	-	1800	1800	-	550
WS05S-480S-P-F		5	✗	✓	✗	✗	1800	-	-	-	550



Prosurge D-05/BNC surge arrester is designed for coaxial systems such as camera and video system protection against the damage from surges and spikes caused by lightning and other electrical sources, suitable for use in category location B, C (ANSI/IEEE C62.41) or directly at the upstream near the protected devices.

**Technical Features**

- Data network protector in according with UL 497b, IEC 61643-21
- High discharge capacity, total nominal discharge current up to 20kA 8/20µs
- Two-stage protection circuit
- Limit the transient with gas discharge tubes and transorb diodes
- Comprising a PTC for overcurrent fault and short-circuit fault protection
- BNC connector for protection of video signal, cameras or TV system
- Low insertion loss



Part No.		D-05/BNC-FF50-B
Nominal Voltage (Vdc)	Un	5V
Max. Continuous Operating Voltage (Vdc/Vac)	Uc	6/5V
C2 Nominal Discharge Current (8/20µs)	In	10kA
C2 Total Nominal Discharge Current (8/20µs)	In	20kA
Voltage Protection Level	L-SG@C2 (8/20µs) Up	≤30V
	L-SG@C3 (1kV/µs) Up	≤24V
Frequency Range	f	0~20MHz
Nominal Current	IL	0.35A
Technology		Two-stage protection circuit, GDT/SAD & PTC technology
Insertion Loss At 20MHz		< 0.2dB
VSWR		< 1.2dB
Continuous Power	P	0.77 Watts
Series Impedance Per Line	R	0.6 Ohm (PTC)
Input / Output Connection Type		BNC, 50 Ohm

• Dimension drawing

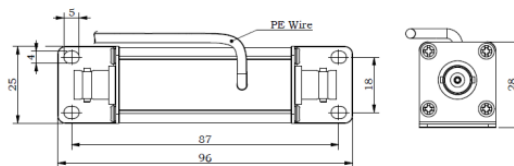

• Basic circuit diagram

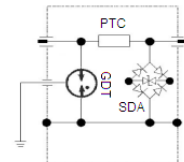

**Multiport Coaxial Protector**

- 8-ports protector DSB05/BNC-8P
- 16-ports protector DSB05/BNC-16P 19" bay design
- 24-ports protector DSB05/BNC-24P 19" bay design



Part No.		DSB05/BNC-8P	DSB05/BNC-16P	DSB05/BNC-24P
Number of Connection Ports		8	16	24
Nominal Voltage (Vdc)	Un	5V		
Max. Continuous Operating Voltage (Vdc)	Uc	8V		
Open Circuit Voltage (1.2/50µs)	Uoc	5kV (L-SG), 10kV (SG-PG)		
Lightning Impulse Current (10/350µs)	Iimp	0.5kA		
Nominal Discharge Current (8/20µs)	In	2.5kA (L-SG), 5kA (SG-PG)		
Max. Discharge Current (8/20µs)	I <sub>max</sub>	5kA (L-SG), 10kA(SG-PG)		
Voltage Protection Level at In	Up	≤25V (L-SG)		
Voltage Protection Level at 1kV/µs	Up	≤15V (L-SG), ≤600V (L/SG-PG)		
Bandwidth	fG	300MHz		

• Dimension drawing

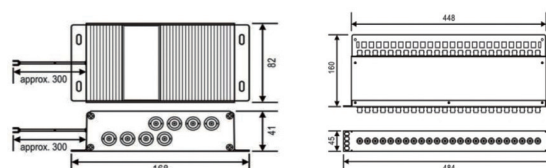

• Basic circuit diagram

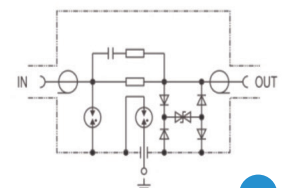



Prosurge D-05/RJ45-CAT6/H Protector is designed for Gigabit Ethernet terminals against surges. It is suitable for use in category location B, C (ANSI/IEEE C62.41) or directly at the upstream near the protected devices.

## Technical Features

- Data network protector in according with standard UL 497b, EN 50173 Category 6, IEC 61643-21
- Ethernet CAT6 & CAT5 system protection
- Applied in offices and industries like Gigabit Ethernet, ATM or ISDN system, and VoIP system (e.g. switch, router, hub, modem and so on)
- High discharge capacity, total nominal discharge current 10kA 8/20 $\mu$ s and Lightning current up to 1.0kA 10/350 $\mu$ s
- RJ45 connector for CAT6 & CAT 5 network technology, 100BaseT, 1000BaseT, 8 wires protection
- DIN-rail type is available



Part No.		D-05/RJ45-CAT6/H
Nominal Voltage (Vdc)	Un	5V
Max. Continuous Operating Voltage (Vdc)	Uc	6V
C2 Nominal Discharge Current (8/20 $\mu$ s)	In	2.5kA
C2 Total Nominal Discharge Current (8/20 $\mu$ s)		10kA
Voltage Protection Level	L-SG@C2 (8/20 $\mu$ s) Up	$\leq 55V$
	L-SG@C3 (1KV/ $\mu$ s) Up	$\leq 25V$
Lightning Impulse Current (10/350 $\mu$ s)	Iimp	1.0kA
Nominal Current	IL	200mA
Transmission Speed		1000Mbps
Insertion Loss At 250MHz		$\leq 3.0dB$
Transmission Standards		100BaseT / 1000BaseT / 1000BaseTX (CAT6)

### • Dimension drawing

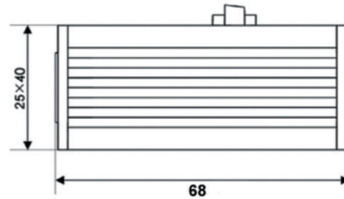

### • Basic circuit diagram

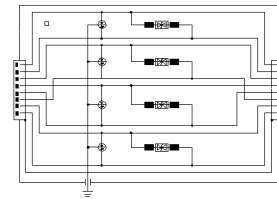

## Multipoint 1Gb Protector

24-ports protector DSB05/RJ45-CAT6-H-24P 19"bay design



Part No.		DSB05/RJ45-CAT6-H-24P
Number Of Connection Ports		24
Nominal Voltage (Vdc)	Un	5V
Max. Continuous Operating Voltage (Vdc)	Uc	6V
C2 Nominal Discharge Current (8/20 $\mu$ s)	In	2.5kA
C2 Total Nominal Discharge Current (8/20 $\mu$ s)		10kA
Voltage Protection Level	@C2 (8/20 $\mu$ s) Up	$\leq 55 (L-L); \leq 400V (L-G)$
	@C3 (1KV/ $\mu$ s) Up	$\leq 25V (L-L); \leq 500V (L-G)$
Lightning Impulse Current (10/350 $\mu$ s)	Iimp	1kA
Nominal Current	IL	1A
Insertion Loss		$\leq 0.1dB$
Transmission Speed		1000Mbps
Technology		Two-stage protection circuit, GDT/SAD technology
Transmission Standards		10BaseT/100BaseT/1000BaseT/1000BaseTX(CAT6)

### • Dimension drawing

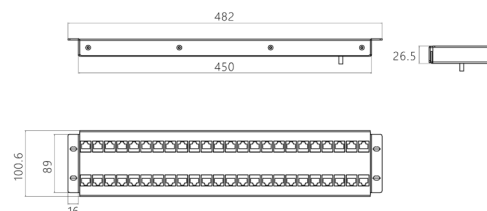

### • Basic circuit diagram

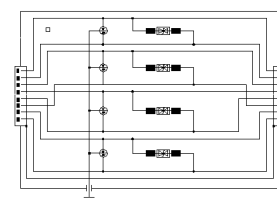



Prosurge D-48 CAT6-PoE Protector is designed for protecting Gigabit Ethernet & Power-over Ethernet (PoE) terminals such as Internet camera, IP Telephone sets, and wireless access point, and are suitable for use in category location B, C (ANSI/IEEE C62.41) or directly at the upstream near the protected devices.

**Technical Features**

- Data network protector in according with standard IEEE802.3 at/af, UL 497b, EN 50173 Category 6, IEC 61643-21
- PoE,PoE+compatible, Ethernet CAT6 & CAT5 system protection
- High discharge capacity, total nominal discharge current 10kA 8/20µs and Lightning current up to 1.0kA 10/350µs
- In aluminum housing
- RJ45 connector for CAT6 & CAT5 network technology, 100BaseT, 1000BaseT, 8 wires protection



Part No.		D-48/RJ45-CAT6/H(POE)-B
Nominal Voltage (Vdc)	Un	48V
Max. Continuous Operating Voltage (Vdc)	Uc	68V
C2 Nominal Discharge Current (8/20µs)	In	2.5kA
C2 Total Nominal Discharge Current (8/20µs)		10kA
Voltage Protection Level	@C2 (8/20µs) Up	≤ 190V (L-L); ≤ 500V (L-G)
	@C3 (1KV/µs) Up	≤ 145V (L-L); ≤ 600V (L-G)
Lightning Impulse Current (10/350µs)	Iimp	1kA
Nominal Current	IL	800mA
Insertion Loss		≤ 0.1dB
Transmission Speed		1000Mbps
Technology		Two-stage protection circuit, GDT/SAD technology
Transmission Standards		10BaseT / 100BaseT / 1000BaseT / 1000BaseTX (CAT6) / PoE
Pinning		1/2, 3/6, 4/5, 7/8 for data; 1&2 / 3&6, 4&5 / 7&8 for PoE,PoE+

• Dimension drawing

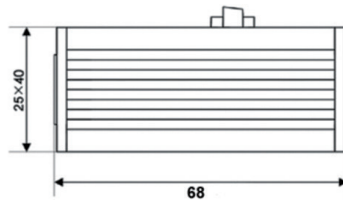

• Basic circuit diagram

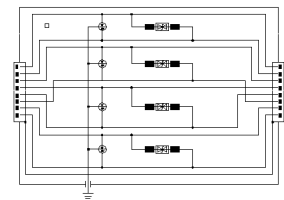

**Multiport 1Gb-PoE Protector**

24-ports protector DSB48/RJ45-CAT6-H(POE)-24P 19" bay design



Part No.		DSB48/RJ45-CAT6-H(POE)-24P
Number Of Connection Ports		24
Nominal Voltage (Vdc)	Un	48V
Max. Continuous Operating Voltage (Vdc)	Uc	57V
C2 Nominal Discharge Current (8/20µs)	In	2.5kA
C2 Total Nominal Discharge Current (8/20µs)		10kA
Voltage Protection Level	@C2 (8/20µs) Up	≤ 150 (L-L); ≤ 400V (L-G)
	@C3 (1KV/µs) Up	≤ 110 (L-L); ≤ 500V (L-G)
Lightning Impulse Current (10/350µs)	Iimp	1kA
Nominal Current	IL	1A
Insertion Loss		≤ 0.1dB
Transmission Speed		1000Mbps
Technology		Two-stage protection circuit, GDT/SAD technology
Transmission Standards		10BaseT/100BaseT/1000BaseT/1000BaseTX(CAT6)/ POE,POE+

• Dimension drawing

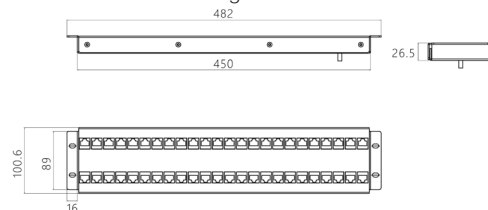

• Basic circuit diagram

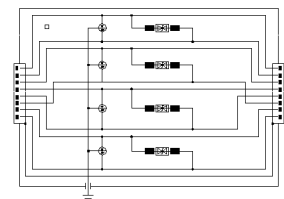



PROSURGE DM.. data network surge arrester are designed for universal 1 or 2-pairs data lines against the damaging from surges and spikes caused by lightning and other electrical sources, suitable for use in category location B, C (ANSI/IEEE C62.41) or directly at the upstream near the protected devices.

### Technical Features

- Data network protector in according with UL497b, IEC/EN61643-21
- 12mm pluggable surge protector for DIN-Rail mounting
- Signal transmission is not interrupted when exchanging module
- Two-stage protection circuit. Limit the transients with gas discharge tubes and transorb diodes
- Earthing is possible on DIN rail
- Different model are suitable to use for universal 4-20mA current loop, TTL, analog telephone line, measurement system and high-frequency bus and data transmission systems etc

- Dimension drawing

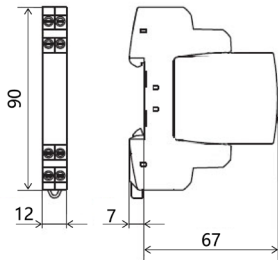

Model		DM-05-M2N1	DM-12-M2N1	DM-24-M2N1	DM-48-M2N1	DM-110-M2N1
		DM-05-M4N1	DM-12-M4N1	DM-24-M4N1	DM-48-M4N1	
Lines Protected		1-Pair / 2-Pair				1-Pair
Nominal Voltage (Vdc)	Un	5V	12V	24V	48V	110V
Max. Continuous Operating Voltage (Vdc/Vac)	Uc	6V/4.2V	15V/10.6V	33V/23.3V	54V/38.1V	170V/120V
C2 Nominal Discharge Current (8/20µs)	In	10kA				
Lightning Impulse Current (10/350µs)	Iimp	2.5kA				
Voltage Protection Level	@C2 (8/20µs) Up	30V(L-L); 30V(L-G)	45V(L-L); 45V(L-G)	55V(L-L); 55V(L-G)	100V(L-L); 100V(L-G)	300V(L-L); 300V(L-G)
	@C3 (1KV/µs) Up	24V(L-L); 24V(L-G)	38V(L-L); 38V(L-G)	48V(L-L); 48V(L-G)	75V(L-L); 75V(L-G)	250V(L-L); 250V(L-G)
Rated Load Current	IL	1A				
Cut-off Frequency	fG	100 MHz				
Series Impedance Per Line	R	0.68 Ω				

- Basic circuit diagram

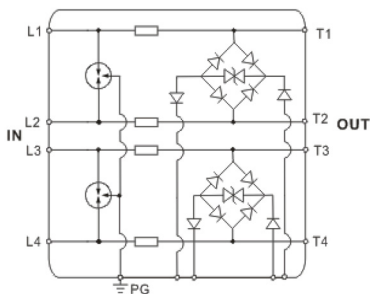

For 2-pair data line  
DM-...-M4N1

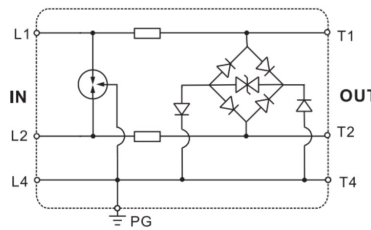

For 1-pair data line  
DM-...-M2N1

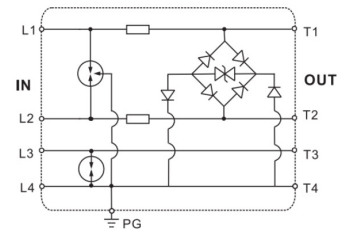

For 1-pair+shield data line  
DM-...-M2N3





Model		DM-05-M2N2	DM-12-M2N2	DM-24-M2N2	DM-48-M2N2	DM-110-M2N2
		DM-05-M4N2	DM-12-M4N2	DM-24-M4N2	DM-48-M4N2	
Lines Protected		1-Pair / 2-Pair				1-Pair
Nominal Voltage (Vdc)	Un	5V	12V	24V	48V	110V
Max. Continuous Operating Voltage (Vdc/Vac)	Uc	6V/4.2V	15V/10.6V	33V/23.3V	54V/38.1V	170V/120V
C2 Nominal Discharge Current (8/20µs)	In	10kA				
C2 Total Nominal Discharge Current (8/20µs)		20kA				
Lightning Impulse Current (10/350µs)	Iimp	2.5kA				
Voltage Protection Level	@C2 (8/20µs) Up	30V(L-L); 500V(L-G)	45V(L-L); 500V(L-G)	55V(L-L); 500V(L-G)	100V(L-L); 500V(L-G)	300V(L-L); 500V(L-G)
	@C3 (1kV/µs) Up	24V(L-L); 600V(L-G)	38V(L-L); 600V(L-G)	48V(L-L); 600V(L-G)	75V(L-L); 600V(L-G)	250V(L-L); 600V(L-G)
Rated Load Current	IL	1A				
Cut-off Frequency	fG	100 MHz				
Series Impedance Per Line	R	0.68 Ω				

• Basic circuit diagram

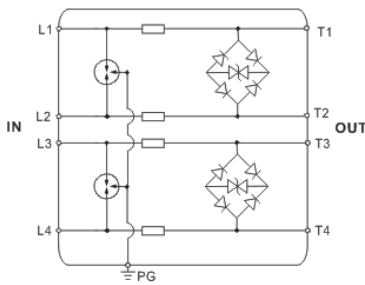

For 2-pair data line  
DM-...-M4N2

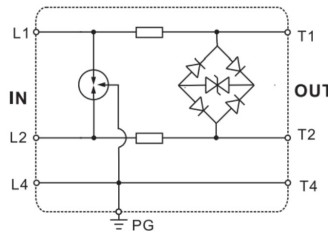

For 1-pair data line  
DM-...-M2N2

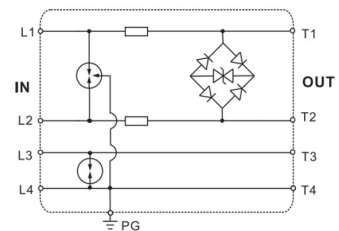

For 1-pair+shield data line  
DM-...-M2N4

Model		DM-05-M2N6	DM-12-M2N6	DM-24-M2N6	DM-48-M2N6
		DM-05-M4N6	DM-12-M4N6	DM-24-M4N6	DM-48-M4N6
Lines Protected		1-Pair / 2-Pair			
Nominal Voltage (Vdc)	Un	5V	12V	24V	48V
Max. Continuous Operating Voltage (Vdc/Vac)	Uc	6V/4.2V	15V/10.6V	33V/23.3V	54V/38.1V
C2 Nominal Discharge Current (8/20µs)	In	10kA			
C2 Total Nominal Discharge Current (8/20µs)		20kA			
Lightning Impulse Current (10/350µs)	Iimp	2.5kA			
Voltage Protection Level	@C2 (8/20µs) Up	30V(L-L); 500V(L-G)	45V(L-L); 500V(L-G)	55V(L-L); 500V(L-G)	100V(L-L); 500V(L-G)
	@C3 (1kV/µs) Up	24V(L-L); 600V(L-G)	38V(L-L); 600V(L-G)	48V(L-L); 600V(L-G)	75V(L-L); 600V(L-G)
Rated Load Current	IL	2A			
Cut-off Frequency	fG	100 MHz			
Series Impedance Per Line	R	0 Ω			

• Basic circuit diagram

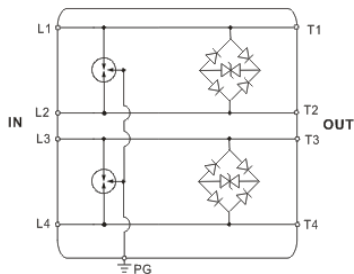

For 2-pair data line  
DM-...-M4N6

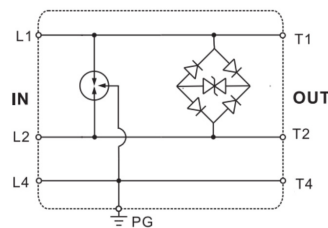

For 1-pair data line  
DM-...-M2N6



Model		DM-12-M2N5	DM-24-M2N5	DM-48-M2N5	DM-110-M2N5
Lines Protected		1-Pair			
Nominal Voltage (Vdc)	Un	12V	24V	48V	110V
Max. Continuous Operating Voltage (Vdc/Vac)	Uc	15V/10.6V	33V/23.3V	54V/38.1V	170V/120V
C2 Nominal Discharge Current (8/20µs)	In	10kA			
C2 Total Nominal Discharge Current (8/20µs)		20kA			
Lightning Impulse Current (10/350µs)	Iimp	2.5kA			
Voltage Protection Level	@C2 (8/20µs) Up	25V(L-L); 750V(L-G)	50V(L-L); 750V(L-G)	100V(L-L); 750V(L-G)	260V(L-L); 750V(L-G)
	@C3 (1kV/µs) Up	19V(L-L); 650V(L-G)	45V(L-L); 650V(L-G)	70V(L-L); 650V(L-G)	230V(L-L); 650V(L-G)
Rated Load Current	IL	1A			
Cut-off Frequency	fG	2 MHz			
Series Impedance per Line	R	1.36 Ω			

• Basic circuit diagram

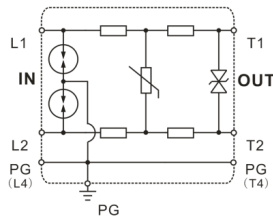

For 1-pair data line  
DM-...-M2N5

DM-...-M..N7 data network protector is with **failure indication and fault-current** protection inside to make protection module replacement timely and prevent failure or even destruction of signal or communication system. These modules are suitable for digital I/O signal or analog power surge protection.



Model		DM-05-M2N7	DM-12-M2N7	DM-24-M2N7	DM-48-M2N7
		DM-05-M4N7	DM-12-M4N7	DM-24-M4N7	DM-48-M4N7
Lines Protected		1-Pair / 2-Pair			
Nominal Voltage (Vdc)	Un	5V	12V	24V	48V
Max. Continuous Operating Voltage (Vdc/Vac)	Uc	6V/4.2V	15V/10.6V	33V/23.3V	54V/38.1V
C2 Nominal Discharge Current (8/20µs)	In	L-L:300A, L-G:10kA			
C2 Total Nominal Discharge Current (8/20µs)		L-L:500A, L-G:20kA			
Lightning Impulse Current (10/350µs)	Iimp	2.5kA			
Voltage Protection Level	@C2 (8/20µs) Up	30V(L-L); 500V(L-G)	45V(L-L); 500V(L-G)	55V(L-L); 500V(L-G)	100V(L-L); 500V(L-G)
	@C3 (1kV/µs) Up	24V(L-L); 600V(L-G)	38V(L-L); 600V(L-G)	48V(L-L); 600V(L-G)	75V(L-L); 600V(L-G)
Rated Load Current	IL	1A			
Cut-off Frequency	fG	2 MHz			
Series Impedance per Line	R	PTC			

• Dimension drawing

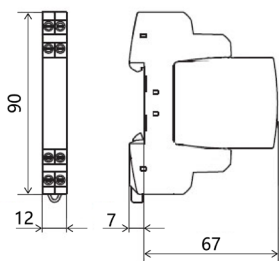

• Basic circuit diagram

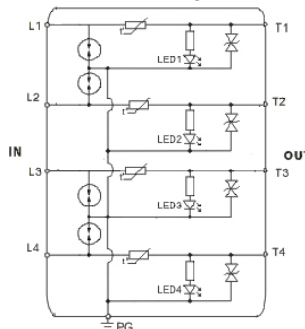

For 2-pair data line  
DM-...-M4N7

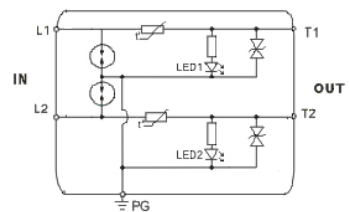

For 1-pair data line  
DM-...-M2N7



The PROSURGE Intelligent Surge & Power Monitor is a multi-function monitoring device for power system and LPS (lightning Protecting System), a core unit for Intelligent LPS or Surge Protective Devices (iSPDs), which is an innovative solution to make your LPS smart and intelligent. It can be widely used in Telecom, Railway electrical system, Wind power plant, Photovoltaic power plant, Network communication system, Building electrical system and Automatic industrial lightning protection etc.. It has a leading technology and stable functions. Through local Man-Machine interface or connecting to remote monitoring center, users can check completed LPS information.



**LEC-AT**

- ✓ Monitor and record 999's lightning and surge event (polarity, event time, total events quantity)
  - ✓ Buzzer alarm when the number of lightning and surge event reaches a settable value
- OLED display, support history events information query  
RS-485 communication interface, users can browse history events information on the far-end PC

• Dimension drawing

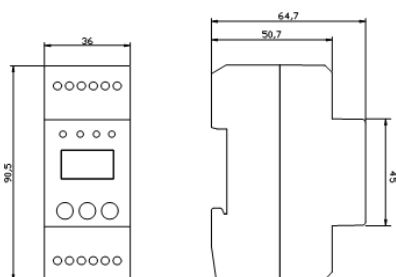

• Examples of installation

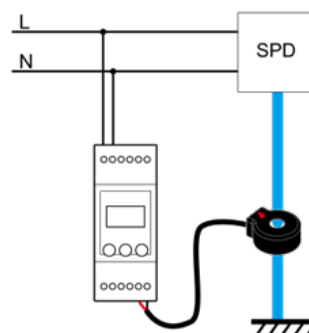

**iSPM-02**

- ✓ Monitor and record 999's lightning and surge event (polarity, event time, total events quantity)
  - ✓ SPD working status with alarm
  - ✓ SPD's aging with alarm when close to end-of-life
  - ✓ Backup over-current protection device working status (circuit breaker or fuse) with alarm
  - ✓ Voltage on SPD in real-time, overvoltage alarm
  - ✓ Grounding conditions of SPD with alarm
  - ✓ N line monitor ( screen light off while lost, alarm by remote signal contact)
- OLED display, support history events information query  
RS-485 communication interface, users can browse history events information on the far-end PC

• Dimension drawing

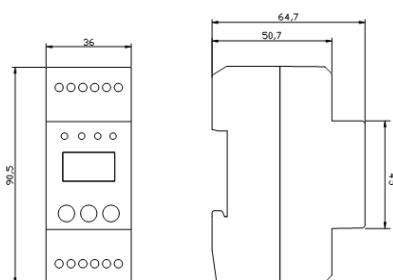

• Examples of installation

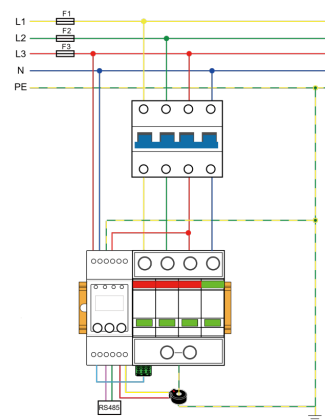



**iSPM-03**

- ✓ Monitor and record 5000's lightning and surge event (surge amplitude, polarity, event time, total events quantity)
- ✓ SPD working status with alarm
- ✓ SPD's leakage current measurement
- ✓ SPD's aging with alarm when close to end-of-life
- ✓ Power line & Grounding monitor with alarm while lost
- ✓ Backup over-current protection device working status (circuit breaker or fuse) with alarm
- ✓ Voltage on SPD in real-time (all phase lines), overvoltage alarm

TFT display, support history events information query

RS-485 communication interface, users can browse history events information on the far-end PC

Din rail design, easy to install and use

- Dimension drawing

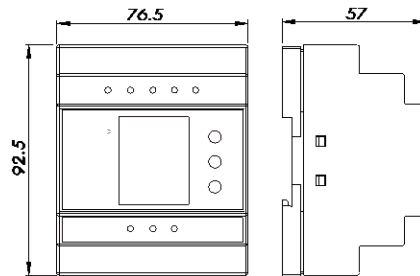

- Examples of installation

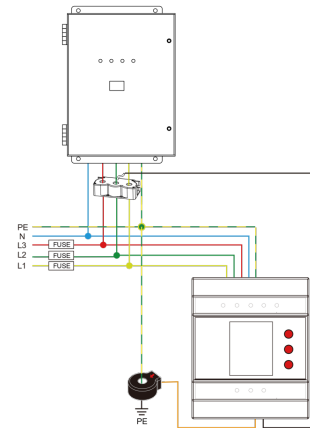

**iSPM-04**

- ✓ Monitor and record 5000's lightning and surge event (polarity, event time, total events quantity)
- ✓ SPD working status with alarm
- ✓ Backup over-current protection device working status (circuit breaker or fuse) with alarm
- ✓ Voltage on SPD in real-time, overvoltage alarm
- ✓ Grounding conditions of SPD with alarm
- ✓ N line monitor ( screen light off while lost, alarm by remote signal contact)
- ✓ Buzzer alarm when the number of lightning and surge event reaches a settable value

TFT display, support history events information query

RS-485 communication interface, users can browse history events information on the far-end PC

Web-based device, can be accessible via standard Web-browsers

E-mail pushing,users never miss fault information anywhere and anytime

Din rail design, easy to install and use

- Dimension drawing

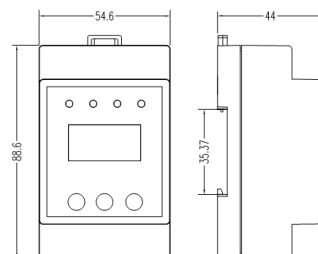

- Examples of installation

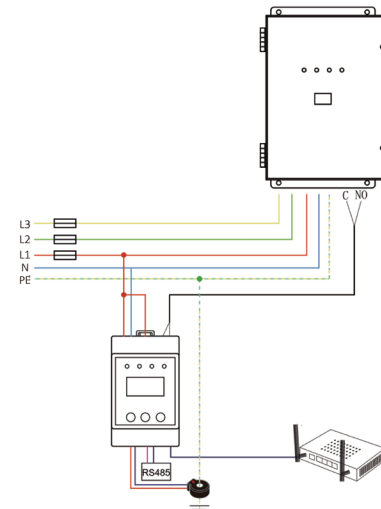



**LSM-CT01**

✓ **Monitor and record 500's lightning and surge event (surge amplitude, polarity, event time, total events quantity)**

✓ **SPD working status**

USB interface for data export

TFT display, support history events information query

RS-485 communication interface, users can browse history events information on the far-end PC

• Dimension drawing

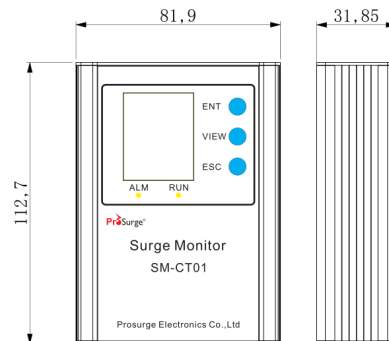

• Examples of installation

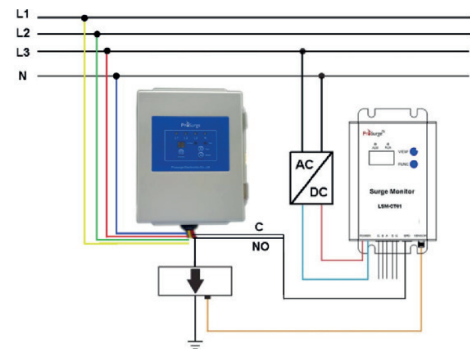



PROSURGE SCB provides enhance backup over-current protection for the SPD, which is located externally upstream of SPD, to avoid overheating and destruction of the SPD. Comparing to normal backup device, like as traditional circuit breaker/fuse, the PROSURGE SCB is fully coordinated with the surge protective device, which achieves a better balance between surge withstand performance (no tripping while expected surge occurs) and sharp reaction against short circuit and abnormal leakage current.

When the Prosurge SCB is used in SPD circuit, the short current will be limited to less than 3A in case the SPD is unable to interrupt the power frequency short circuit current, which usually cause by power frequency temporary overvoltage(TOV). And because of this, the limited short circuit current will not lead to overheating of SPD and even burning, that makes SPDs safe and more reliable in most applications.

The SCB is also featuring the lower residual voltage while surge happens and compact size.

• **Used with class I/T1 SPD**

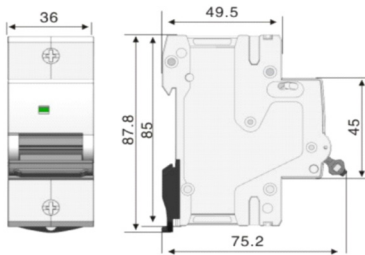

Part No.	SCB B15-1P	SCB B25-1P	SCB B50-1P
Pole Number	1P		
Nominal Voltage Un	230/400Vac		
Operating Frequency	50/60Hz		
Rated Max. Impulse Current (10/350us) Iimp	15kA	25kA	50kA
Nominal Discharge Current (8/20us) In	50kA	60kA	80kA
Rated Short Circuit Current Capacity Icn	100kArms	100kArms	100kArms
Rated Trip Current (Frequency Current)	3A		
Rated Trip Time	<0.1s		
IP Protection Level	IP20		
Wire Connection	Flexible:2.5~25mm <sup>2</sup> Stranded:2.5~35mm <sup>2</sup>		
Operating Temperature	~25°C~60°C		
Installation Width	36mm		

• **Used with class II/T2 SPD**

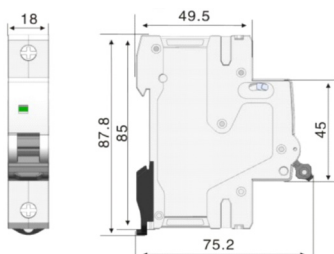

Part No.	SCB C40-1P	SCB C65-1P	SCB C80-1P
Pole Number	1P		
Nominal Voltage Un	230/400Vac		
Operating Frequency	50/60Hz		
Rated Max. Discharge Current (8/20us) I <sub>max</sub>	40kA	65kA	80kA
Nominal Discharge Current (8/20us) In	20kA	35kA	40kA
Rated Short Circuit Current Capacity Icn	35kArms	50kArms	50kArms
Rated Trip Current (Frequency Current)	3A		
Rated Trip Time	<0.1s		
IP Protection Level	IP20		
Wire Connection	Flexible:2.5~25mm <sup>2</sup> Stranded:2.5~35mm <sup>2</sup>		
Operating Temperature	~25°C~60°C		
Installation Width	18mm		





The **PROSURGE iSPD** is an intelligent and auto self-protected SPD for the single phase or multi phase power systems. It's an innovative solution for most commercial and industrial environments with critical operations, to make your surge protection smart and intelligent.

The iSPD is composed of three essential parts: surge protective device (SPD), intelligent surge & power monitor (iSPM) or Lightning/Surge event counter LEC-AT and surge circuit breaker (SCB).

PROSURGE high performance **SPDs** (Type 1ca per UL1449 5th) of iSPD can protect sensitive equipment from the harmful transient voltage surges resulting from:

- Direct and indirect lightning strikes
- Power company load switching
- Upstream load switching at other facilities



Prosurge's Type 1ca SPD

PROSURGE **iSPM / LEC-AT** technology makes it easy to monitor the power & lightning protecting system. This device allows end user to monitor real time power quality for SPD and Lightning/Surge event and get alarm feedback on failure and fault from power system and device self:

- SPD working status with alarm for SPD Failure, -Model: **iSPM02**
- SPD's aging with alarm while close to end-of-life of SPD, -Model: **iSPM02**
- Lightning and surge event (surge polarity, time-to-event, total events quantity) , - Model: **iSPM02/LEC-AT**
- Buzzer alarm when the number of surge events reaches a settable number, - Model: **LEC-AT**
- Backup over-current protection device working status (circuit breaker or fuse) with alarm for CB or fuse open, - Model: **iSPM02**
- Voltage on SPD in real-time, alarm for overvoltage event, - Model: **iSPM02**
- Grounding conditions of SPD with alarm for Grounding fault, - Model: **iSPM02**
- N line lost alarm (screen light off when lost, alarm by remote signal contact), - Model: **iSPM02**



Prosurge's intelligent surge & power monitor



Prosurge 's SCB

PROSURGE **SCB** provides backup over-current protection for the SPD, which is fully coordinated with the SPD's surge capacity. Comparing to normal backup circuit breaker/fuse, the integrated PROSURGE SCB achieves a better balance between surge withstand performance (no tripping while expected surge occurs) and sharp reaction against short circuit and abnormal leakage current.

**The iSPD can communicate with computer or smart terminal.**

It can connect RS485 half-duplex MODBUS RTU protocol communication mode to the remote monitoring center.

Or through the "RS485/Ethernet converter", the MODBUS communication protocol can be converted to the Ethernet protocol, allowing the iSPD to connect to the Internet.

Once the iSPDs are connected to network, end user will be easy to get accurate and convenient information through computer software or smartphone Apps, and be able to act quickly to guarantees system uninterrupted operation based on optimal information.

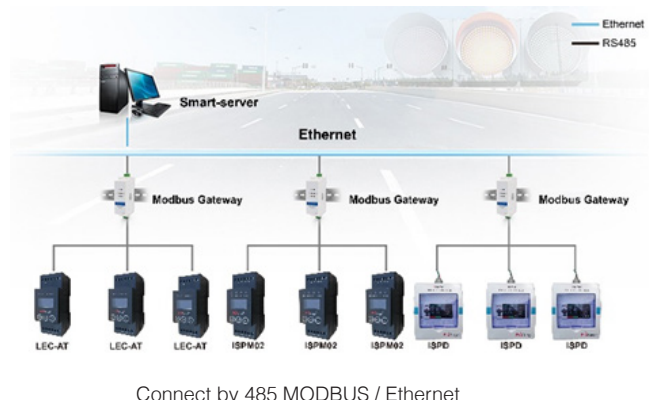
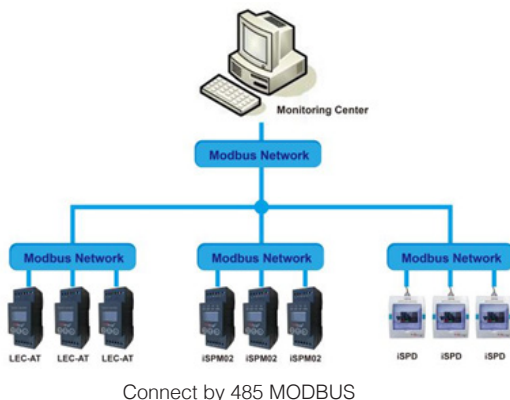



## Configuration & Ordering Information:

<b>iSPD</b> Intelligent SPD Model series	<b>-02</b> Intelligent Surge & Power Monitor Model Series	<b>/C</b> SPD category per IEC/EN	<b>320</b> Max. operating voltage (U <sub>c</sub> )	<b>-PN</b> SPD config	<b>-SCB</b> Back up Surge Circuit Breaker
iSPD	<u>-02</u> : iSPM02 <u>-AT</u> : LEC-AT ...	<u>B</u> : Class I or T1 <u>C</u> : Class II or T2	<u>320</u> : 75VAC~320VAC	<u>2</u> : Two poles (2+0) <u>PN</u> : Two poles (1+1) <u>3</u> : Three poles (3+0) <u>4</u> : Four poles (4+0) <u>3PN</u> : Four poles (3+1)	With or without

## Intelligent Surge & Power Monitor choice:

<b>Function</b>	<b>-02</b>	<b>-AT</b>
Lightning and surge event logging (surge polarity, time-to-event, total events quantity)	✓	✓
Pre-set alarm number of surge event		✓
SPD working status with alarm	✓	
SPD's aging with alarm	✓	
Backup over-current protection device working status with alarm	✓	
Voltage on SPD in real-time with alarm	✓	
Neutral line monitor with alarm	✓	



### iSPD-02/...-SCB

- SPD + iSPM02 + SCB
- Surge capacity 8/20µs: 50kA

Part No.		iSPD-02/C320-PN-SCB	iSPD-02/C320-3PN-SCB	
General	Power System		2W+G, 1ph	
	System Voltage	U <sub>n</sub>	220/380V ~ 240/415V	
	Connection		Connection in parallel	
	Connecting Cable		Power line:10-35mm <sup>2</sup> ; Remote signal:1.5mm <sup>2</sup>	
	Mounting		Wall mounting	
	Dimension		148x180x87 mm	200x180x87 mm
SPD	SPD Category		Type 1ca per UL1449 5th	
	Max. Continuous Operating Voltage AC	U <sub>c</sub>	320VAC	
	Nominal Discharge Current (8/20 µs)	I <sub>n</sub>	20kA	20kA
	Max. Discharge Current (8/20 µs)	I <sub>max</sub>	50kA	50kA
	Voltage Protection Level	U <sub>p</sub>	1.5kV	1.5kV
	Thermal Disconnecter / Indication		Internal red - failure	
iSPM	Display Screen		OLED screen	
	Event Logging		999 events	
	Surge Event Counting		Counting Current ≥100A (adjustable)	
	Communication Interface		RS485	
	Indication		Buzzer / Indicator / Remote signal	
SCB	Trip Current	I <sub>t</sub>	3±1A	
	Trip Time	T <sub>t</sub>	≤40ms	



**iSPD-AT/... SCB**

- SPD + LEC-AT + SCB
- Surge capacity 8/20µs: 50kA

Part No.		iSPD-AT/C320-PN-SCB	iSPD-AT/C320-3PN-SCB
General	Power System		2W+G, 1ph      WYE 4W+G, 3ph
	System Voltage	$U_n$	220/380V ~ 240/415V
	Connection		Connection in parallel
	Connecting Cable		Power line: 10-35mm <sup>2</sup> ; Remote signal: 1.5mm <sup>2</sup>
	Mounting		Wall mounting
	Dimension		148x180x87 mm      200x180x87 mm
SPD	SPD Category		Type 1ca per UL1449 5th
	Max. Continuous Operating Voltage AC	$U_c$	320VAC
	Nominal Discharge Current (8/20 µs)	$I_n$	20kA      20kA
	Max. Discharge Current (8/20 µs)	$I_{max}$	50kA      50kA
	Voltage Protection Level	$U_p$	1.5kV      1.5kV
	Thermal Disconnecter / Indication		Internal red - failure
LEC-AT	Display Screen		OLED screen
	Event Logging		999 events
	Surge Event Counting		Counting Current ≥100A (adjustable)
	Communication Interface		RS485
SCB	Indication		Buzzer / Indicator
	Trip Current	$I_t$	3±1A
	Trip Time	$T_t$	≤40ms



**iSPD-AT/...**

- SPD + LEC-AT
- Surge capacity 8/20µs: 50kA

Part No.		iSPD-AT/C320-PN	iSPD-AT/C320-3PN
General	Power System		2W+G, 1ph      WYE 4W+G, 3ph
	System Voltage	$U_n$	220/380V ~ 240/415V
	Connection		Connection in parallel
	Connecting Cable		Power line: 10-35mm <sup>2</sup> ; Remote signal: 1.5mm <sup>2</sup>
	Mounting		DIN-Rail
	SPD	SPD Category	
SPD	Max. Continuous Operating Voltage AC	$U_c$	320VAC
	Nominal Discharge Current (8/20 µs)	$I_n$	20kA      20kA
	Max. Discharge Current (8/20 µs)	$I_{max}$	50kA      50kA
	Voltage Protection Level	$U_p$	1.5kV      1.5kV
	Thermal Disconnecter / Indication		Internal red - failure
	LEC-AT	Display Screen	
Event Logging			999 events
Surge Event Counting			Counting Current ≥100A (adjustable)
Communication Interface			RS485
Indication			Buzzer / Indicator



**iSPD-...-SCB**

- SPD + SCB
- Surge capacity 8/20µs: 50kA

Part No.		iSPD-C320-PN-SCB	iSPD-C320-3PN-SCB
General	Power System		2W+G, 1ph      WYE 4W+G, 3ph
	System Voltage	$U_n$	220/380V ~ 240/415V
	Connection		Connection in parallel
	Connecting Cable		Power line: 10-35mm <sup>2</sup> ; Remote signal: 1.5mm <sup>2</sup>
	Mounting		DIN-Rail
	SPD	SPD Category	
SPD	Max. Continuous Operating Voltage AC	$U_c$	320VAC
	Nominal Discharge Current (8/20 µs)	$I_n$	20kA      20kA
	Max. Discharge Current (8/20 µs)	$I_{max}$	50kA      50kA
	Voltage Protection Level	$U_p$	1.5kV      1.5kV
	Thermal Disconnecter / Indication		Internal red - failure
	SCB	Trip Current	$I_t$
Trip Time		$T_t$	≤40ms

Lined area for taking notes, consisting of multiple horizontal lines.



Handwriting practice lines on a page titled 'Notes'. The page features a red horizontal line at the top, followed by 20 evenly spaced, thin grey horizontal lines for writing.





We reserve the right to introduce changes in configuration and technology, dimensions, weights and materials in the course of technical progress. Illustrations are not binding. Misprints and errors cannot be ruled out and the right to make changes is reserved.

Any reproduction of this catalogue, as a whole or in parts, is only allowed upon approval of Prosurge Electronics Co., Ltd.

This catalogue is intended as an overview of PROSURGE surge protection devices. More detailed product information can be found at [www.prosurge.com](http://www.prosurge.com) or contact us.



---

## Prosurge Electronics Co., Ltd.

 +86 757 8632 7660

 [info@Prosurge.com](mailto:info@Prosurge.com)

 Building 27th, Phase 2, Liando U Valley, Danzao, Foshan, Guangdong, 528216 China

---

▶ Prosurge's products are distributed in more than 60 countries worldwide via our distributors.