

E800 Manual

Contents

SCANNER SETUP GUIDE	- 1 -
Product Description	- 2 -
Charge the scanner	- 3 -
Warning Tone:	- 3 -
Get Battery Volume	- 3 -
Firmware Version	- 3 -
Barcode Programming	- 3 -
Connection Way	- 4 -
USB Wired Connection	- 4 -
1. USB HID Wired Connection	- 4 -
2. USB COM Port Emulation	- 4 -
USB Wireless Connection	- 4 -
1. USB Wireless connection (HID Mode)	- 4 -
2. USB DONGLE AS VIRTUAL COM	- 5 -
Bluetooth Connection	- 5 -
1. Bluetooth Basic Mode (HID) *	- 5 -
2. Applicatin Mode (Apple Specific Serial Profile)	- 5 -
3.Application Mode (Serial Port Profile)	- 6 -
• For Android or Windows	- 6 -
• Software installation is required	- 6 -
• If you have an application that supports this is the mode recommended.	- 6 -
Transmission Speed Via Bluetooth Connection	- 6 -
Scanning Mode:	- 7 -
*Trigger Mode (Default)	- 7 -
Auto Sense Mode	- 7 -
Continuous Mode	- 7 -
Keyboard Language	- 7 -
Data Uploading Mode	- 12 -
Quit Offline Mode	- 12 -
Offline Mode	- 12 -
Output Stored Data	- 12 -
Output Total Entry	- 12 -
Clear Memory	- 12 -
Get Battery Volume	- 13 -
Idle time	- 13 -
Convert Case	- 13 -
Terminator	- 14 -
IOS Keyboard POP UP/HIDE	- 15 -
Beeper	- 15 -
Restore factory default	- 15 -
Transmit Code ID Character	- 16 -
Symbol Code ID Identifiers	- 16 -
AIM Code Identifiers	- 17 -
All Symbologies	- 17 -
1D Symbologies	- 17 -
2D Symbologies	- 18 -
1D Inverse Barcode	- 18 -
Decode UPC/EAN Supplementals UPC/EAN	- 19 -
UPC-A	- 19 -

Enable/Disable UPC-A	19
Transmit Preamble Character	20
UPC-A Transmit Check Character	20
UPC-A Add-On Code	20
UPC-A Add-On Code Required	21
UPC-E	21
Enable/Disable UPC-E	21
Transmit Preamble Character	22
UPC-E Transmit Check Character	22
Convert UPC-E to UPC-A	22
UPC-E Add-On Code	22
UPC-E Add-On Code Required	23
EAN-8	23
Enable/Disable EAN-8	23
EAN-8 Extension	24
EAN-8 Add-On Code	24
EAN-8 Add-On Code Required	24
EAN-8 Transmit Check Character	25
EAN-13	25
Enable/Disable EAN-13	25
EAN-13 Add-On Code	25
EAN-13 Add-On Code Required	26
EAN-13 Transmit Check Character	26
Bookland EAN(ISBN)	26
Enable/Disable EAN(ISBN)	26
Bookland ISBN	27
Enable/Disable ISBN	27
Code 128	27
Enable/Disable Code 128	27
Code128 Transmit Check Character	28
GS1-128 (UCC/EAN-128)	28
Enable/Disable GS1-128 (UCC/EAN-128)	28
GS1-128 Transmit Check Character	28
ISBT 128	28
Enable/Disable ISBT 128	28
Code39	29
Enable/Disable Code 39	29
Set Length Range for Code39	29
One Discrete Length	29
Two Discrete Lengths	30
Length Within Range	30
Any Length	30
Code 39 Check Digit Verification	30
Transmit Code 39 Check Digit	31
Enable/Disable Code 39 Full ASCII	31
Code39 Transmit Start/Stop Character	32
Code 32	32
Enable/Disable Code 32	32
Code 32 Prefix	32
Code 93	33
Enable/Disable Code 93	33
Set Lengths for Code93	33
One Discrete Length	33
Two Discrete Lengths	33
Length Within Range	34
Any Length	34
Code 93 Check Digit Verification	34
Transmit Code 93 Check Digit	35

Code 11	- 35 -
Enable/Disable Code 11	- 35 -
Set Lengths for Code 11	- 35 -
One Discrete Length	- 35 -
Two Discrete Lengths	- 36 -
Length Within Range	- 36 -
Any Length	- 36 -
Code 11 Check Digit Verification	- 36 -
Transmit Code 11 Check Digits	- 37 -
Interleaved 2 of 5/ITF	- 37 -
Enable/Disable Interleaved 2 of 5	- 37 -
Set Lengths for Interleaved 2 of 5	- 38 -
One Discrete Length	- 38 -
Two Discrete Lengths	- 38 -
Length Within Range	- 38 -
Any Length	- 39 -
I 2 of 5 Check Digit Verification	- 39 -
Transmit I 2 of 5 Check Digit	- 39 -
ITF14	- 40 -
Enable/Disable ITF14	- 40 -
Transmit ITF14 Check Digit	- 40 -
Discrete 2 of 5/Industrial 2 of 5/IND25	- 41 -
Enable/Disable Discrete 2 of 5	- 41 -
Set Lengths for Discrete 2 of 5	- 41 -
One Discrete Length	- 41 -
Two Discrete Lengths	- 41 -
Length Within Range	- 42 -
Any Length	- 42 -
Discrete 2 of 5 Check Digit Verification	- 42 -
Transmit Discrete 2 of 5 Check Digit	- 42 -
Matrix 25	- 43 -
Enable/Disable Matrix 25	- 43 -
Matrix 25 Check Digit Verification	- 43 -
Transmit Matrix 25 Check Digit	- 44 -
Set Lengths for Matrix 25	- 44 -
One Discrete Length	- 44 -
Two Discrete Lengths	- 44 -
Length Within Range	- 45 -
Any Length	- 45 -
Standard 25/IATA 25	- 45 -
Enable/Disable Standard 25	- 45 -
Standard 25 Check Digit Verification	- 46 -
Standard 25 Transmit Check Character	- 46 -
Set Lengths for Standard 25	- 46 -
One Discrete Length	- 47 -
Two Discrete Lengths	- 47 -
Length Within Range	- 47 -
Any Length	- 47 -
Codabar	- 48 -
Enable/Disable Codabar	- 48 -
Set Lengths for Codabar	- 48 -
One Discrete Length	- 48 -
Two Discrete Lengths	- 48 -
Length Within Range	- 49 -
Any Length	- 49 -
Codabar Check Digit Verification	- 49 -
Codabar Transmit Check Character	- 49 -
Start/Stop Character Format	- 50 -
MSI	- 50 -

Enable/Disable MSI	- 50 -
Set Lengths for MSI	- 50 -
One Discrete Length	- 51 -
Two Discrete Lengths	- 51 -
Length Within Range	- 51 -
Any Length	- 51 -
MSI Check Character Verification	- 52 -
GS1 DataBar/RSS	- 52 -
Enable/Disable GS1 DataBar-14	- 52 -
Enable/Disable GS1 DataBar Limited	- 52 -
Enable/Disable GS1 DataBar Expanded	- 53 -
PDF417	- 53 -
Enable/Disable PDF417	- 53 -
PDF 417 Twin Code	- 54 -
Read Normal Phase/ Phase Reversal	- 54 -
QR	- 55 -
Enable/Disable QR	- 55 -
QR Twin Code	- 55 -
Enable/Disable QR ECI Output	- 56 -
Read Normal Phase/ Phase Reversal	- 56 -
Data Matrix(DM)	- 56 -
Enable/Disable Data Matrix(DM)	- 56 -
Data Matrix Twin Code	- 57 -
Enable/Disable Data Matrix ECI Output	- 57 -
Read Normal Phase/ Phase Reversal	- 58 -
Maxi Code	- 58 -
Enable/Disable Maxi Code	- 58 -
Aztec Code	- 58 -
Enable/Disable Aztec Code	- 59 -
Han Xin Code	- 59 -
Enable/Disable Han Xin Code	- 59 -
Han Xin Twin Code	- 59 -
Read Normal Phase/ Phase Reversal	- 60 -
Plessey	- 60 -
Enable/Disable Plessey	- 60 -
Check Character Verification	- 61 -
Transmit Check Character	- 61 -
Brazil Bank Code	- 61 -
Enable/Disable Brazil Bank Code	- 61 -
COMPOSITE	- 61 -
Enable/Disable COMPOSITE	- 61 -
EAN/UCC	- 62 -
Enable/Disable EAN/UCC	- 62 -
Appendix 1: Numeric Bar Codes	- 62 -
Cancel Barcode	- 64 -
Hide Prefix or suffix digits	- 64 -
Output Format	- 64 -
To Hide chars of barcode Start/Middle/End:	- 65 -
Numeric Bar Codes	- 66 -
Output Format	- 67 -
Table 1. ASCII Character Equivalents	- 71 -
Support	- 72 -
Contact Information	- 72 -

SCANNER SETUP GUIDE

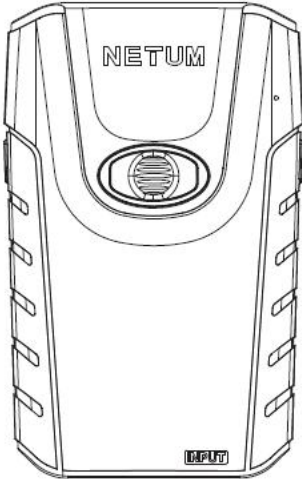

Product Description

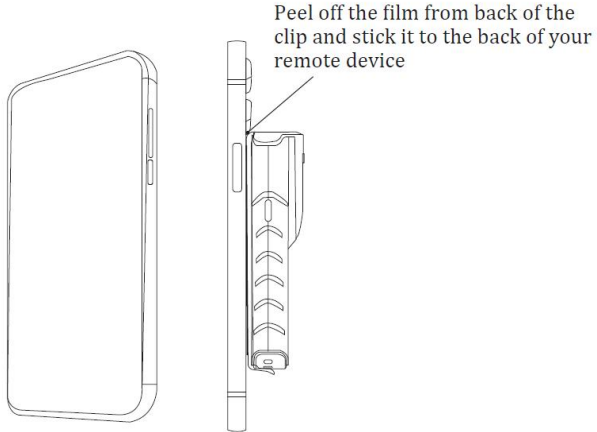
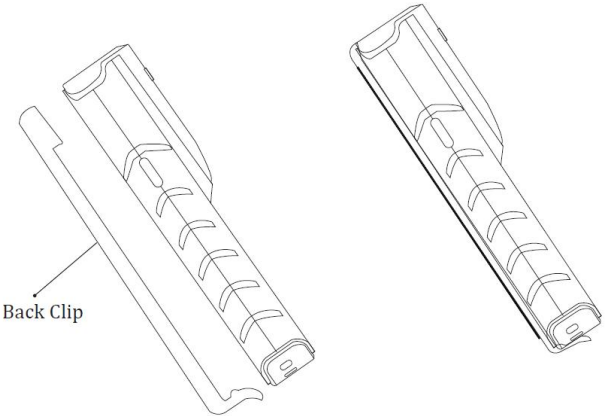
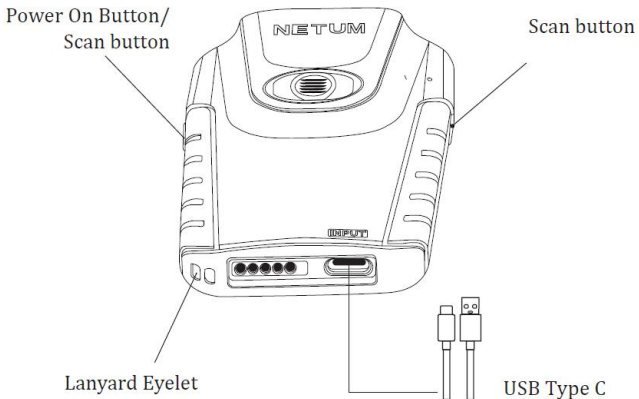
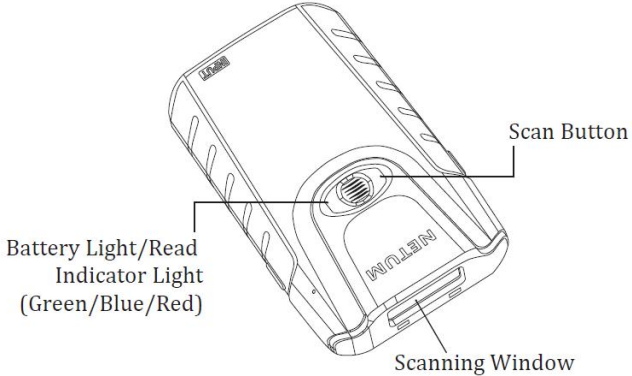

Charge the scanner

Connect Scanner with your host through USB cable (provided by Netum) or take a DC plug and charge it on an electrical wall outlet.

- Red Light - Charging
- Green Light - Fully charged
- Important Notes: DC Plug: V: 5V; A>500mA

Warning Tone:

Low battery warning - 2 beeps, LED in red flashing twice
Running out of battery - 5 beeps, LED in red flashing 5 times
Scanning will not read any barcodes when it's running out of battery.

Get Battery Volume

By scanning below command barcode will get rough battery volume.



Firmware Version

Read below command barcode to check scanner firmware version.



Barcode Programming

Netum barcode scanners are factory programmed for the most common terminal and communications settings. If you need to change these settings, programming is accomplished by scanning the bar codes in this guide. An asterisk (*) next to an option indicates the default setting.

Connection Way

Characters can be transmitted to your device via bluetooth, USB receiver or USB cable after each scanning, you can choose one of the connection ways to connect scanner with your device.

USB Wired Connection

1. USB HID Wired Connection

By default, the scanner is in HID mode as a Keyboard device. It works on a Plug and Play basis and no driver is required.

Steps on how to transmit characters via Type-C cable:

- 1) Connect scanner with your computer via type-C cable.
- 2) Press the power button.
- 3) Setup keyboard language, refer to page 7.
- 4) Locate cursor on the place where you want scanner to output the characters then you can start to scan.



*USB Cable as Keyboard (HID)

2. USB COM Port Emulation

If you connect scanner to the Host via a USB connection, by scanning below command barcode the USB COM Port Emulation feature allows the host to receive data in the way as a serial port does (no driver need for win 10 or above).



USB Cable as Virtual COM

USB Wireless Connection

1. USB Wireless connection (HID Mode)

Steps on how to transmit characters via USB Dongle (HID Mode):

- 1) Plug USB dongle into your computer.
- 2) Press the power button.
- 3) Setup keyboard language, refer to page 7.
- 4) Locate cursor on the place where you want scanner to output the characters then you can start to scan.



*USB Dongle as Keyboard(HID)

2. USB DONGLE AS VIRTUAL COM

Plug the USB dongle into your device, by scanning below command barcode, the USB COM Port Emulation feature will allow the host to receive data in the way as a serial port does. (no driver need for win 10 or above).



USB Dongle as Virtual COM

Bluetooth Connection

Steps on how to transmit characters via bluetooth HID mode:

- 1) Press power button.
- 2) Scan "Bluetooth Transmit".
- 3) Turn host device's Bluetooth on and find "E barcode scanner" from your bluetooth list, tap it and pair.
- 4) Setup keyboard language, refer to page 7.
- 5) Locate cursor on the place where you want scanner to output characters then you can start to scan.

Important Notes:

Make sure the device is in range with Bluetooth turned on.

If a connection is made, the blue light will stop blinking and turn solid.

If a connection is not made after several attempts, the scanner will emit a long beep (and the blue light will turn off).



Bluetooth Transmit

1. Bluetooth Basic Mode (HID) *

- NO software installation needed
- Connects to most devices
- Scanner interacts with host device like a keyboard



2. Application Mode (Apple Specific Serial Profile)

- For iOS Devices

- If you have an iOS application that supports our Scanners this is the mode to use.



AT+MODE=3

3.Application Mode (Serial Port Profile)

- For Android or Windows
- Software installation is required.
- If you have an application that supports this is the mode recommended.



AT+MODE=1

Transmission Speed Via Bluetooth Connection

By scanning the appropriate barcode will change bluetooth transmit speed



AT+HIDDL=10

High transmit speed



AT+HIDDL=45

Low transmit Speed

Scanning Mode:

*Trigger Mode (Default)

Scanning this bar code will enable the scanner to enter manual trigger mode.



2050200

Trigger Mode

Auto Sense Mode

Scanning this bar code will enable the scanner to enter auto sense mode.



2050209

Auto Sense Mode

Continuous Mode

This mode enables the engine to scan/capture, decode and transmit over and over again.



2050204

Continuous Mode

Keyboard Language

For example If you use French Keyboard, scan command barcode of “French keyboard ”. If you use a US keyboard you can ignore this step.



\$LAN#EN

* America EN keyboard



\$LAN#FR

French keyboard



\$LAN#GE

Germany keyboard



\$LAN#IT

Italy keyboard



\$LAN#PT

Portugal keyboard



\$LAN#ES

Spain keyboard



\$LAN#TK

Turkey Q keyboard



\$LAN#TF

Turkey F keyboard



\$LAN#UK

UK keyboard



\$LAN#CS

Czech keyboard



\$LAN#HU

Hungary keyboard



\$LAN#FB

Belgium FR keyboard



\$LAN#PB

Brazil PT keyboard



\$LAN#FC

Canadian FR keyboard



SLAN#HR

Croatia keyboard



SLAN#SK

Slovak keyboard



SLAN#DA

Denmark keyboard



SLAN#FI

Finland keyboard



SLAN#EL

Latin-America ES keyboard



SLAN#NL

Netherlands keyboard



SLAN#NO

Norway keyboard



Poland keyboard



Serbia keyboard



Slovenia keyboard



Sweden keyboard



Swiss DE keyboard

Data Uploading Mode

If you are heading for a working area which lies outside the Bluetooth signal range, you may activate scanner's store mode, following steps described below. Under this mode, all scanned data will be stored directly into the buffer memory of the device. Furthermore, the data entries will be permanently saved in the buffer memory prior to the manual upload into the working station, so that you may upload them when you are near your working device.

Quit Offline Mode

By scanning the following barcode, the device leaves the offline mode, normal mode will be reinitialised.



*Quit Offline Mode

Offline Mode

By scanning the following barcode, the offline mode will be activated



Offline Mode

Output Stored Data

By scanning the following barcode, all data entries in the buffer memory can be manually uploaded after reconnecting to the working station.



Output Stored Data

Output Total Entry

By scanning the following barcode, the gross quantity of the uploaded data entries will be summarised .



Output Total Entry

Clear Memory

By scanning the following barcode, all data in the buffer memory will be deleted.



Clear Memory

Get Battery Volume

Scan below command barcode to get battery rough volume



%BAT_VOL#

Battery Rough Volume

Idle time

Scanner will turn to sleep after idle/inactive for 1min

Scan "Disable module Idle time" before you doing any other setup from this section.



\$POWER#OFF

Power Off



\$RF#ST00

Disable Sleep Mode



\$RF#ST01

30S



\$RF#ST06

3Mins*



\$RF#ST60

30Min

Convert Case



* Disable Convert Case



Up Low Case Swap (A<->a)



All Upper Case (a->A)



All Lower Case (A->a)

Notes: Command barcodes from Working mode section are only applied for Bluetooth wireless mode,

Terminator

The scanner provides a shortcut for setting the terminating character suffix to CR or CRLF and enabling it by scanning the appropriate barcode below.



3030050

No Terminator



3030051

CR&LF *



3030052

CR



3030053

TAB

IOS Keyboard POP UP/HIDE

During the scanning IOS keyboard can be hidid or popped up by scanning below command barcode.



IOS Keyboard POP UP/HIDE

Beeper

Enable/Disable scanner to beep to indicate successful scan.



\$BUZZ#0
BEEP OFF



\$BUZZ#1
*High Volume



\$BUZZ#2
Middle Volume



\$BUZZ#3
Low Volume

Restore factory default

Scanning the following barcodes in order will reset the scanner. **(Four steps included)**

1.



303FFF0

2.



3.



4.



Transmit Code ID Character

A code ID character identifies the code type of a scanned bar code. This can be useful when decoding more than one code type. The code ID character is inserted between the prefix character (if selected) and the decoded symbol.



Symbol Code ID Character Code ID



Aim Code ID Character AIM ID



*None

Symbol Code ID Identifiers

A=	UPC-A, UPC-E, EAN-8, EAN-13	J=	MSI, MSI/Plessey
B=	Code 39, Code 32	K=	GS1-DataBar, /UCC/EAN-128
C=	Codabar	L=	Bookland EAN, Bookland EAN/ISBN
D=	Code 128, ISBT 128	M=	Trioptic Code 39
E=	Code 93	N=	Coupon Code
F=	Interleaved 2 of 5	R=	GS1 DataBar-14, GS1 DataBar Limited, GS1 DataBar Expanded, RSS

G=	Discrete 2 of 5	S=	SETUP128
H=	CODE11		

r=	PDF417	x=	Maxi Code
u=	DataMatrix(DM)	v=	Veri Code
q=	QR	c=	HanXin
a=	Aztec Code		

AIM Code Identifiers

Each AIM Code Identifier contains the three-character string]cm where:

] = Flag Character

c = Code Character (see *Table 4-4*)

m = Modifier Character

Table 4-4

A	Code 39, Code 39 Full ASCII, Code 32	S	Discrete 2 of 5, IATA 2 of 5
C	Code 128, ISBT 128, GS1-128, Coupon (Code 128 portion), Setup128	X	Code 39 Trioptic, Bookland EAN, Han Xin
E	UPC/EAN, Coupon (UPC portion)	e	GS1 DataBar
F	Codabar	L	PDF417
G	Code 93	d	Data Matrix(DM)
H	Code 11	Q	QR
I	Interleaved 2 of 5	z	Aztec Code

All Symbologies

Enable/Disable All Symbologies

If the **Disable All Symbologies** feature is enabled, the scanner will not be able to read any non-programming barcodes except the programming barcodes.



Disable All Symbologies



Enable All Symbologies

1D Symbologies

Enable/Disable 1D Symbologies

If the **Disable 1D Symbologies** feature is enabled, the scanner will not be able to read any 1D barcodes.



3030110

Disable 1D Symbologies



3030111

Enable 1D Symbologies

2D Symbologies

Enable/Disable 2D Symbologies

If the **Disable 2D Symbologies** feature is enabled, the scanner will not be able to read any 2D barcodes.



3030500

Disable 2D Symbologies



3030501

Enable 2D Symbologies

1D Inverse Barcode

Regular barcode: Dark image on a bright background.

Inverse barcode: Bright image on a dark background.



3030910

* Disable to read 1D reverse barcode



Enabled to read 1D reverse barcode

Decode UPC/EAN Supplementals UPC/EAN

Supplementals are bar codes appended according to specific format conventions (e.g. UPC A+2, UPC E+2, EAN 13+2, EAN 13+5). The following options are available:



*Ignore UPC/EAN with Supplementals



Decode UPC/EAN with Supplementals



Auto discriminate UPC/EAN Supplementals

UPC-A

Enable/Disable UPC-A

To enable or disable UPC-A, scan the appropriate bar code below.



*Enable UPC-A



1000010

Disable UPC-A

Transmit Preamble Character

Preamble characters (Country Code and System Character) can be transmitted as part of a UPC-A barcode. Select one of the following options for transmitting UPC-A preamble to the host device: transmit system character only or transmit system character and country code ("0" for USA).



2030100

No System Character



2030102

System Character & Country Code



2030101

* System Character

UPC-A Transmit Check Character



1020021

* Transmit UPC-A Check Character



1020020

Do Not Transmit UPC-A Check Character

UPC-A Add-On Code

A UPC-A barcode can be augmented with a two-digit or five-digit add-on code to form a new one.

Enable 2-Digit Add-On Code/ Enable 5-Digit Add-On Code: The scanner decodes a mix of UPC-A barcodes with and without 2-digit/5-digit add-on codes.

Disable 2-Digit Add-On Code/ Disable 5-Digit Add-On Code: The engine decodes UPC-A and ignores the add-on code when presented with a UPC-A plus add-on barcode. It can also decode UPC-A barcodes

without add-on codes.



Enable 2-Digit Add-On Code



*Disable 2-Digit Add-On Code



Enable 5-Digit Add-On Code



* Disable 5-Digit Add-On Code

UPC-A Add-On Code Required

When **UPC-A Add-On Code Required** is selected, the scanner will only read UPC-A barcodes that contain add-on codes.



UPC-A Add-On Code Required



* UPC-A Add-On Code Not Required

UPC-E

Enable/Disable UPC-E

To enable or disable UPC-E, scan the appropriate bar code below.



*Enable UPC-E



Disable UPC-E

Transmit Preamble Character

Preamble characters (Country Code and System Character) can be transmitted as part of a UPC-E barcode. Select one of the following options for transmitting UPC-E preamble to the host device: transmit system character only or transmit system character and country code ("0" for USA).



No System Character



System Character & Country Code



* System Character

UPC-E Transmit Check Character



* Transmit UPC-E Check Character



Do Not Transmit UPC-E Check Character

Convert UPC-E to UPC-A



Convert UPC-E to UPC-A



*Do not convert UPC-E to UPC-A

UPC-E Add-On Code

A UPC-E barcode can be augmented with a two-digit or five-digit add-on code to form a new one.

Enable 2-Digit Add-On Code/ Enable 5-Digit Add-On Code: The scanner decodes a mix of UPC-E barcodes with and without 2-digit/5-digit add-on codes.

Disable 2-Digit Add-On Code/ Disable 5-Digit Add-On Code: The scanner decodes UPC-E and ignores the add-on code when presented with a UPC-E plus add-on barcode. It can also decode UPC-E barcodes without add-on codes.



30303D1

Enable 2-Digit Add-On Code



30303D0

*Disable 2-Digit Add-On Code



30303E1

Enable 5-Digit Add-On Code



30303E0

* Disable 5-Digit Add-On Code

UPC-E Add-On Code Required

When **UPC-E Add-On Code Required** is selected, the scanner will only read UPC-E barcodes that contain add-on codes.



30303F1

UPC-E Add-On Code Required



30303F0

* UPC-E Add-On Code Not Required

EAN-8

Enable/Disable EAN-8

To enable or disable EAN-8, scan the appropriate bar code below.



1000041

*Enable EAN-8



1000040

Disable EAN-8

EAN-8 Extension

Disable EAN-8 Zero Extend: Transmit EAN-8 barcodes as is.

Enable EAN-8 Zero Extend: Add five leading zeros to decoded EAN-8 barcodes to extend to 13 digits.



Enable EAN-8 Zero Extend



*Disable EAN-8 Zero Extend

EAN-8 Add-On Code

A EAN-8 barcode can be augmented with a two-digit or five-digit add-on code to form a new one.

Enable 2-Digit Add-On Code/ Enable 5-Digit Add-On Code: The scanner decodes a mix of EAN-8 barcodes with and without 2-digit/5-digit add-on codes.

Disable 2-Digit Add-On Code/ Disable 5-Digit Add-On Code: The scanner decodes EAN-8 and ignores the add-on code when presented with a EAN-8 plus add-on barcode. It can also decode EAN-8 barcodes without add-on codes.



Enable 2-Digit Add-On Code



*Disable 2-Digit Add-On Code



Enable 5-Digit Add-On Code



*Disable 5-Digit Add-On Code

EAN-8 Add-On Code Required

When **EAN-8 Add-On Code Required** is selected, the scanner will only read EAN-8 barcodes that contain add-on codes.



EAN-8 Add-On Code Required



*EAN-8 Add-On Code Not Required

EAN-8 Transmit Check Character



* Transmit EAN-8 Check Character



Do Not Transmit EAN-8 Check Character

EAN-13

Enable/Disable EAN-13

To enable or disable EAN-13, scan the appropriate bar code below.



*Enable EAN-13



Disable EAN-13

EAN-13 Add-On Code

A EAN-13 barcode can be augmented with a two-digit or five-digit add-on code to form a new one.

Enable 2-Digit Add-On Code/ Enable 5-Digit Add-On Code: The scanner decodes a mix of EAN-13 barcodes with and without 2-digit/5-digit add-on codes.

Disable 2-Digit Add-On Code/ Disable 5-Digit Add-On Code: The scanner decodes EAN-13 and ignores the add-on code when presented with a EAN-13 plus add-on barcode. It can also decode EAN-13 barcodes without add-on codes.



Enable 2-Digit Add-On Code



*Disable 2-Digit Add-On Code



Enable 5-Digit Add-On Code



* Disable 5-Digit Add-On Code

EAN-13 Add-On Code Required

When **EAN-13 Add-On Code Required** is selected, the scanner will only read EAN-13 barcodes that contain add-on codes.



EAN-13 Add-On Code Required



*EAN-13 Add-On Code Not Required

EAN-13 Transmit Check Character



* Transmit EAN-13 Check Character



Do Not Transmit EAN-13 Check Character

Bookland EAN(ISBN)

Enable/Disable EAN(ISBN)

To enable or disable EAN Bookland, scan the appropriate bar code below.



Enable Bookland EAN



*Disable Bookland EAN

Bookland ISBN

Enable/Disable ISBN

To enable or disable Bookland ISBN, scan the appropriate bar code below.



*Bookland ISBN-10



Bookland ISBN-13

Code 128

Enable/Disable Code 128

To enable or disable Code 128, scan the appropriate bar code below.



*Enable Code 128



Disable Code 128

Code128 Transmit Check Character



Transmit Code128 Check Character



* Do Not Transmit Code128 Check Character

GS1-128 (UCC/EAN-128)

Enable/Disable GS1-128 (UCC/EAN-128)

To enable or disable GS1-128, scan the appropriate bar code below.



*Enable GS1-128



Disable GS1-128

GS1-128 Transmit Check Character



Transmit GS1-128 Check Character



* Do Not Transmit GS1-128 Check Character

ISBT 128

Enable/Disable ISBT 128

To enable or disable ISBT 128, scan the appropriate bar code below.



*Enable ISBT 128



Disable ISBT 128

Code39

Enable/Disable Code 39

To enable or disable Code 39, scan the appropriate bar code below.



*Enable Code 39



Disable Code 39

Set Length Range for Code39

The length of a code refers to the number of characters (i.e., human readable characters), including check digit(s) the code contains. Lengths for Code 39 may be set for any length, one or two discrete lengths, or lengths within a specific range.

NOTE When setting lengths, single digit numbers must always be preceded by a leading zero.

One Discrete Length

This option limits decodes to only those Code 39 symbols containing a selected length. Lengths are selected from the *Numeric Bar Codes* in appendix. For example, to decode only Code 39 symbols with 14 characters, scan Code 39 - One Discrete Length, then scan 1 followed by 4. To change the selection or cancel an incorrect entry, scan *Cancel* in appendix.



Code 39 - One Discrete Length

Two Discrete Lengths

This option limits decodes to only those Code 39 symbols containing either of two selected lengths. Lengths are selected from the *Numeric Bar Codes* in appendix. For example, to decode only those Code 39 symbols containing either 2 or 14 characters, select **Code 39 - Two Discrete Lengths**, then scan **0, 2, 1**, and then **4**. To change the selection or cancel an incorrect entry, scan *Cancel* in appendix.



Code 39 - Two Discrete Lengths

Length Within Range

This option limits decodes to only those Code 39 symbols within a specified range. For example, to decode Code 39 symbols containing between 4 and 12 characters, first scan **Code 39 - Length Within Range**. Then scan **0, 4, 1**, and **2** according to *Numeric Bar Codes* in appendix. To change the selection or cancel an incorrect entry, scan *Cancel* in appendix.



Code 39 - Length Within Range

Any Length

Scan this option to decode Code 39 symbols containing any number of characters



Code 39 - Any Length

Code 39 Check Digit Verification

When this feature is enabled, the scan engine checks the integrity of all Code 39 symbols to verify that the data complies with specified check digit algorithm. Only those Code 39 symbols which include a modulo 43 check digit are decoded. Only enable this feature if your Code 39 symbols contain a module 43 check digit.



Verify Code 39 Check Digit



*Do Not Verify Code 39 Check Digit

Transmit Code 39 Check Digit

Scan this symbol to transmit the check digit with the data.



Transmit Code 39 Check Digit (Enable)

Scan this symbol to transmit data without the check digit.



*Do Not Transmit Code 39 Check Digit

Enable/Disable Code 39 Full ASCII

Code 39 Full ASCII is a variant of Code 39 which pairs characters to encode the full ASCII character set.



Enable Code 39 Full ASCII



*Disable Code 39 Full ASCII

NOTE Trioptic Code 39 and Code 39 Full ASCII cannot be enabled simultaneously. If you get an error beep when enabling Code 39 Full ASCII, disable Trioptic Code 39 and try again.

Code39 Transmit Start/Stop Character



Transmit Start/Stop Character



** Do not Transmit Start/Stop Character

Code 32

Enable/Disable Code 32

Code 32 is a variant of Code 39 used by the Italian pharmaceutical industry. Scan the appropriate bar code below to enable or disable Code 32. Code 39 must be enabled and Code 39 check character verification must be disabled for this parameter to function.



* Disable Code 32



Enable Code 32

Code 32 Prefix

Scan the appropriate bar code below to enable or disable adding the prefix character "A" to all Code 32 barcodes. Code 32 must be enabled for this parameter to function.



* Disable Code 32 Prefix



Enable Code 32 Prefix

Code 93

Enable/Disable Code 93

To enable or disable Code 93, scan the appropriate bar code below.



Enable Code 93



*Disable Code 93

Set Lengths for Code93

The length of a code refers to the number of characters (i.e., human readable characters), including check digit(s) the code contains. Lengths for Code 93 may be set for any length, one or two discrete lengths, or lengths within a specific range.

One Discrete Length

Select this option to decode only those codes containing a selected length. For example, select **Code 93 One Discrete Length**, then scan **1, 4**, to limit the decoding to only Code 93 symbols containing 14 characters. *Numeric Bar Codes* is in appendix. To change the selection or cancel an incorrect entry, scan *Cancel* in appendix



Code 93 - One Discrete Length

Two Discrete Lengths

Select this option to decode only those codes containing two selected lengths. For example, select **Code 93 Two Discrete Lengths**, then scan **0, 2, 1, 4**, to limit the decoding to only Code 93 symbols containing 2 or 14 characters. *Numeric Bar Codes* is in appendix. To change the selection or cancel an incorrect entry, scan *Cancel* in appendix.



Code 93 - Two Discrete Lengths

Length Within Range

This option sets the unit to decode a code type within a specified range. For example, to decode Code 93 symbols containing between 4 and 12 characters, first scan **Code 93 Length Within Range**, then scan **0, 4, 1** and **2** (single digit numbers must always be preceded by a leading zero). *Numeric Bar Codes* is in appendix. To change the selection or cancel an incorrect entry, scan *Cancel* in appendix..



Code 93 - Length Within Range

Any Length

Scan this option to decode Code 93 symbols containing any number of characters



Code 93 - Any Length

Code 93 Check Digit Verification



*Verify Code 93 Check Digit



Do Not Verify Code 39 Check Digit

Transmit Code 93 Check Digit



Transmit Code 93 Check Digit (Enable)



*Do Not Transmit Code 93 Check Digit

Code 11

Enable/Disable Code 11

To enable or disable Code 11, scan the appropriate bar code below.



Enable Code 11



*Disable Code 11

Set Lengths for Code 11

The length of a code refers to the number of characters (i.e., human readable characters), including check digit(s) the code contains. Set lengths for Code 11 to any length, one or two discrete lengths, or lengths within a specific range

One Discrete Length

Select this option to decode only Code 11 symbols containing a selected length. Select the length using the *Numeric Bar Codes* in appendix. For example, to decode only Code 11 symbols with 14 characters, scan **Code 11 - One Discrete Length**, then scan **1** followed by **4**. To correct an error or to change the selection, scan *Cancel* in appendix.



Code 11 - One Discrete Length

Two Discrete Lengths

Select this option to decode only Code 11 symbols containing either of two selected lengths. Select lengths using the *Numeric Bar Codes* in appendix. For example, to decode only those Code 11 symbols containing either 2 or 14 characters, select **Code 11 - Two Discrete Lengths**, then scan **0, 2, 1**, and then **4**. To correct an error or to change the selection, scan *Cancel* in appendix.



Code 11 - Two Discrete Lengths

Length Within Range

Select this option to decode a Code 11 symbol with a specific length range. Select lengths using the *Numeric Bar Codes* in appendix. For example, to decode Code 11 symbols containing between 4 and 12 characters, first scan **Code 11 - Length Within Range**. Then scan **0, 4, 1**, and **2** (single digit numbers must always be preceded by a leading zero). To correct an error or change the selection, scan *Cancel* in appendix.



Code 11 - Length Within Range

Any Length

Scan this option to decode Code 11 symbols containing any number of characters within the scan engine capability.



Code 11 - Any Length

Code 11 Check Digit Verification

This feature allows the scan engine to check the integrity of all Code 11 symbols to verify that the data complies with the specified check digit algorithm. This selects the check digit mechanism for the decoded Code 11 bar code. The options are to check for one check digit, check for two check digits, or disable the feature.



* Disable Code 11 Check Digit Verification



Enable One Check Digit



Enable Two Check Digits

Transmit Code 11 Check Digits



Transmit Code 11 Check Digit(s) (Enable)



*Do Not Transmit Code 11 Check Digit(s) (Disable)

Interleaved 2 of 5/ITF

Enable/Disable Interleaved 2 of 5

To enable or disable Interleaved 2 of 5, scan the appropriate bar code below.



*Enable Interleaved 2 of 5



Disable Interleaved 2 of 5

Set Lengths for Interleaved 2 of 5

The length of a code refers to the number of characters (i.e., human readable characters), including check digit(s) the code contains. Lengths for I 2 of 5 may be set for any length, one or two discrete lengths, or lengths within a specific range.

One Discrete Length

Select this option to decode only those codes containing a selected length. For example, select **I 2 of 5 One Discrete Length**, then scan **1, 4**, to decode only D 2 of 5 symbols containing 14 characters. *Numeric Bar Codes* is in appendix. To change the selection or cancel an incorrect entry, scan *Cancel* in appendix.



I 2 of 5 - One Discrete Length

Two Discrete Lengths

Select this option to decode only those codes containing two selected lengths. For example, select **I 2 of 5 Two Discrete Lengths**, then scan **0, 6, 1, 4**, to decode only I 2 of 5 symbols containing 6 or 14 characters. *Numeric Bar Codes* is in appendix. To change the selection or cancel an incorrect entry, scan *Cancel* in appendix.



I 2 of 5 - Two Discrete Lengths

Length Within Range

Select this option to decode only codes within a specified range. For example, to decode I 2 of 5 symbols containing between 4 and 12 characters, first scan **I 2 of 5 Length Within Range**, then scan **0, 4, 1** and **2** (single digit numbers must always be preceded by a leading zero). *Numeric Bar Codes* is in appendix. To change the

selection or cancel an incorrect entry, scan *Cancel* in appendix.



I 2 of 5 - Length Within Range

Any Length

Scan this option to decode I 2 of 5 symbols containing any number of characters.

NOTE Selecting this option may lead to misdecodes for I 2 of 5 codes



I 2 of 5 - Any Length

I 2 of 5 Check Digit Verification



Verify I 2 of 5 Check Digit



*Do Not Verify I 2 of 5 Check Digit

Transmit I 2 of 5 Check Digit



Transmit I 2 of 5 Check Digit (Enable)



*Do Not Transmit I 2 of 5 Check Digit

ITF14

Enable/Disable ITF14

To enable or disable ITF14, scan the appropriate bar code below.



Enable ITF14



*Disable ITF14

Transmit ITF14 Check Digit



Transmit ITF14 Check Digit (Enable)



*Do Not Transmit ITF14 Check Digit

Discrete 2 of 5/Industrial 2 of 5/IND25

Enable/Disable Discrete 2 of 5

To enable or disable Discrete 2 of 5, scan the appropriate bar code below.



Enable Discrete 2 of 5



*Disable Discrete 2 of 5

Set Lengths for Discrete 2 of 5

The length of a code refers to the number of characters (i.e., human readable characters), including check digit(s) the code contains. Lengths for D 2 of 5 may be set for any length, one or two discrete lengths, or lengths within a specific range.

One Discrete Length

Select this option to decode only those codes containing a selected length. For example, select **D 2 of 5 One Discrete Length**, then scan **1, 4**, to decode only D 2 of 5 symbols containing 14 characters. *Numeric Bar Codes* is in appendix. To change the selection or cancel an incorrect entry, scan *Cancel* in appendix.



D 2 of 5 - One Discrete Length

Two Discrete Lengths

Select this option to decode only those codes containing two selected lengths. For example, select **D 2 of 5 Two Discrete Lengths**, then scan **0, 2, 1, 4**, to decode only D 2 of 5 symbols containing 2 or 14 characters. *Numeric Bar Codes* is in appendix. To change the selection or cancel an incorrect entry, scan *Cancel* in appendix.



D 2 of 5 - Two Discrete Lengths

Length Within Range

Select this option to decode codes within a specified range. For example, to decode D 2 of 5 symbols containing between 4 and 12 characters, first scan **D 2 of 5 Length Within Range**, then scan **0, 4, 1** and **2** (single digit numbers must be preceded by a leading zero). *Numeric Bar Codes* is in appendix. To change the selection or cancel an incorrect entry, scan *Cancel* in appendix.



D 2 of 5 - Length Within Range

Any Length

Scan this option to decode D 2 of 5 symbols containing any number of characters.

NOTE Selecting this option may lead to misdecodes for D 2 of 5 codes.



D 2 of 5 - Any Length

Discrete 2 of 5 Check Digit Verification



Verify D 2 of 5 Check Digit



*Do Not Verify D 2 of 5 Check Digit

Transmit Discrete 2 of 5 Check Digit



Transmit D 2 of 5 Check Digit (Enable)



*Do Not Transmit D 2 of 5 Check Digit

Matrix 25

Enable/Disable Matrix 25

To enable or disable Matrix 25, scan the appropriate bar code below.



Enable Matrix 25



*Disable Matrix 25

Matrix 25 Check Digit Verification



Verify Matrix 25 Check Digit



*Do Not Verify Matrix 25 Check Digit

Transmit Matrix 25 Check Digit



Transmit Matrix 25 Check Digit (Enable)



*Do Not Transmit Matrix 25 Check Digit

Set Lengths for Matrix 25

The length of a code refers to the number of characters (i.e., human readable characters), including check digit(s) the code contains. Lengths for Matrix 25 may be set for any length, one or two discrete lengths, or lengths within a specific range.

One Discrete Length

Select this option to decode only those codes containing a selected length. For example, select Matrix 25 One Discrete Length, then scan 1, 4, to decode only Matrix 25 symbols containing 14 characters. *Numeric Bar Codes* is in appendix. To change the selection or cancel an incorrect entry, scan *Cancel* in appendix.



Matrix 25 - One Discrete Length

Two Discrete Lengths

Select this option to decode only those codes containing two selected lengths. For example, select **Matrix 25 Two Discrete Lengths**, then scan **0, 2, 1, 4**, to decode only Matrix 25 symbols containing 2 or 14 characters. *Numeric Bar Codes* is in appendix. To change the selection or cancel an incorrect entry, scan *Cancel* in appendix.



Matrix 25 - Two Discrete Lengths

Length Within Range

Select this option to decode codes within a specified range. For example, to decode Matrix 25 symbols containing between 4 and 12 characters, first scan **Matrix 25 Length Within Range**, then scan **0, 4, 1** and **2** (single digit numbers must be preceded by a leading zero). *Numeric Bar Codes* is in appendix. To change the selection or cancel an incorrect entry, scan *Cancel* in appendix.



Matrix 25 - Length Within Range

Any Length

Scan this option to decode Matrix 25 symbols containing any number of characters.

NOTE Selecting this option may lead to misdecodes for Matrix 25 codes.



Matrix 25 - Any Length

Standard 25/IATA 25

Enable/Disable Standard 25

To enable or disable Standard 25, scan the appropriate bar code below.



*Disable Standard 25



Enable Standard 25

Standard 25 Check Digit Verification



*Disable Standard 25 Check Digit Verification



Enable Standard 25 Check Digit Verification

Standard 25 Transmit Check Character



*Disable Standard 25 Transmit Check Character



Enable Standard 25 Transmit Check Character

Set Lengths for Standard 25

The length of a code refers to the number of characters (i.e., human readable characters), including check digit(s) the code contains. Lengths for Standard 25 may be set for any length, one or two discrete lengths, or lengths within a specific range.

One Discrete Length

Select this option to decode only those codes containing a selected length. For example, select **Standard 25 One Discrete Length**, then scan **1, 4**, to decode only Standard 25 symbols containing 14 characters. *Numeric Bar Codes* is in appendix. To change the selection or cancel an incorrect entry, scan *Cancel* in appendix.



Standard 25 - One Discrete Length

Two Discrete Lengths

Select this option to decode only those codes containing two selected lengths. For example, select **Standard 25 Two Discrete Lengths**, then scan **0, 2, 1, 4**, to decode only Standard 25 symbols containing 2 or 14 characters. *Numeric Bar Codes* is in appendix. To change the selection or cancel an incorrect entry, scan *Cancel* in appendix.



Standard 25 - Two Discrete Lengths

Length Within Range

Select this option to decode codes within a specified range. For example, to decode Standard 25 symbols containing between 4 and 12 characters, first scan **Standard 25 Length Within Range**, then scan **0, 4, 1** and **2** (single digit numbers must be preceded by a leading zero). *Numeric Bar Codes* is in appendix. To change the selection or cancel an incorrect entry, scan *Cancel* in appendix.



Standard 25 - Length Within Range

Any Length

Scan this option to decode Standard 25 symbols containing any number of characters.
NOTE Selecting this option may lead to misdecodes for Standard 25 codes.



Standard 25 - Any Length

Codabar

Enable/Disable Codabar

To enable or disable Codabar, scan the appropriate bar code below.



Enable Codabar



*Disable Codabar

Set Lengths for Codabar

The length of a code refers to the number of characters (i.e., human readable characters), including check digit(s) the code contains. Lengths for Codabar may be set for any length, one or two discrete lengths, or lengths within a specific range.

One Discrete Length

Select this option to decode only those codes containing a selected length. For example, select **Codabar One Discrete Length**, then scan **1, 4**, to decode only Codabar symbols containing 14 characters. *Numeric Bar Codes* is in appendix. To change the selection or cancel an incorrect entry, scan *Cancel* in appendix.



Codabar - One Discrete Length Codabar

Two Discrete Lengths

This option sets the unit to decode only those codes containing two selected lengths. For example, select **Codabar Two Discrete Lengths**, then scan **0, 2, 1, 4**, to decode only Codabar symbols containing 6 or 14 characters. *Numeric Bar Codes* is in appendix. To change the selection or cancel an incorrect entry, scan *Cancel* in appendix.



Codabar - Two Discrete Lengths Codabar

Length Within Range

Select this option to decode a code within a specified range. For example, to decode Codabar symbols containing between 4 and 12 characters, first scan **Codabar Length Within Range**, then scan **0, 4, 1** and **2** (single digit numbers must always be preceded by a leading zero). *Numeric Bar Codes* is in appendix. To change the selection or cancel an incorrect entry, scan *Cancel* in appendix



Codabar - Length Within Range Codabar -

Any Length

Scan this option to decode Codabar symbols containing any number of characters.



Codabar - Any Length Codabar

Codabar Check Digit Verification



*Disable Codabar Check Digit Verification



Enable Codabar Check Digit Verification

Codabar Transmit Check Character



*Disable Codabar Transmit Check Character



30304D1

Enable Codabar Transmit Check Character

Start/Stop Character Format

You can choose your desired start/stop character format by scanning the appropriate barcode below.



3030310

* ABCD/ABCD as the Start/Stop Character



3030311

ABCD/TN*E as the Start/Stop Character



3030320

*Start/Stop Character in Uppercase



3030321

Start/Stop Character in Lowercase

MSI

Enable/Disable MSI

To enable or disable MSI, scan the appropriate bar code below.



1000141

Enable MSI



1000140

*Disable MSI

Set Lengths for MSI

The length of a code refers to the number of characters (i.e., human readable characters) the code contains, and includes check digits. Lengths for MSI can be set for any length, one or two discrete lengths, or lengths within a specific range.

One Discrete Length

Select this option to decode only those codes containing a selected length. For example, select MSI Plessey One Discrete Length, then scan 1, 4, to decode only MSI Plessey symbols containing 14 characters. *Numeric Bar Codes is in Appendix.*



MSI - One Discrete Length

Two Discrete Lengths

Select this option to decode only those codes containing two selected lengths. For example, select **MSI Plessey Two Discrete Lengths**, then scan **0, 6, 1, 4**, to decode only MSI Plessey symbols containing 6 or 14 characters. *Numeric Bar Codes is in appendix.* To change the selection or cancel an incorrect entry, scan *Cancel* in appendix



MSI - Two Discrete Lengths

Length Within Range

Select this option to decode codes within a specified range. For example, to decode MSI symbols containing between 4 and 12 characters, first scan **MSI Length Within Range**, then scan **0, 4, 1** and **2** (single digit numbers must always be preceded by a leading zero). *Numeric Bar Codes is in appendix.* To change the selection or cancel an incorrect entry, scan *Cancel* in appendix.



MSI - Length Within Range

Any Length

Scan this option to decode MSI Plessey symbols containing any number of characters. **NOTE** Selecting this option may lead to misdecodes for MSI codes.



MSI - Any Length

MSI Check Character Verification



* One Check Character

MSI Transmit Check Character



Two Check Characters



Transmit Check Character



* Do Not Transmit Check Character

GS1 DataBar/RSS

Enable/Disable GS1 DataBar-14

To enable or disable GS1 DataBar-14, scan the appropriate bar code below.



Enable GS1 DataBar-14



*Disable GS1 DataBar-14

Enable/Disable GS1 DataBar Limited

To enable or disable GS1 DataBar Limited, scan the appropriate bar code below.



Enable GS1 DataBar Limited



*Disable GS1 DataBar Limited

Enable/Disable GS1 DataBar Expanded

To enable or disable GS1 DataBar Expanded, scan the appropriate bar code below.



Enable GS1 DataBar Expanded



*Disable GS1 DataBar Expanded

PDF417

Enable/Disable PDF417

To enable or disable PDF417, scan the appropriate bar code below.



Disable PDF417



*Enable PDF417

PDF 417 Twin Code

PDF417 twin code is 2 PDF417 barcodes paralleled vertically or horizontally. They must both be either regular or inverse barcodes. They must have similar specifications and be placed closely together. There are 3 options for reading PDF417 twin codes:

Single PDF417 Only: Read either PDF417 code.

Twin PDF417 Only: Read both PDF417 codes.

Both Single & Twin: Read both PDF417 codes. If successful, transmit as twin PDF417 only. Otherwise, try single PDF417 only.



*Single PDF417 Only



Twin PDF417 Only



Both Single & Twin

Read Normal Phase/ Phase Reversal



*Read Normal Phase



Read Phase Reversal



Read Normal Phase/ Phase Reversal

QR

Read normal phase/ phase reversal/ mirror image picture

Enable/Disable QR

To enable or disable QR, scan the appropriate bar code below.



Disable QRCode



*Enable QR Code

QR Twin Code



*Single QR Only



Twin QR Only



3030652

Both Single & Twin

Enable/Disable QR ECI Output



3030660

*Disable QR ECI Output



3030661

Enable QR ECI Output

Read Normal Phase/ Phase Reversal



3030670

*Read Normal Phase



3030671

Read Phase Reversal



3030672

Read Normal Phase/ Phase Reversal

Data Matrix(DM)

Scan normal or mirror image picture.

Enable/Disable Data Matrix(DM)

To enable or disable Data Matrix(DM), scan the appropriate bar code below.



1003240

Disable Data Matrix



1003241

*Enable Data Matrix

Data Matrix Twin Code



30306A0

*Single Data Matrix Only



30306A1

Twin Data Matrix Only



30306A2

Both Single & Twin

Enable/Disable Data Matrix ECI Output



30306C0

*Disable Data Matrix ECI Output



30306C1

Enable Data Matrix ECI Output

Read Normal Phase/ Phase Reversal



*Read Normal Phase



Read Phase Reversal



Read Normal Phase/ Phase Reversal

Maxi Code

Enable/Disable Maxi Code

To enable or disable Maxi Code, scan the appropriate bar code below.



*Disable MaxiCode



Enable MaxiCode

Aztec Code

Enable/Disable Aztec Code

To enable or disable Aztec Code, scan the appropriate bar code below.



*Disable Aztec Code



Enable Aztec Code

Han Xin Code

Enable/Disable Han Xin Code

To enable or disable Han Xin Code, scan the appropriate bar code below.



*Disable Han Xin Code



Enable Han Xin Code

Han Xin Twin Code



*Single Han Xin Only



Twin Han Xin Only



Both Single & Twin

Read Normal Phase/ Phase Reversal



*Read Normal Phase



Read Phase Reversal



Read Normal Phase/ Phase Reversal

Plessey

Enable/Disable Plessey

To enable or disable Plessey, scan the appropriate bar code below.



Enable Plessey



*Disable Plessey

Check Character Verification



Enable Character Verification



* Disable Character Verification

Transmit Check Character



Transmit Check Character



* Do Not Transmit Check Character

Brazil Bank Code

Enable/Disable Brazil Bank Code

Only applied to 1D barcode, To enable or disable Han Xin Code, scan the appropriate bar code below.



Enable Brazil Bank Code



* Disable Brazil Bank Code

COMPOSITE

Enable/Disable COMPOSITE

To enable or disable Plessey, scan the appropriate bar code below.



3030171

Enable COMPOSITE Code



3030170

* Disable COMPOSITE Code

EAN/UCC

Enable/Disable EAN/UCC

To enable or disable EAN/UCC, scan the appropriate bar code below.



3030181

Enable EAN/UCC Code



3030180

* Disable EAN/UCC Code

Appendix 1: Numeric Bar Codes



0



1



2



3



4



5



6



7

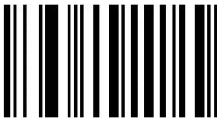

8

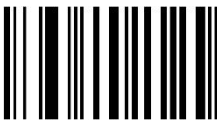

9

Cancel Barcode

To change the selection or cancel an incorrect entry, scan the barcode below.



Cancel

Hide Prefix or suffix digits

The start/middle/end of barcode chars can be hidden. After scan below hide set barcode, scan a double-digit hexadecimal number that you want to hide char length(00~FF e.g. hide length 4, scan 0, 4).



\$SCAN#5

Hide Barcode Start Chars



\$SCAN#6

Hide Barcode Middle Char Start



\$SCAN#7

Hide Barcode Middle Chars



\$SCAN#8

Hide Barcode End Chars

Output Format

To change the Scan Data Transmission Format, scan one of the eight bar codes corresponding to the desired format.



\$DATA#5

Enable Hide Barcode Start Char



\$DATA#4

Enable Hide Barcode Middle Char



\$DATA#3

Enable Hide Barcode End Char

To Hide chars of barcode Start/Middle/End: Procedures

1. Scan the Hide Barcode Start / Middle Start / Middle length / End Chars symbol.
2. Determine the hex value for the length you wish to enter(hide 4 chars, scan 0,4; hide 12 chars, scan 0,C).
3. Scan the 2 digit hex value from the **Numeric Bar Codes**
4. Scan the output format to enable or cancel hide char function.

Custom prefix and suffix

Maximum 20 prefixes and 20 suffixes can be added to scan data for use in data editing. To set these values, scan a double-digit hexadecimal number (i.e. two bar codes) that corresponds to ASCII values. See the [Table 1](#) and [Numeric Bar Codes](#) in appendix.

To Add a Prefix or Suffix:

1. Scan command barcode of " Add Prefix" or" Add Suffix ".
2. Check the prefix or suffix hex value from the ASCII Chart.
3. Scan the 2 digit hex value from the Numeric Bar Codes
4. Repeat Steps 2 and 3 for all the prefix or suffix that you want to add.
5. Scan the output format to enable or disable prefix/suffix output.



\$SCAN#2

Add Prefix



\$SCAN#1

Add Suffix



\$SCAN#4

Clear All Prefix



\$SCAN#3

Clear All Suffix

Numeric Bar Codes



\$NO#0



\$NO#1



\$NO#2



\$NO#3



\$NO#4



\$NO#5



\$NO#6



\$NO#7



\$NO#8



Output Format

To change the Scan Data Transmission Format, scan one of the eight bar codes corresponding to the desired format.



*Default output format



Enable Suffix output



\$DATA#2

Enable Prefix output

Example on how to add normal prefix or suffix on barcode "123456789"



123456789

Add " A" and "B" as prefixes and "!" as suffix

1. Scan command barcode of " Add Prefix"



\$SCAN#2

2. Check the prefix hex value from the ASCII Chart. A- "4", "1"; B-"4" "2";

3. Scan the 2 digit hex value from the Numeric Bar Codes



\$NO#4



\$NO#1



\$NO#4



\$NO#2

4. Scan the output format to enable prefix output.



\$DATA#2

Enable Prefix output

5. Scan command barcode of " Add Suffix" to add "!" as suffix.



\$SCAN#1

Add Suffix

6. Check the suffix hex value from the ASCII Chart. !- "2" "1"

7. Scan the 2 digit hex value from the Numeric Bar Codes.



\$NO#2



\$NO#1

8. Scan the output format to enable suffix output.



\$DATA#1

Enable Suffix output

9. Scan the barcode then you will get **AB123456789!**

Example on how to add Combination Key suffix for barcode "123456789"



123456789

Add "Ctrl+P" on "123456789" as suffix

1. Scan command barcode of " Add Suffix" to add "Ctrl+P" as suffix.



\$SCAN#1

Add Suffix

2. Check the suffix hex value from the ASCII Chart. **Ctrl+P** - "9" "7" "5" "0"

3. Scan the 4 digits hex value from the Numeric Bar Codes.



\$NO#9



\$NO#7



\$NO#5



\$NO#0

4. Scan the output format to enable suffix output.



\$DATA#1

Enable Suffix output

5. Scan the barcode **123456789**. (test it on Excel)

Table 1. ASCII Character Equivalents

HEX	ASCII	HEX	ASCII	HEX	ASCII	HEX	ASCII
20H	Space	30H	0	40H	@	50H	P
21H	!	31H	1	41H	A	51H	Q
22H	"	32H	2	42H	B	52H	R
23H	#	33H	3	43H	C	53H	S
24H	\$	34H	4	44H	D	54H	T
25H	%	35H	5	45H	E	55H	U
26H	&	36H	6	46H	F	56H	V
27H	'	37H	7	47H	G	57H	W
28H	(38H	8	48H	H	58H	X
29H)	39H	9	49H	I	59H	Y
2AH	*	3AH	:	4AH	J	5AH	Z
2BH	+	3BH	;	4BH	K	5BH	[
2CH	,	3CH	<	4CH	L	5CH	\
2DH	-	3DH	=	4DH	M	5DH]
2EH	.	3EH	>	4EH	N	5EH	^
2FH	/	3FH	?	4FH	O	5FH	_
60H	`	70H	p	80H	F1	90H	End
61H	a	71H	q	81H	F2	91H	Page Down
62H	b	72H	r	82H	F3	92H	Right Arrow
63H	c	73H	s	83H	F4	93H	Left Arrow
64H	d	74H	t	84H	F5	94H	Down Arrow
65H	e	75H	u	85H	F6	95H	Up Arrow
66H	f	76H	v	86H	F7	96H	Print Screen
67H	g	77H	w	87H	F8	97H	*Ctrl
68H	h	78H	x	88H	F9	98H	*Shirt
69H	i	79H	y	89H	F10	99H	*Left Alt
6AH	J	7AH	z	8AH	F11	9AH	*Right Alt
6BH	k	7BH	{	8BH	F12	08H	BS
6CH	l	7CH		8CH	Insert	09H	HT
6DH	m	7DH	}	8DH	Home	0AH	LF
6EH	n	7EH	~	8EH	Page Up	0DH	CR
6FH	o	7FH	DEL	8FH	Delete	1BH	ESC

Support

For any inquiries concerning our products, please send an email to service@netum.net, and we will respond to you as soon as possible.

Contact Information

Tel.:+0086 20-3222-8813

Email: service@netum.net

Address:

301,6 3/F, Building 1, No. 51 ,Xiangshan Avenue, Ningxi ST,
Zengcheng, GZ
China 511340

Made in China