



LED Module Flood Light

M-II



www.ofled-lighting.en.alibaba.com

115-140
lm/W

- Light Efficacy up to 115-140Lm/W
- Input Voltage: 100-240VAC or 100-277VAC
- 5 years warranty.
- High-efficiency radiating aluminum material,
- smaller size, cost-effective.



Jiangsu Ofled Optoelectronics Technology Co.,Ltd

Factory address: No.9 Zhengfu Road Liangduo Town, Dongtai City Jiangsu Province, P.R. China.
Tel: +86 515 85555809

Shenzhen Office: 446, Huafeng Internet+Creative Garden, No.107 of Gonghe Industrial Road, Xixiang Street, Bao'an District, Shenzhen, China.

Tel: +86 755 23777180

Email: sales@ofled-lighting.com Web: www.ofled-lighting.com www.ofled-lighting.en.alibaba.com



www.ofled-lighting.com

Specifications

Item No.	Watt(W)	Product Size(mm)	Combination scheme	Light Efficiency (lm/W)	Input	Option	CCT (K)	CRI (Ra)
FLMS02-60W	60	340*150*120mm	1*1	115-140	100-240/277Vac or 200-240Vac 50/60Hz	0/1-10V DALI Microwave Sensor PIR sensor Daylight sensor bluetooth Optional	3000-6500	70+
FLMS02-100W	100	340*200*120mm	1*2					
FLMS02-150W	150	340*200*120mm 340*280*120mm	1*2 / 1*3					
FLMS02-200W	200	340*280*120mm	1*3					
FLMS02-240W	240	340*280*120mm 340*370*120mm	1*3 / 1*4					
FLMS02-300W	300	340*370*120mm 340*460*120mm	1*4 / 1*5					
FLMS02-400W	400	640*280*120mm	2*3					
FLMS02-480W	480	640*280*120mm 640*370*120mm	2*3 / 2*4					
FLMS02-600W	600	640*370*120mm 640*460*120mm	2*4 / 2*5					
FLMS02-800W	800	640*550*120mm	2*6					
FLMS02-900W	900	640*550*120mm	2*6					

PF	Beam Angle	LED Type	Driver Brand	Protection Grade	Working Temperature	Storing Temperature
0.95	30° / 90° / 30°x70° / 70°x135° / TYPE-Ⅲ / 120°Flat Lens	3030	MEANWELL OR SOSEN OR ZHI HE OR OTHERS BRAND	IP65	-30℃ ~+50℃	-30℃ ~+80℃

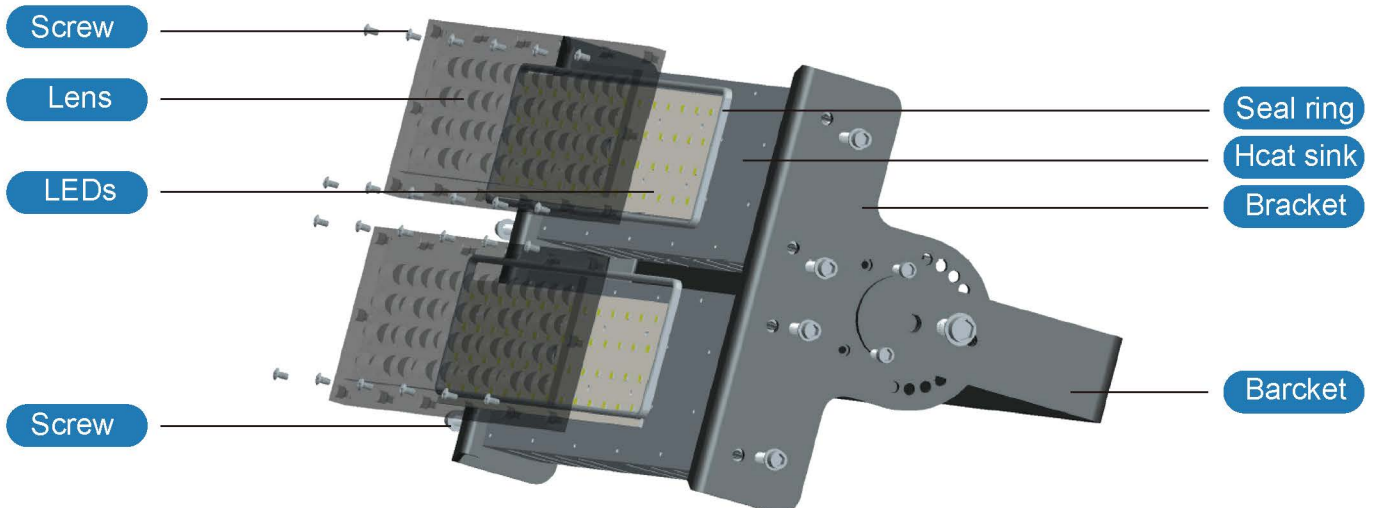

DriverInput Specifications



MEAN WELL

AC100-240V
AC90-305V
50/60Hz



SOSEN

AC90-305V
50/60Hz



ZHI HE

AC100-240V
50/60Hz

Dimension

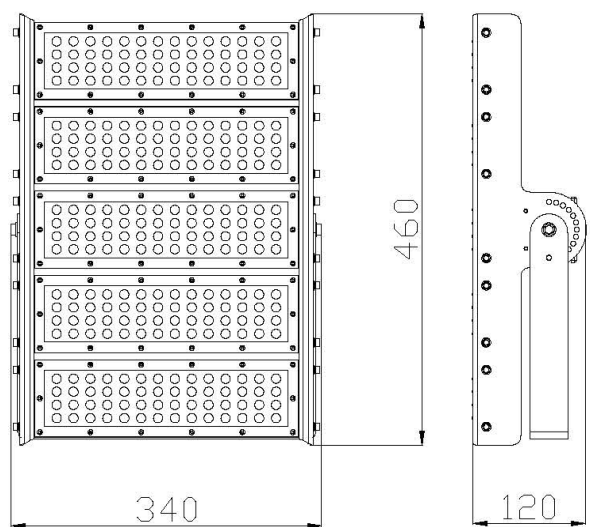
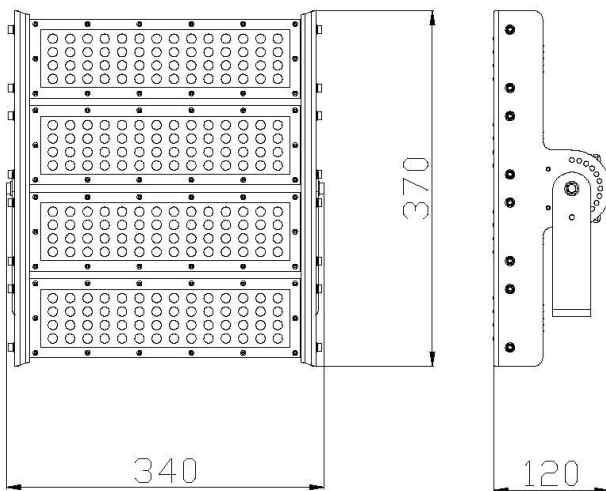
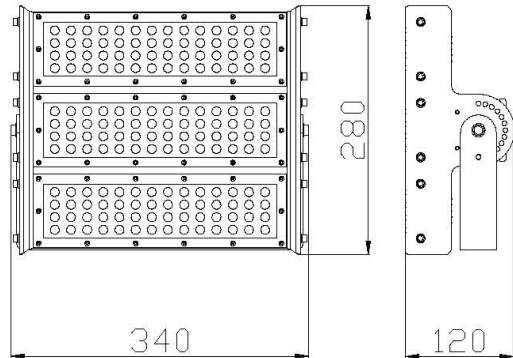
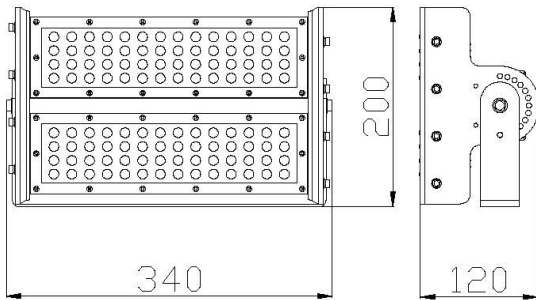

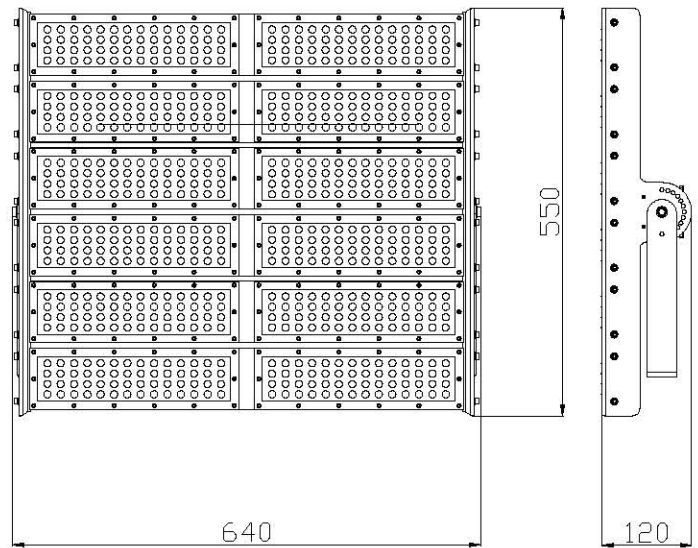
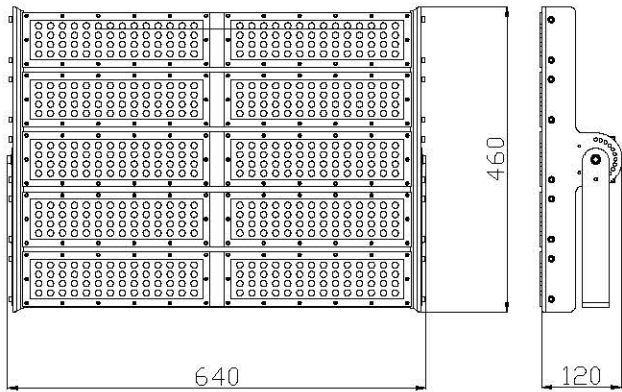
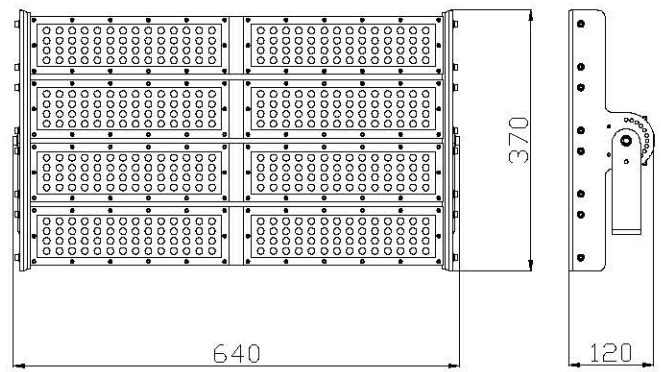
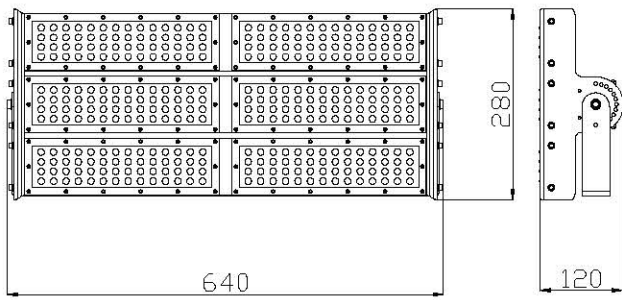

Distribute curve and illuminance distribute curve

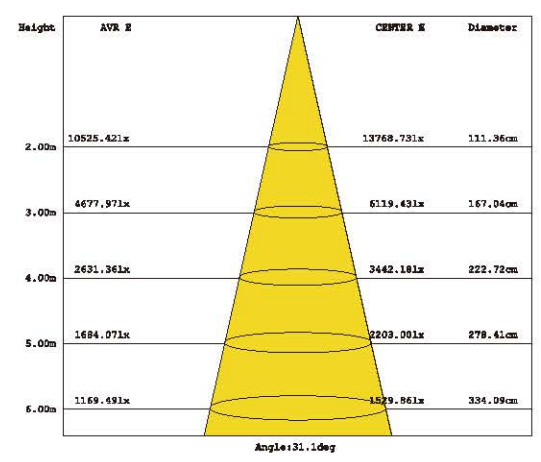
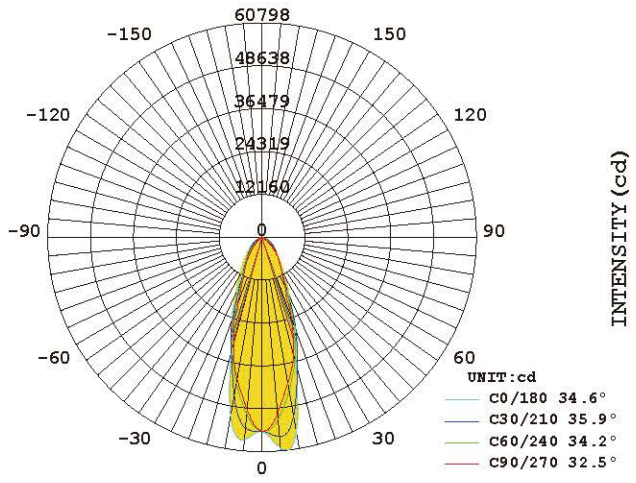

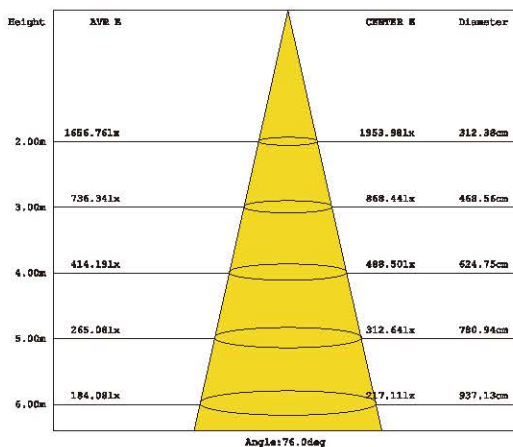
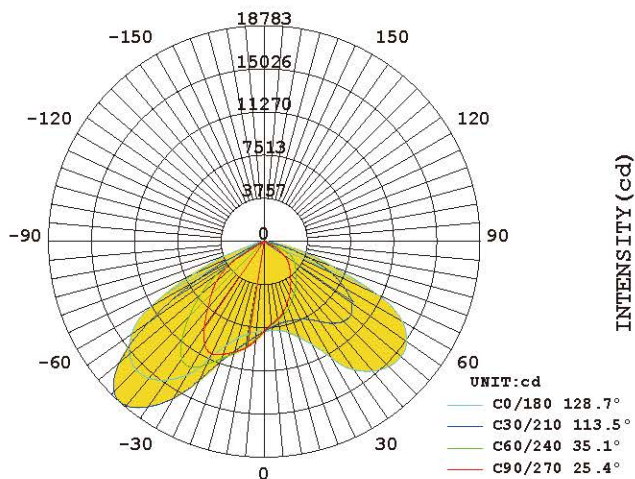
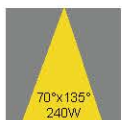
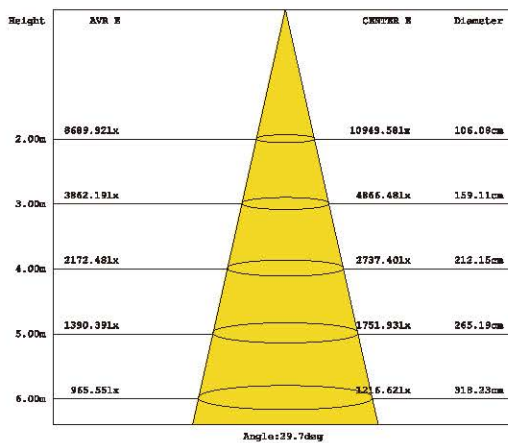
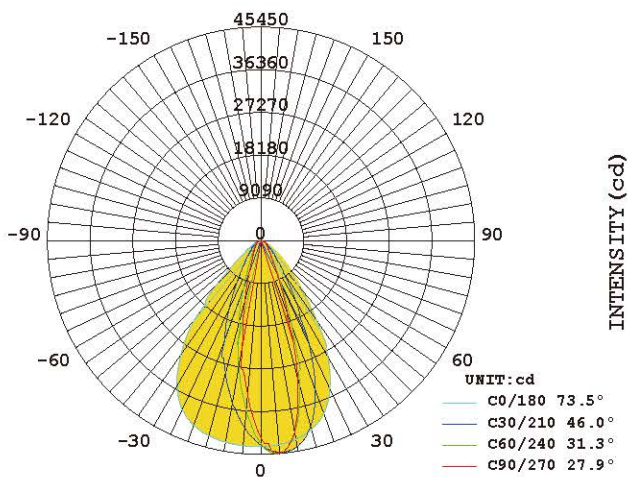
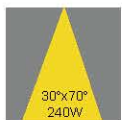
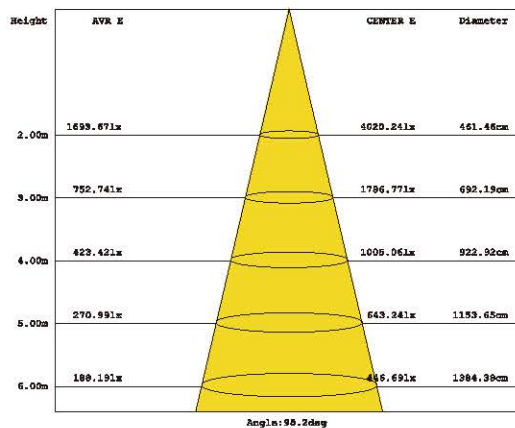
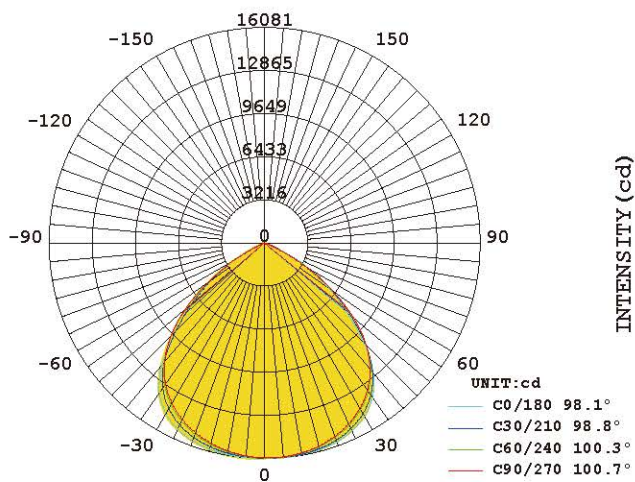
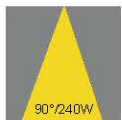

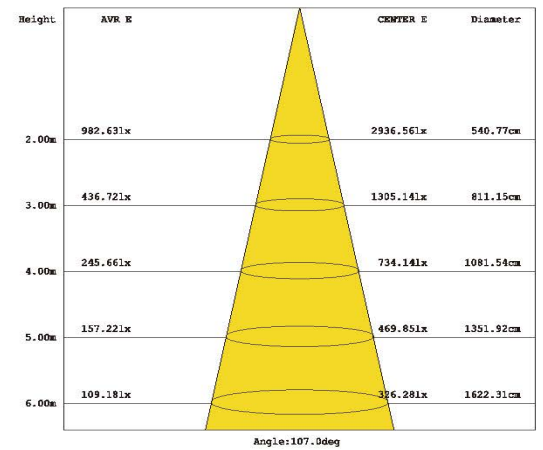
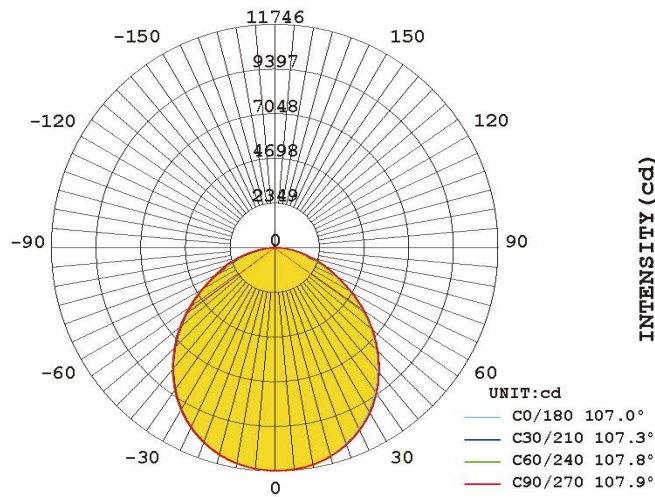
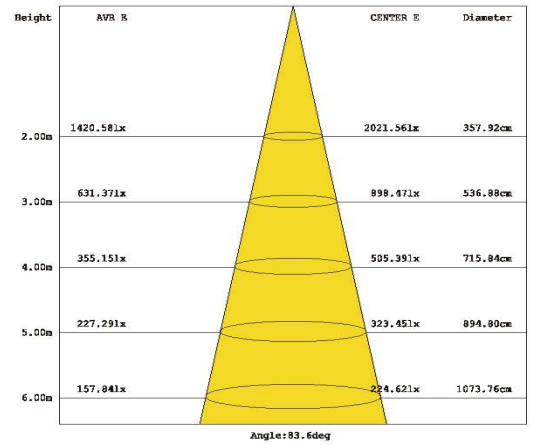
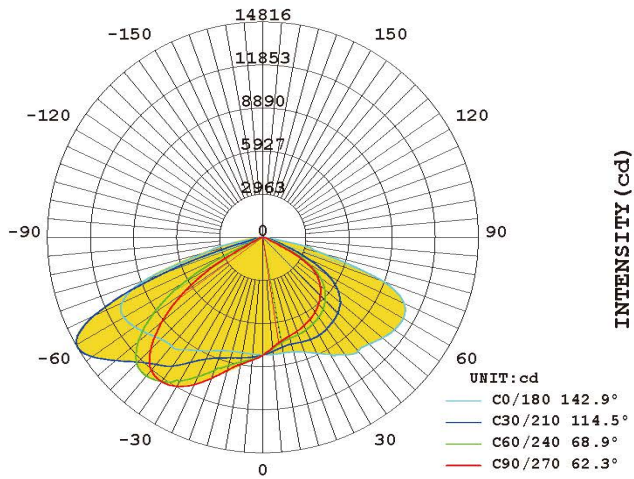
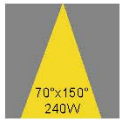

Accessories



OHD-PA-DS01
Daylight sensor



OHD-PFM-LPD
IP65 Lightning
protection device
120~277V 20KA



OHD-PA-WC2
Waterproof connect
+2m cable



OHD-PA-WC5
Waterproof connect
+5m cable



OHD-PA-APW01
Plug+1.5m cable
(driver connect directly)



OHD-PA-APW02
Plug+1.5m cable
+waterproof connect

Installation guide

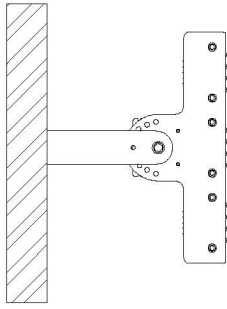

Wall Mounted

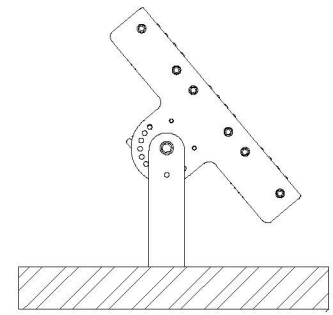
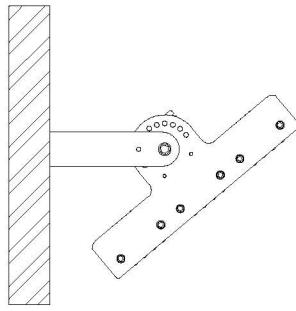

Ground Mounted

Application

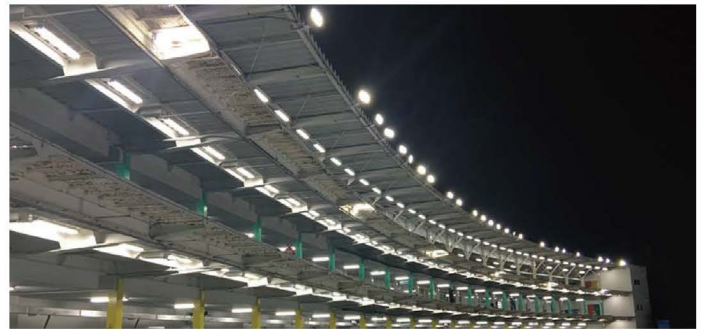

Packaging

Combination scheme	Unit Net Weight	Unit Net Weight	Carton Gross Weight	Carton Size	CBM(m ³)	Product Qty (pcs/20GP) Pallet shipment
1*1	2.7kg	3.3kg	1pcs	L370*W190*160mm	0.012	2250
1*2	4.1kg	4.85kg	1pcs	L370*W240*160mm	0.014	1900
1*3	6.1kg	6.95kg	1pcs	L370*W320*160mm	0.019	1400
1*4	7.3kg	8.2kg	1pcs	L370*W410*160mm	0.024	1100
1*5	9.2kg	10.2kg	1pcs	L500*W370*160mm	0.030	900
2*3	10.9kg	12.1kg	1pcs	L670*W320*160mm	0.034	800
2*4	13.2kg	14.6kg	1pcs	L670*W410*160mm	0.044	600
2*5	16.5kg	17.95kg	1pcs	L670*W500*160mm	0.054	500
2*6	20.6kg	22.1kg	1pcs	L670*W590*160mm	0.064	420

- There will be slight deviation in the actual situation, which is subject to the actual situation.