

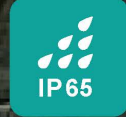

UFO High Bay

Dust-Proof Highbay



www.ofled-lighting.en.alibaba.com

130-150
lm/W

- Light Efficacy: 130-150lm/W
- Option: Non-Dimming,
Dimming (RX/PWM/0/1-10V/DALI)
- Ingress Protection: IP65
- 3 or 5 years warranty



Jiangsu Ofled Optoelectronics Technology Co., Ltd

Factory address: No.9 Zhengfu Road Liangduo Town, Dongtai City Jiangsu Province, P.R. China.
Tel: +86 515 85555809

Shenzhen Office: 446, Huafeng Internet+Creative Garden, No.107 of Gonghe Industrial Road, Xixiang Street, Bao'an District, Shenzhen, China.
Tel: +86 755 23777180

Email: sales@ofled-lighting.com Web: www.ofled-lighting.com www.ofled-lighting.en.alibaba.com



www.ofled-lighting.com

Specifications

| | | |
|------------------------|----------------------------------|---------------|
| Item No. | OHD-UFOG2-150 | OHD-UFOG2-200 |
| Watt(w) | 150W | 200W |
| Product Size | φ418*151mm | |
| Input | 100-240Vac or 100-277Vac 50/60Hz | |
| Light Efficiency(lm/W) | 130-150lm/W | |
| CCT | 3000K/4000K/5000K/5700K/6500K | |
| Beam Angle | 60°/90° | |
| Material | Aluminum | |
| PF | 0.9 | |
| CRI(Ra) | 70+ | |
| Protection Grade | IP65 IK08 | |
| Warranty Years | 3-5 Years | |

Operating Temperature: -30°C ~ +50 °C



Dimension

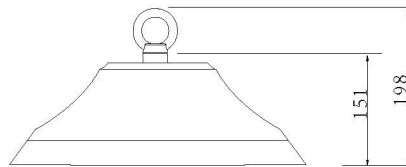
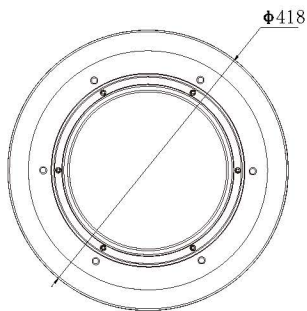

Installation guide

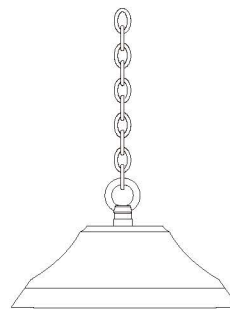

Ring Mounted

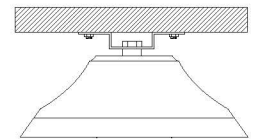

Ceiling Mounted

Light Distribution Optional

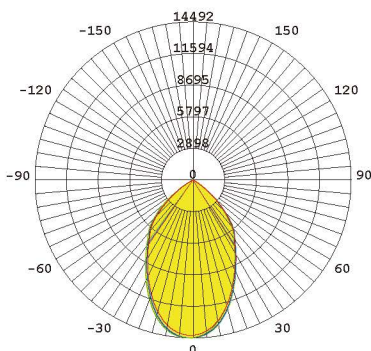

60°

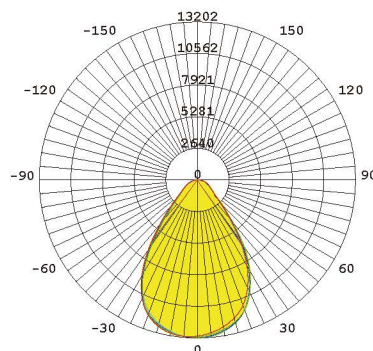

90°

Dust-Proof Highbay

IP65 water-proof



- Products are widely used in food processing plants, pharmaceutical factories, farms, fresh supermarkets and other places that need lighting.