

HIGOLD®

KITCHEN&WARDROBE FUNCTIONAL HARDWARE 2024

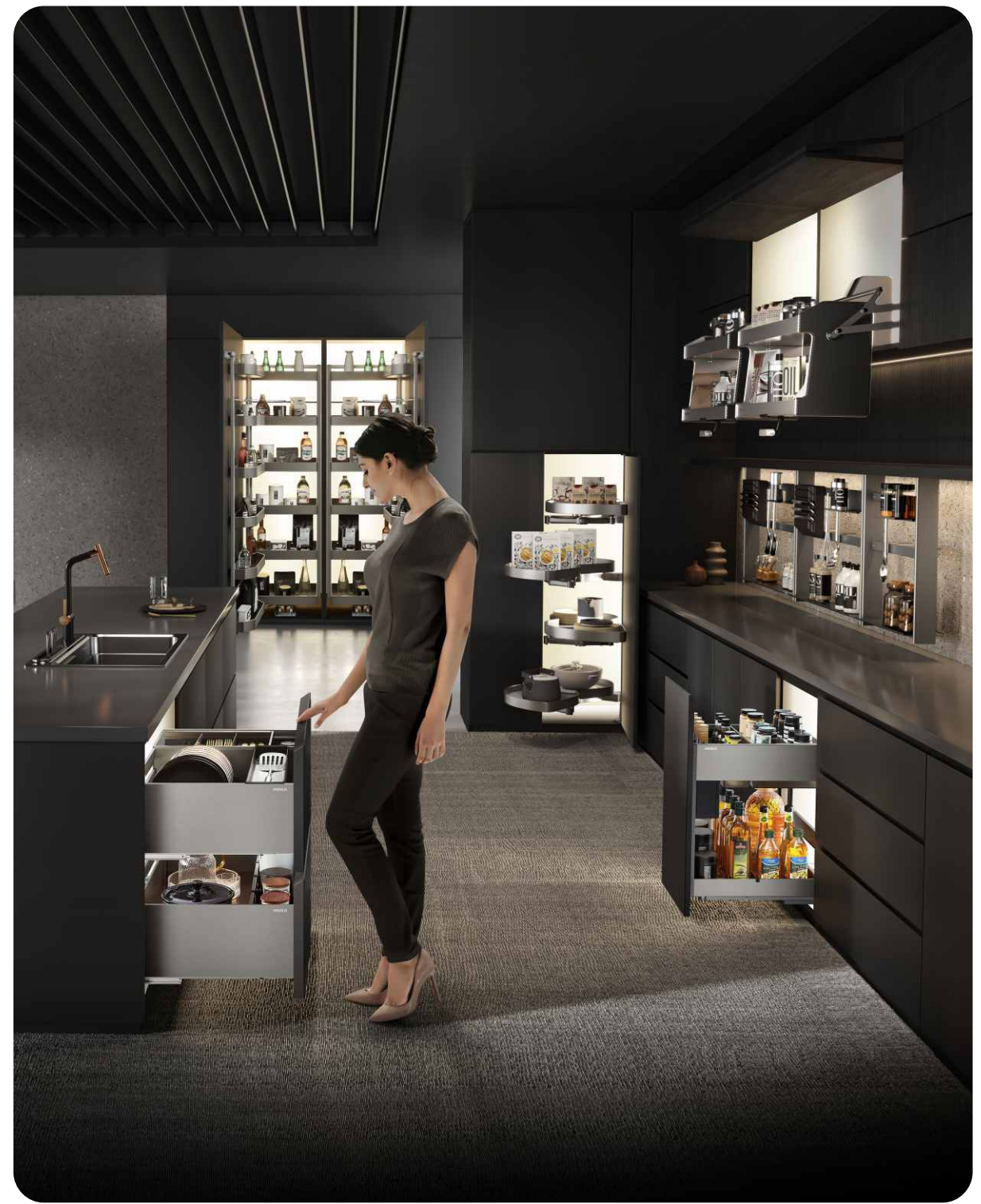

ORIGINAL DESIGN & QUALITY

HIGOLD®

HIGOLD®

HIGOLD GROUP CO.,LTD.

Headquarter Address :
No.36 Shunye east Rd,Xingtan,Shunde,
Foshan 528325,Guangdong,China

T:+86 18128737208
E: Rocky.li@higold.com.cn
W: www.higoldhardware.com



Strive For Improving The Quality Of Human Life



400000^m
PRODUCTION BASE

90⁺
COVERING
COUNTRIES/REGIONS

900⁺
INDEPENDENT
INNOVATION PATENT

8⁺
PRODUCT
CATEGORIES



11 RED DOT
DESIGN AWARDS



12 iF
DESIGN AWARDS

HIGOLD® STAR HEADQUARTER

Focus on High-end Intelligent Manufacturing Diversification Glints the World



HIGOLD® / GROUP

Higold Group Co., Ltd., founded in 2004, is a diversified and innovative enterprise, focusing on home hardware, business including functional hardware, furniture fittings, kitchen and bathroom hardware, cabinet lighting, interior door locks, intelligent kitchen electricity, bathroom cabinet and outdoor furniture. It is committed to creating one-stop high-end hardware solutions for the whole house for global users. As a medium-and high-end brand in China's home hardware industry, its brand awareness and sales scale have always been in a leading position in China. In 2020, Higold signed a contract with Donnie Yen as the brand spokesperson, starting a new journey for the global national brand.

Since its establishment, Higold has always adhered to the strategy of integration of production, research and marketing. It is building manufacturing base of 400,000 square meters, mainly the production base of Higold's Star Headquarter and Higold Hexagonal Building, which is the large-scale intelligent manufacturing base of home hardware in Asia nowadays. With more than 30,000 square meters, Higold Star Headquarters stands in China with a unique architectural design posture in the world. Its avant-garde, high-tech, dynamic and fashionable design elements attracts people's attention.

As a national high-tech enterprise, Higold has a strong engineering technology center and research institute, and long-term strategic cooperation with many top design companies around the world, integrating global high-quality research and innovation resources, providing continuous driving force for "Creative Living · Soul".

Up to now, Higold has more than 900 patents. It is the main drafting unit of the group standard of "Household using kitchen functional hardware—Pull-out basket" and the drafting unit of the national standard of "House Hold Kitchen". Its products have won the Red Dot Design Award, iF Design Award, Red Star Award and other domestic and foreign awards for many times. The group has been awarded "Top 10 Kitchen and Bathroom Accessories Enterprises in China", "Top 10 Hardware Industry in Chinese Household Manufacturing Industry", "Top 100 Foshan Manufacturing Industry in 2021" and many other honors.

Higold products have sold to more than 90 countries and regions in the world, and its sales network covers the whole world. We have hundreds of agents in domestic cities, and we are also the strategic partners of many famous real estate brands and Household brand in China.

Higold is renowned for its excellent quality and innovative design in the industry, and is committed to building a world-renowned household hardware brand and striving to improve the quality of human life.

Founder & President of the HIGOLD GROUP Mr. Alwin Ou



HIGOLD® HEXAGONAL BUILDING

Focus on High-end Intelligent Manufacturing Diversification Glints the World

The second intelligent manufacturing base of Higold Group is Located in Guanghua Industrial Zone, Xingtian Town, Shunde District, with a construction area of 200,000 square metres. Higold Group took the lead in opening a comprehensive digital and intelligent transformation production base of the manufacturing system. The hexagonal building, built to the standard of "dark factory", will create 4 smart factories, one R&D centre and one hardware museum, which will be another success for Higold to build a high-quality smart enterprise.

The first phase of the factory building has been fully constructed into a super factory for automatic production. The main products include hinges, guide rails, drawers and hardware core components. It is currently a demonstration benchmark factory with leading production, quality and efficiency. In the future, it will promote the annual output of hinges to more than 1 billion pieces, and strive to build an unmanned workshop with 24-hour fully automatic production, and strive to become a leading world-class home hardware aircraft carrier.

Strive for improving the quality of human life

HIGOLD · MISSION

Strive to improve the quality of human life

HIGOLD · VISION

Leading world-class home hardware aircraft carrier

HIGOLD · VALUES

Innovation · Challenge and Persistence

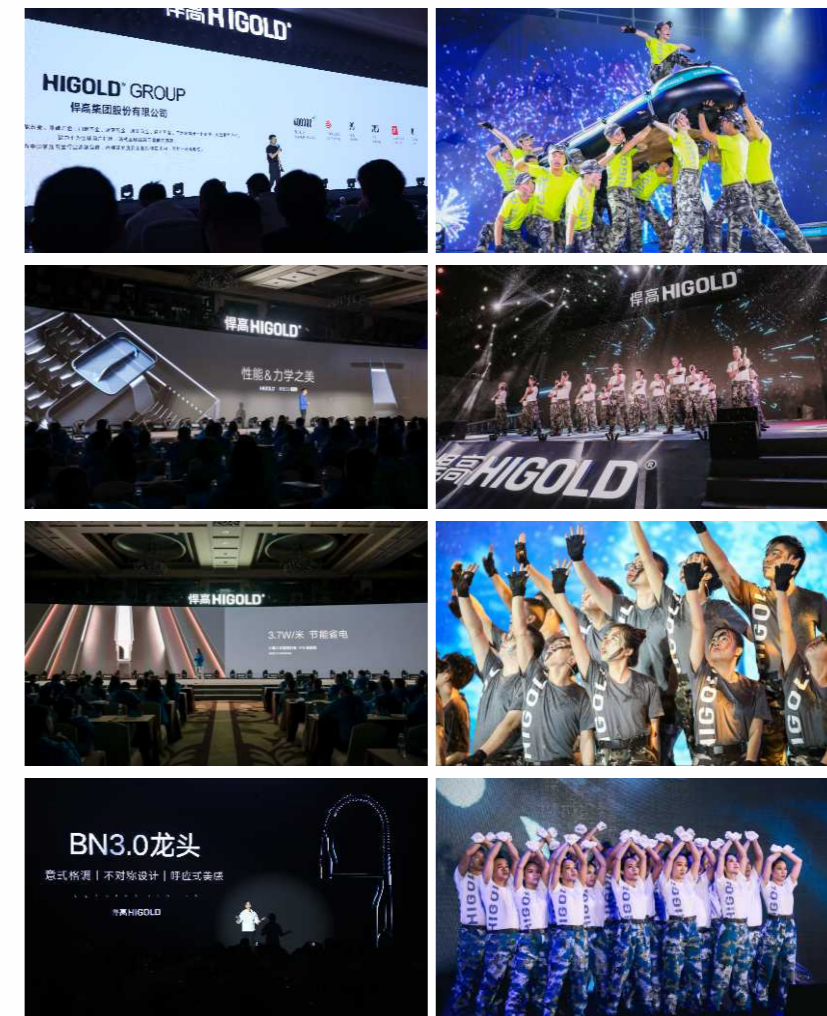

BRAND / HISTORY

HIGOLD®

2004

"Higold" was established to engage in hardware processing and export by renting a 1,500 square meters factory in Nanlang, Xingtian town.

2005

For long-term development, Higold fully designed the brand CI system. The product was positioned as "kitchen functional hardware", mainly for export. In the same year, "Higold Outdoor Furniture Company" was established, and it began to enter the outdoor furniture category and explore diversified development.

2006

The production base was relocated to Xingtian East Village, expanded to 15,000 square meters.

2007

Higold began to enter the Chinese market; functional hardware products such as corner and tall cabinet units were successfully developed and put into production; and began to cooperate with several well-known domestic cabinet industry customers.

2008

Survived after the Asian financial crisis, Higold was determined to focus on domestic sales, supplemented by exports, and focus on design and branding as the core of development.

2011

Became the Top 10 kitchen and bathroom accessories enterprise in China.

2012

Awarded Shunde Longteng Enterprise; Higold production base was expanded to 40,000 square meters; products were sold to 56 countries and regions around the world. The outdoor furniture company participated in the SPOGA exhibition in Cologne, Germany, with a booth of 150 square meters; Higold furniture showed its original design to the world with its own brand.

2013

Higold Kitchenware Company was established, and the product line was extended to kitchen hardware such as sinks and faucets.

2014

Higold was awarded The Red Dot Award with its original design "Space Capsule" Outdoor Furniture. The opening of flagship store of outdoor furniture with an area of 1000 in Amsterdam, Netherlands. Higold E-Commerce Company was established, and products were sold on e-commerce platforms such as Tmall and JD.com.

2015

Higold brand experience pavilions were set up in 70 cities in China; Hardware and furniture products were sold to 86 countries worldwide. The second production base for functional household hardware was put into operation. Awarded National High-tech Enterprise. Higold was selected as the drafting unit of the national standard of "Household Kitchen Equipment".

2016

Advertisements of Higold were displayed in Times Square, New York, USA. Higold was assigned to be the "Executive President Unit" of China National Hardware Association; Higold Hardware, which set up agencies over 100 cities in China, indirectly sells products to customers through over 10k special kitchen cabinet stores.

2017

The third production base was built in Shunde High-Tech Zone, and the plant was expanded by 200,000m²; With first-class original design, Higold Outdoor Furniture Company has continuously opened brand stores in Netherlands, Italy, Dubai, the United States, Australia, Malaysia, etc., and enjoyed a worldwide reputation. Pininfarina and Higold reached a long-term strategic cooperation, injecting a constant internal drive for Higold's originality. Higold Smart Kitchen was awarded the 2017 Red Dot Design Award, which was the second time that Higold won this prize. Higold won the invention patent of Mini outdoor Mobile Toaster Oven and was sold around the globe through Metro and Walmart. Higold was selected as the main drafting unit of the group standard of "Functional Hardware Basket for Home Use".

2018

Higold's Star Headquarters is the first original designed building in China by the Italian Ferrari design partner Pininfarina team which attract people's attention. The new headquarters are going to be Higold's product innovation R&D centre and new business model operation centre. Higold's outdoor furniture series were gradually expanded to outdoor ovens and outdoor umbrellas; Higold's original design, mobile toaster oven, was awarded the 2018 Red Dot Design Award, which marked the third time of Higold's winning of this prize.

2019

The Chairman of Higold Group, Mr. Alwin Ou, was awarded the title of Advanced Entrepreneur of the New Era" by the government; he was selected as a honorary winner in the "China Home Furnishing Industry Hall of Fame" by China National Furniture Association. Higold's intelligent purification sink, which can solve food safety problems, has been featured in CCTV's programme "Consumer Advocate".

2020

Awarded Manufacturing Single Champion Enterprise in Foshan High-tech Zone; Signed international superstar Donnie Yen as the brand spokesman, starting the journey of strong cooperation. Higold Group's brand strategy development reached a new height. 2020 IF design award: Higold outdoor furniture ONDA series.

2021

Awarded the Certificate of The National Quality Inspection: Stable and Qualified Products issued by China Association for Quality Inspection; The rooftop sealing of Higold Group's Star Headquarters was successfully carried out; Higold's intelligent manufacturing base of home hardware laid the foundation stone, focusing on building a group of digital production site of 340,000 . 2021 Red Dot Design Award and iF Design Award: Higold's Shearer Hardware Collection. 2021 iF Design Award: Higold BN Faucet 1.0 Higold Shearer 3.0 obtained the Chinese invention patent, successfully breaking the technology monopoly of European companies in same type of products.

2022

Higold Group redefines its goal: to become a world-renowned home hardware brand. Our product line has gradually developed from local hardware to whole-house hardware, including functional hardware, basic hardware, kitchen and bathroom hardware, cabinet lighting, internal door locks, smart kitchen appliances, bathroom cabinets, outdoor furniture in one of the diversified innovative enterprises, committed to creating one-stop whole-house and high-end hardware solutions for global users. The Higold Star Headquarter has been completed and put into use, and has become a favorite place for designers to check in. Higold's intelligent manufacturing base of home hardware-No.1 Factory was topped out. The total construction area is over 180,000 , which is an industry-leading factory. Higold Multi-functional Purification Kitchen Sink won the Chinese invention patent. 2022 Red Dot Design Award: Higold Multifunctional Purification Kitchen Sink. 2022 Red Dot Design Award: Higold BN Faucet 2.0. 2022 iF Design Award: Higold P10 integrated sink dishwasher. 2022 iF Design Award: Higold BN Faucet 2.0. 2022 iF Design Award: Higold Multifunctional Purification Kitchen Sink. Higold won the "FT Quality Award" in 2021. CCTV "Live Greater Bay Area" columns enter into Higold, focusing on the rapid development of Chinese hardware.

2023

2023 German Red Dot Design Award: Higold Inner Door Lock F1 Series; 2023 German Red Dot Design Award: Higold Inner Door Lock F2 Series; 2023 iF Design Award: Higold Tourbillon Rotating Basket; 2023 iF Design Award: Higold BL2.0 Multifunction Sink; 2023 iF Design Award: Higold Built-In Range Hood. Higold won the industry unique brand "Iconic brand of China's Home Hardware industry". Higold won two "2022 FT Quality Gold Awards". Higold won four "2023 FT Quality Awards". Higold won the "2022 Craftsman Spirit Award". Higold won four "2023 Himalaya Design Awards". Higold Group has reached strategic cooperation with Oppein, Kefan, Gabor, and other household brands.

2024

2024 iF Design Award: Higold BL3.0 series; 2024 iF Design Award: Higold Armonia series; 2024 iF Design Award: Higold LEVIA series. 2024 Red Dot Design Award: Higold Shearer 3.0 Pro series; 2024 Red Dot Design Award: Higold B2 series; 2024 Red Dot Design Award: Higold TEKNO R series.

DESIGN / POWER

HIGOLD®

Designers from Germany, Italy, the United States, France, Australia, Asia and other countries to form a joint design team, these are Higold original aesthetics of the source power.



 **The winner of 2014 Red Dot Award**
Higold SHENZHOU-10 space capsule

 **The winner of 2017 Red Dot Award**
Higold Water Dispens

 **The winner of 2018 Red Dot Award**
Higold kitchen intelligent mini oven

 **The winner of 2021 Red Dot Award**
Higold Shearer 4.0 series

 **The winner of 2022 Red Dot Award**
Higold's Piniz Faucet 2.0

 **The winner of 2022 Red Dot Award**
Higold Multifunctional Purification Kitchen Sink

 **The winner of 2023 Red Dot Award**
Higold Inner Door Lock F1 Series

 **The winner of 2023 Red Dot Award**
Higold Inner Door Lock F2 Series

 **The winner of 2024 Red Dot Award**
Higold Shearer 3.0 Pro Series

 **The winner of 2024 Red Dot Award**
Higold B2 Series

 **The winner of 2024 Red Dot Award**
Higold TEKNO R Series

 2020 iF Design Award:
"ONDA" Series from HIGOLD Outdoor furniture

 2021 iF Design Award: Higold Shearer 4.0 Series

 2021 iF Design Award: Higold Piniz faucet

 2022 iF Design Award: Higold's Piniz faucet 2.0

 2022 iF Design Award:
Higold Multifunctional Purification Kitchen Sink

 2022 iF Design Award: Higold P10 integrated sink dishwasher

 2023 iF Design Award: Higold Built-In Range Hood

 2023 iF Design Award: Higold BL2.0 Multifunction Sink

 2023 iF Design Award: Higold Tourbillon Rotating Basket

 2024 iF Design Award: Higold BL3.0 Sink

 2024 iF Design Award: Armonia series

 2024 iF Design Award: Higold LEVIA series

National high-tech enterprises

ISO14001 environmental management system certification

ISO9001 quality management system certification

Iconic brand of hardware Industry

Provincial industrial design center

Provincial Specialized and New Enterprise

Provincial Top 100 e-commerce Enterprise

Selected into the China Household Hall of Fame Enterprise

The top 10 of hardware Industry

Top 500 of China Household Manufacturing Industry

The top 100 Manufacturing Enterprises in Foshan City

 National Standards Maker of Kitchen Hardware Industry

 Functional hardware drawing basket master drafting unit

 National High-Tech Enterprise

 Top ten Chinese enterprises of kitchen and bathroom accessories



Red Star Design Award



Red Star Design Award



kapok
Design Award China



FT Quality Award



Canton Fair Design Award



Canton Fair Design Award



Canton Fair Design Award



HIMALAYA Design Awards



HIMALAYA Design Awards



HIMALAYA Design Awards



The Pinnacle
Awards Asia-pacific



Pininfarina
Co-designing institute



Gloden Hook Prize

MENU

GROUP INTRODUCTION 003

SHEARER SERIES 017

TOURBILLON PANTRY	019
TALL UNIT	025
LIFT BASKET	041
SWING TRAYS 3.0	053
MAGIC CORNER	057
SHEARER 4.0	065
SHEARER 4.0 PRO	073
GHIDORAH BASE UNITS	081
L SERIES	089
SHEARER 3.0	097
SHEARER 3.0 mini	103
SHEARER 6.0 mini	113
JING RAN	121
SHEARER THREE SIDES	139
SHEARER FOUR SIDES	141
GRAIN BASKETS	143
CAPRI MID WAY SET	149

DIAMOND SERIES 151

TALL UNIT	153
DISH AND BOWL LIET BASKET	165
SWING TRAYS 3.0	167
MAGIC CORNER	171
STARRY BASE UNITS	179
SIDE BASKET	185

FASHION SERIES 189

TALL UNIT	191
SS Draining Rack	195
FOUR SIDE BASKET	197
MAGIC CORNER	199
NARROW BASKET	201
CLEAR-LIQUID RACK	205

PLATINUM SERIES 207

PLATINUM 2.0 BASE UNITS	209
STARLINK 2.0 BASE UNITS	215
MARTIN 2.0 BASE UNITS	223
M SERIES BASE UNITS	231

WASTEBIN 235

WARDROBE ACCESSORIES 245

B SERIES	249
B 2.0 SERIES	289
A SERIES	309
MUSE SERIES	323

FUNCTIONAL HARDWARE

HIGOLD®

Leading Design
Perfect Experience



KITCHEN

Stylish design and innovative details, combined with large-capacity storage and functional practicability, are a new interpretation of the Higold kitchen storage hardware system. The smooth and smooth opening and closing action makes storage more convenient; the quality from the inside to the outside is strictly controlled to achieve durability. Precision craftsmanship only creates high-quality, cleaner kitchens for users.

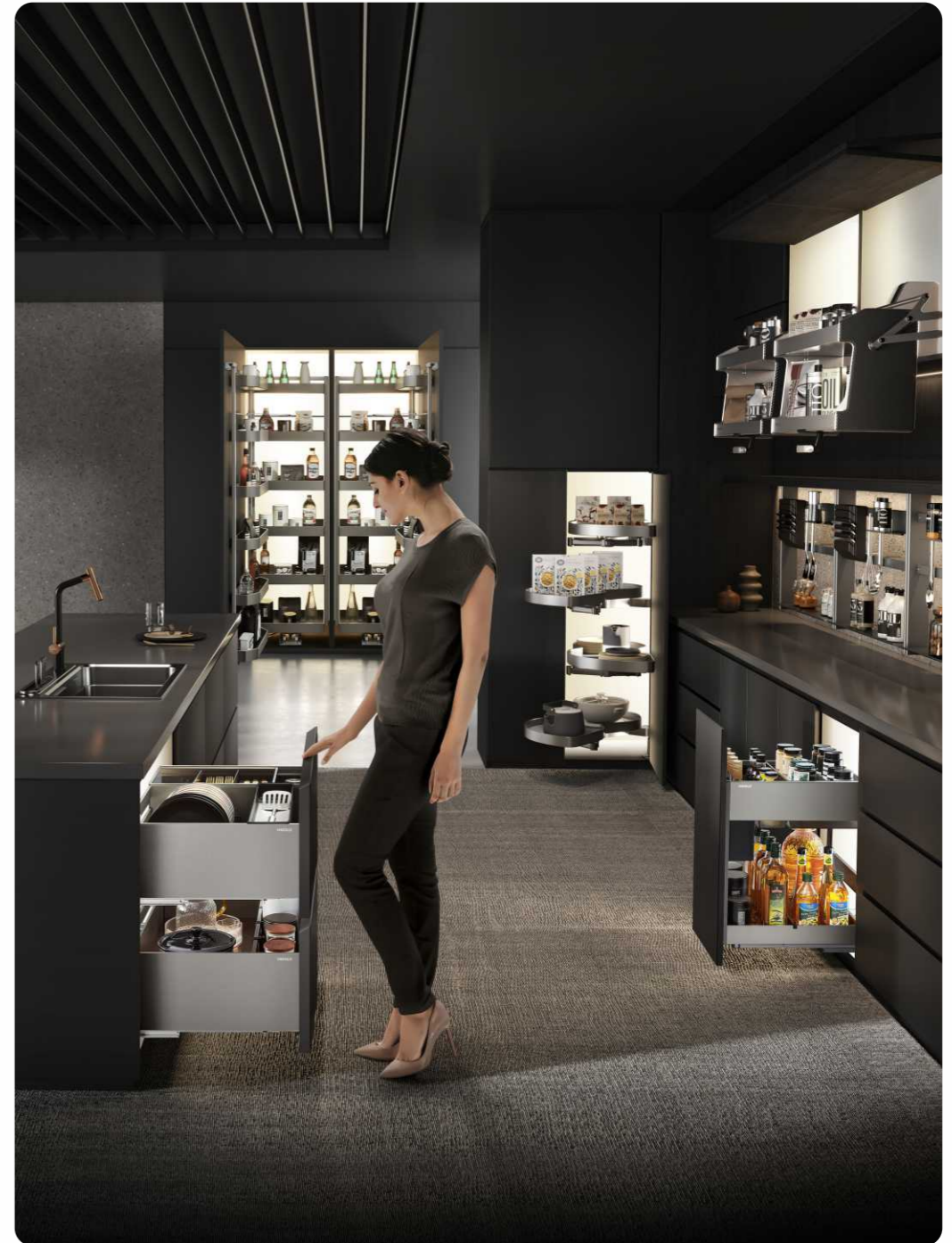

SHEARER SERIES

Artistic, Elegant, Exquisite.



TOURBILLON PANTRY

“ 360°rotating ”
creating a comfort zone

Unique design, born extraordinary

HIGOLD®





TOURBILLON PANTRY

A Mechanical Piece Of Art
Mega Storage Space

HIGOLD®



SHEARER / SERIES

TOURBILLON PANTRY

Patent NO. : ZL202122510746.5
 Patent NO. : ZL202230189307.6

Patented design on the serial movement with a dual structure and rotatable trays, smooth rotation and bold appearance, simple but remarkable. Quick access by swivelling the cabinet door, save time and effort. Tourbillon pantry represents a revolutionary way of experiencing the rotatable pantry, providing users with more convenient and comfortable cabinet storage solutions.



1. Open the cabinet door, bring the whole wall to your eyes.



2. If you want to get something inside the basket, turn the tray gently.



3. The tray can rotate 360°, and the way of fetching is easier.



4. After letting go, the basket body automatically returns to normal.

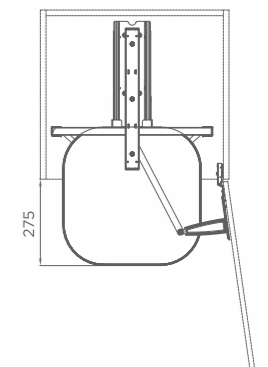
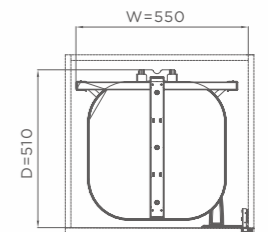

ART. NO	CABINET	W x D x H	MATERIAL	SURFACE	REMARK
202294	600mm	550x510x(1375-1675)mm	Steel+Aluminum	Nano-coating	4 layers
202295	600mm	550x510x(1675-1975)mm	Steel+Aluminum	Nano-coating	5 layers
202296	600mm	550x510x(1975-2275)mm	Steel+Aluminum	Nano-coating	6 layers

SHEARER STORAGE DRAWER

*Independent storage
multi-layer pull-out*

HIGOLD®



STORAGE DRAWER / SHEARER SERIES

Patent NO. : CN202430120402X
 Patent NO. : CN2024301204015
 Patent NO. : CN2024301204000

NAME	ART. NO	CABINET	W x D x H	MATERIAL	REMARK
Storage & Wine Glass	303802	600mm	564x480x110 mm	Aluminum	Soft close
Wine Storage Pull Out	303803	600mm	564x480x110 mm	Aluminum	Soft close
Storage Pull Out C	303804	600mm	564x480x90 mm	Aluminum	Soft close
Storage Pull Out B	303805	600mm	564x480x90 mm	Aluminum	Soft close
Storage Pull Out A	303801	600mm	564x480x90 mm	Aluminum	Soft close

SHEARER SPACE PANTRY

Bring you the extraordinary elegant enjoyment
with the gesture of inspiring home appliance

HIGOLD

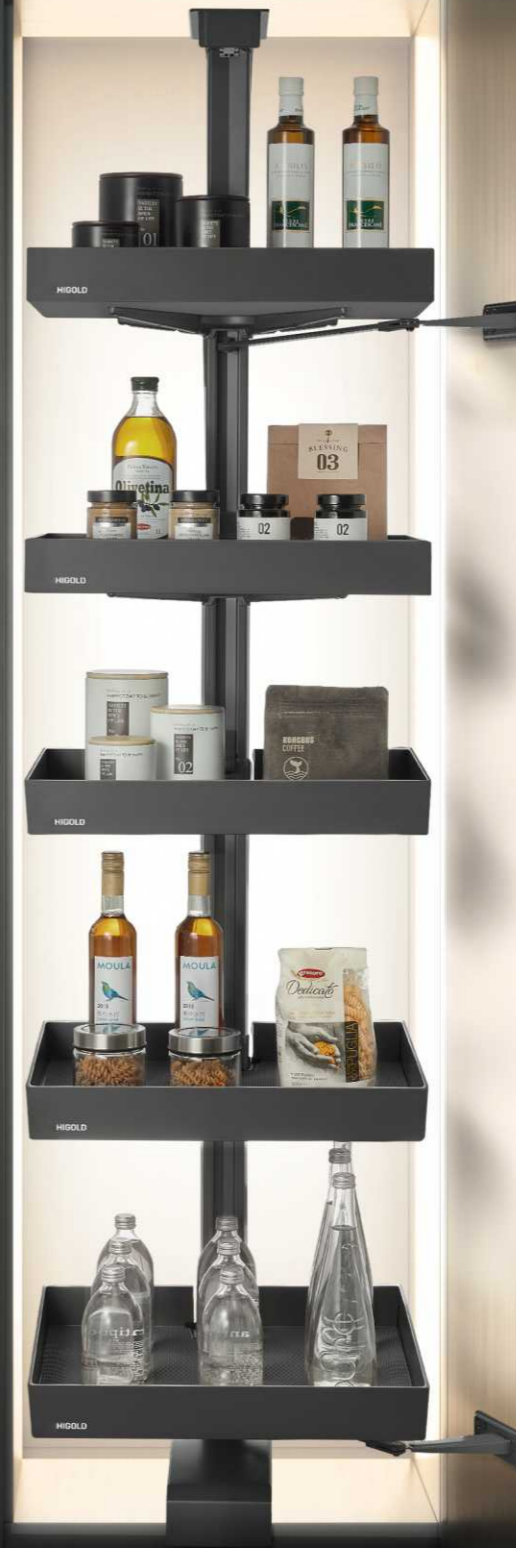



SHEARER / SERIES

SPACE PANTRY

Patent NO. : ZL201420232580.2
 Patent NO. : ZL201511009012.1
 Patent NO. : ZL201430122180.1

Use the principle of space structure to build multi-layer adjustable storage, giving excellent storage performance. Not only is it equipped with door body linkage opening and closing to improve the convenience of storage, but also equipped with silent heavy-duty slide rails, the opening and closing are smooth and smooth, comfortable and quiet!

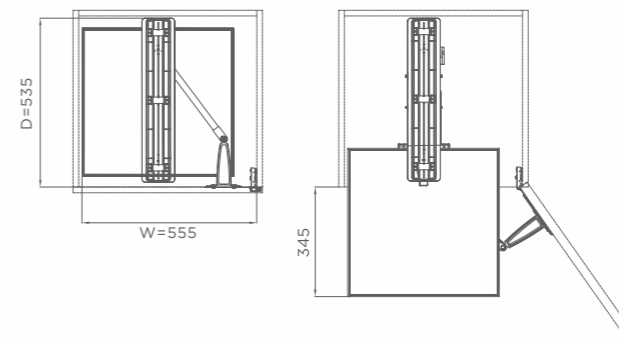

ART.NO	CABINET	W x D x H	MATERIAL	SURFACE	REMARK
205182	500mm	455x535x(1720-2020)mm	Steel+Aluminum	Nano-coating	5 layers
205183	500mm	455x535x(2020-2320)mm	Steel+Aluminum	Nano-coating	6 layers
205185	600mm	555x535x(1720-2020)mm	Steel+Aluminum	Nano-coating	5 layers
205186	600mm	555x535x(2020-2320)mm	Steel+Aluminum	Nano-coating	6 layers

SHEARER TALL LARDER UNITS

Storage aesthetics, fashionable style

HIGOLD®





SHEARER / SERIES

TALL LARDER UNITS

Patent NO. : ZL201830253630.9
Patent NO. : Z7201922047348.7

The Shearer Tandem Pullout Pantry, utilizes the narrow kitchen storage space efficiently, makes it more convenient for storage. Stylish matt grey nano-coated surface, offering pleasing and comfortable kitchen experience.

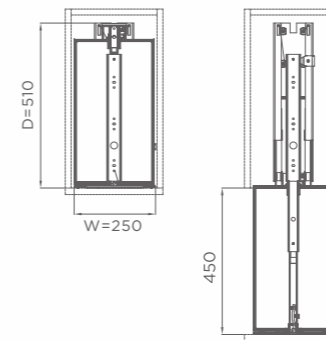

ART. NO	CABINET	W x D x H	MATERIAL	SURFACE	REMARK
201181	300mm	250x510x(1259-1659)mm	Steel+Aluminum	Nano-coating	4 layers
201182	300mm	250x510x(1659-2059)mm	Steel+Aluminum	Nano-coating	5 layers
201183	300mm	250x510x(1959-2359)mm	Steel+Aluminum	Nano-coating	6 layers
201184	400mm	350x510x(1259-1659)mm	Steel+Aluminum	Nano-coating	4 layers
201185	400mm	350x510x(1659-2059)mm	Steel+Aluminum	Nano-coating	5 layers
201186	400mm	350x510x(1959-2359)mm	Steel+Aluminum	Nano-coating	6 layers

HIGOLD®

SHEARER SWIVEL PULL OUT

Artistic, Elegant, Exquisite.
Leading Design, Perfect Experience.





SHEARER / SERIES

SHEARER SWIVEL PULL OUT

Patent NO.: ZL201920460643.2
Patent NO.: ZL202220774037.X

With mega storage space, the Shearer Swivel Pullout Pantry offers flexible partitions for all kinds of stuffs, easily pull out the basket with swivelling door, easy and effortless access to every layer under the great performance of the heavy-duty slide. Smooth movement and strong bearing capacity.

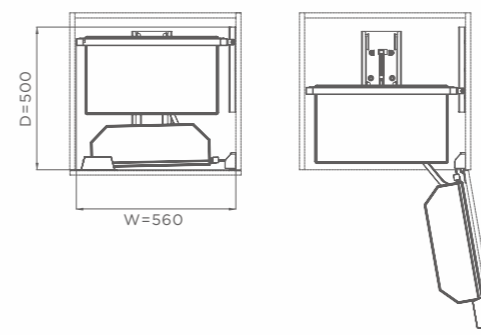

ART. NO	CABINET	W x D x H	MATERIAL	SURFACE	REMARK
202251	450-500mm	410x500x1325mm	Steel+Aluminum	Nano-coating	4 layers
202252	450-500mm	410x500x1625mm	Steel+Aluminum	Nano-coating	5 layers
202253	450-500mm	410x500x1825mm	Steel+Aluminum	Nano-coating	6 layers
202254	600mm	560x500x1325mm	Steel+Aluminum	Nano-coating	4 layers
202255	600mm	560x500x1625mm	Steel+Aluminum	Nano-coating	5 layers
202256	600mm	560x500x1825mm	Steel+Aluminum	Nano-coating	6 layers

NEBULA LIFT BASKET

Light lift and easy access

HIGOLD®





SHEARER / SERIES

NEBULA LIFT BASKET

Patent NO. : ZL202230189304.2

The Higold Nebula Lift has comprehensively innovated the Galaxy Mechanical Lifting System, two-way lifting buffer damping design, combined with personalized 3-gear adjustment buttons, to provide consumers with a more comfortable solution for storage and retrieval of wall cabinets, bringing consumers more joy of kitchen lift, giving consumers a higher quality of kitchen life experience. Nebula Lift integrates with 3-gear speed boost adjuster, allowing consumers to adjust rebound strength and balance according to the weight of the item placed, giving a cloud-like push and pull experience.

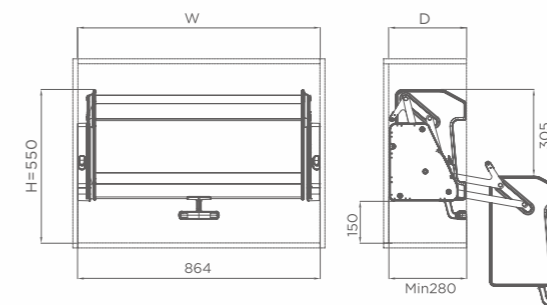

ART. NO	CABINET	W x D x H	MATERIAL	SURFACE
401281	600mm	564x280x550mm	Steel+Aluminum	Nano-coating
401282	700mm	664x280x550mm	Steel+Aluminum	Nano-coating
401283	800mm	764x280x550mm	Steel+Aluminum	Nano-coating
401284	900mm	864x280x550mm	Steel+Aluminum	Nano-coating

SHEARER LIFT BASKET

Lift and lower freely Within reach

HIGOLD®





SHEARER / SERIES

SHEARER LIFT BASKET

Patent NO. : ZL201830253637.0

It can be lifted up and down freely and within reach. With the mechanical load-bearing system, it is flexible and convenient to fetch objects from a height. The buffer damping function enables stable push and pull. Adjustable gravity gears shape a more user-friendly detail. Push and pull take less effort when adjusting the strength according to the weight of item.

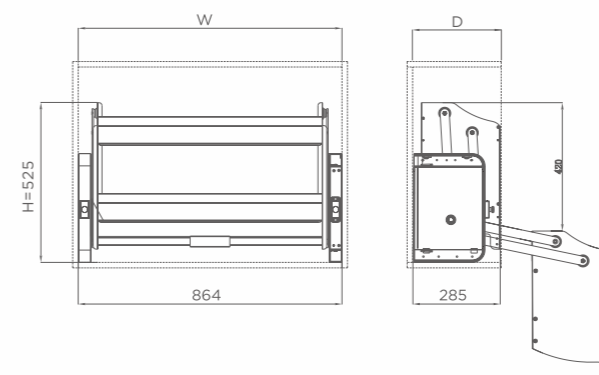

ART. NO	CABINET	W x D x H	MATERIAL	SURFACE
401221	600mm	564x285x525mm	Steel+Aluminum	Nano-coating
401222	700mm	664x285x525mm	Steel+Aluminum	Nano-coating
401223	800mm	764x285x525mm	Steel+Aluminum	Nano-coating
401224	900mm	864x285x525mm	Steel+Aluminum	Nano-coating



STAR MOVE ELECTRICAL LIFT BASKET

Sensor Touch Control, Smooth Movement

HIGOLD®



SHEARER / SERIES

STAR MOVE ELECTRICAL LIFT BASKET

The real magic is the effortless storage of wall cabinets. Touch control lifting, no manual pushing and pulling required, wall cabinet space can also be stored frequently. The aluminum material is thick and double-layered with a total load-bearing capacity of 15KG. No matter how heavy the object is, it can be safely placed.



ART. NO	CABINET	W x D x H	MATERIAL	SURFACE	REMARK
401301	600mm	570x190x690mm	Aluminum	Nano-coating	110-240V/50HZ
401302	700mm	670x190x690mm	Aluminum	Nano-coating	110-240V/50HZ
401303	800mm	770x190x690mm	Aluminum	Nano-coating	110-240V/50HZ
401304	900mm	870x190x690mm	Aluminum	Nano-coating	110-240V/50HZ

SHEARER SWING TRAY 3.0

Streamlined & light

Improve life with design inspiration

HIGOLD





SHEARER / SERIES

SWING TRAYS 3.0

Patent NO.: ZL202010424189.2
Patent NO.: ZL202130385109.2

Higold Swing Tray 3.0 - Shearer Style realizes a new pull-out motion trajectory of rotary cut-in through precise mechanical design of two axes and points. In the exquisite motion trajectory, it realizes the balanced fusion of aesthetics, function and interaction, greatly improving corner storage experience and satisfying the diverse needs for personalized storage of consumers.

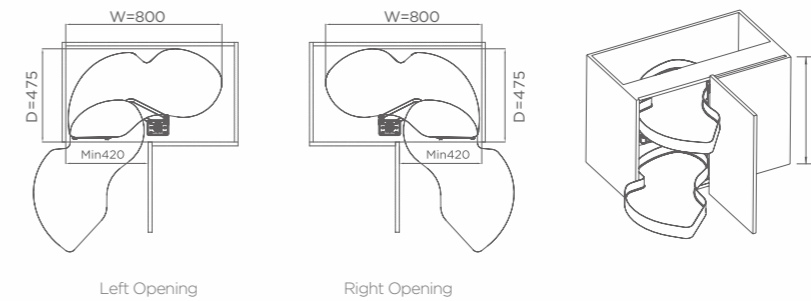

ART. NO	CABINET	W x D x H	MATERIAL	SURFACE	REMARK
101081	≥900mm	800x475x(600-750)mm	Steel+Aluminum	Nano-coating	2 layers/ left opening
101082	≥900mm	800x475x(600-750)mm	Steel+Aluminum	Nano-coating	2 layers/ right opening

SHEARER MAGIC CORNER

Extraordinary corner
storage experience

HIGOLD®





SHEARER / SERIES

SHEARER MAGIC CORNER

Patent NO.: ZL202122637437.4
Patent NO.: ZL202122637501.9

It utilizes the corner space of kitchen to realize "no dead corner storage", reducing squatting and facilitating use.
High-performance damping slides, trouble-free open and close, quiet and smooth.
Stable product structure with steady push and pull, durable service life and worry-free quality.

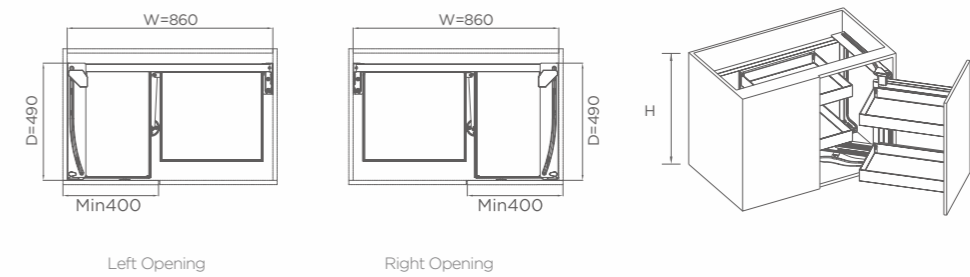

ART. NO	CABINET	W x D x H	MATERIAL	SURFACE	REMARK
101055	≥900mm	860x490x535mm	Steel+Aluminum	Nano-coating	left opening
101056	≥900mm	860x490x535mm	Steel+Aluminum	Nano-coating	right opening



SHOW HAND
MAGIC
CORNER

*Light and flexible
diverse kitchen storage*

HIGOLD®



SHEARER / SERIES

SHOW HAND MAGIC CORNER

Shearer show hand corner use the split design so that all the baskets can be pulled quietly. Re-enter the deep cabinet hardware is also instantly visible, palpable, to create elegant, easy and convenient kitchen life experience.

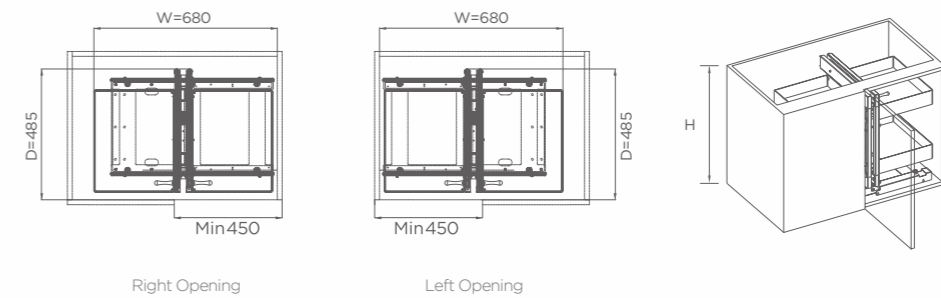

ART. NO	CABINET	W x D x H	MATERIAL	SURFACE	REMARK
101148	≥800mm	680x485x590mm	Steel+Aluminum	Nano-coating	left/right opening



SHEARER 4.0 / SERIES

SHEARER 4.0 BASE UNITS



Patent NO. : ZL202130850255.8
Patent NO. : ZL202030057021.3
Patent NO. : ZL202020963650.7
Patent NO. : ZL202122547978.8
Patent NO. : ZL202130857647.7
Patent NO. : ZL202130163682.9
Patent NO. : ZL202130850264.7
Patent NO. : ZL202030057005.4
Patent NO. : ZL202020957731.6
Patent NO. : ZL202122547978.8

Through upgrading and optimizing product material, product structure, aesthetic design and so on, reshaping space and upgrading storage. The storage space and storage layout of products are greatly improved through the multi-layer storage structure with pumping and the flexible adjustable dividers. It not only meets the daily storage, but also takes into account the differences in living habits between the north and the south. The multi-functional storage area is designed to strengthen the storage space for special-shaped items and meet the storage needs of users in different regions. Space aluminum alloy basket body, make the product more light, strong, scratch resistant and easy to clean, ensure durable. The guide rail of high quality steel has not only passed the European standard GS50000 motion test, but also equipped with dense slide design, making the product push and pull gently, smooth and silent.



067



SHEARER 4.0

Kitchen storage experience with good looks, hard quality





PULL OUT MULTI PURPOSE BASKET / SHEARER 4.0 

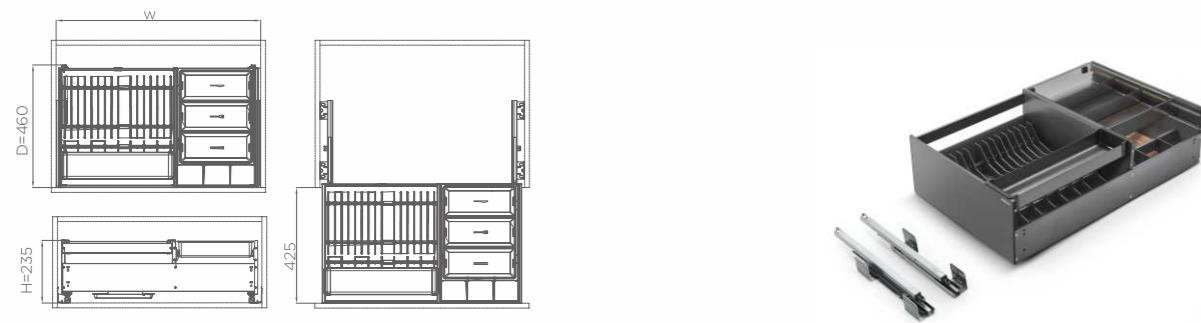

ART. NO	CABINET	W x D x H	MATERIAL	SURFACE
303585	600mm	564x460x235mm	Aluminum	Nano-coating
303584	700mm	664x460x235mm	Aluminum	Nano-coating
303582	800mm	764x460x235mm	Aluminum	Nano-coating
303581	900mm	864x460x235mm	Aluminum	Nano-coating

PULL OUT BASKET / SHEARER 4.0 

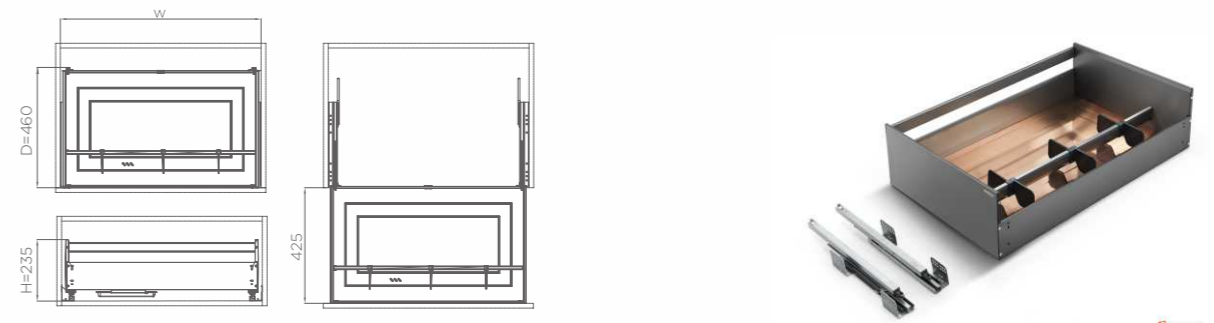

ART. NO	CABINET	W x D x H	MATERIAL	SURFACE
303595	600mm	564x460x235mm	Aluminum	Nano-coating
303594	700mm	664x460x235mm	Aluminum	Nano-coating
303592	800mm	764x460x235mm	Aluminum	Nano-coating
303591	900mm	864x460x235mm	Aluminum	Nano-coating



SHEARER 4.0

A Mechanical Piece Of Art Mega Storage Space

Reshape space and upgrade storage



SEASONING PULL OUT BASKET / SHEARER 4.0

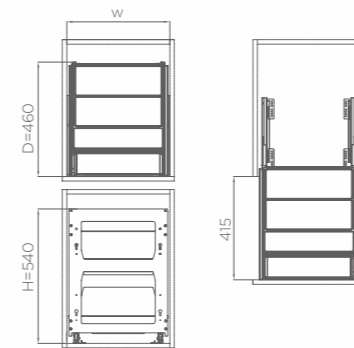

ART. NO	CABINET	W x D x H	MATERIAL	SURFACE
306271	300mm	264x460x540mm	Aluminum	Nano-coating
306272	350mm	314x460x540mm	Aluminum	Nano-coating
306273	400mm	364x460x540mm	Aluminum	Nano-coating
306274	450mm	414x460x540mm	Aluminum	Nano-coating



SHEARER 4.0 PRO / SERIES

SHEARER 4.0 PRO BASE UNITS

Sinking 20mm to solve the problem of collision between the invisible handle and the dishes. Drawer in drawer, fine classification; Fully hidden slide, silk-sliding push and pull; Fish plate design, more inclusive storage. Modular design, detachable functions, cleaning more convenient.



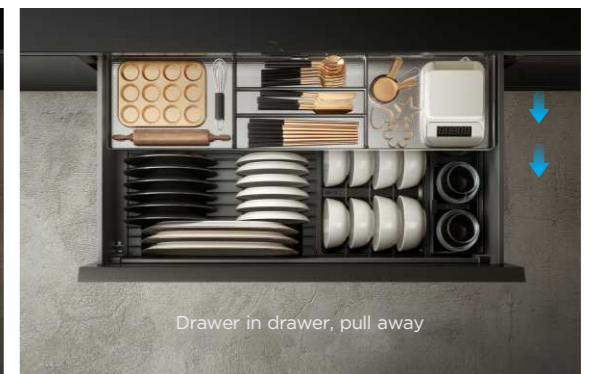

PULL OUT MULTI PURPOSE BASKET / SHEARER 4.0 PRO

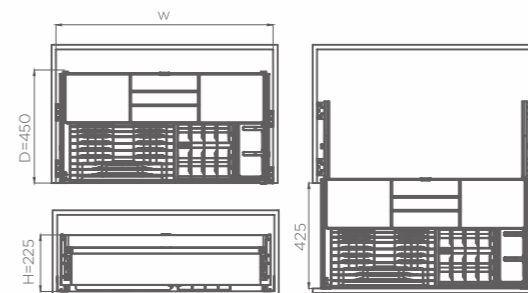

ART. NO	CABINET	W x D x H	MATERIAL	SURFACE
303885	600mm	564x460x235mm	Aluminum	Nano-coating
303884	700mm	664x460x235mm	Aluminum	Nano-coating
303882	800mm	764x460x235mm	Aluminum	Nano-coating
303881	900mm	864x460x235mm	Aluminum	Nano-coating



SHEARER 4.0 *MAGIC DRAWER*

Receive with inherent strong force, to create more likely to receive



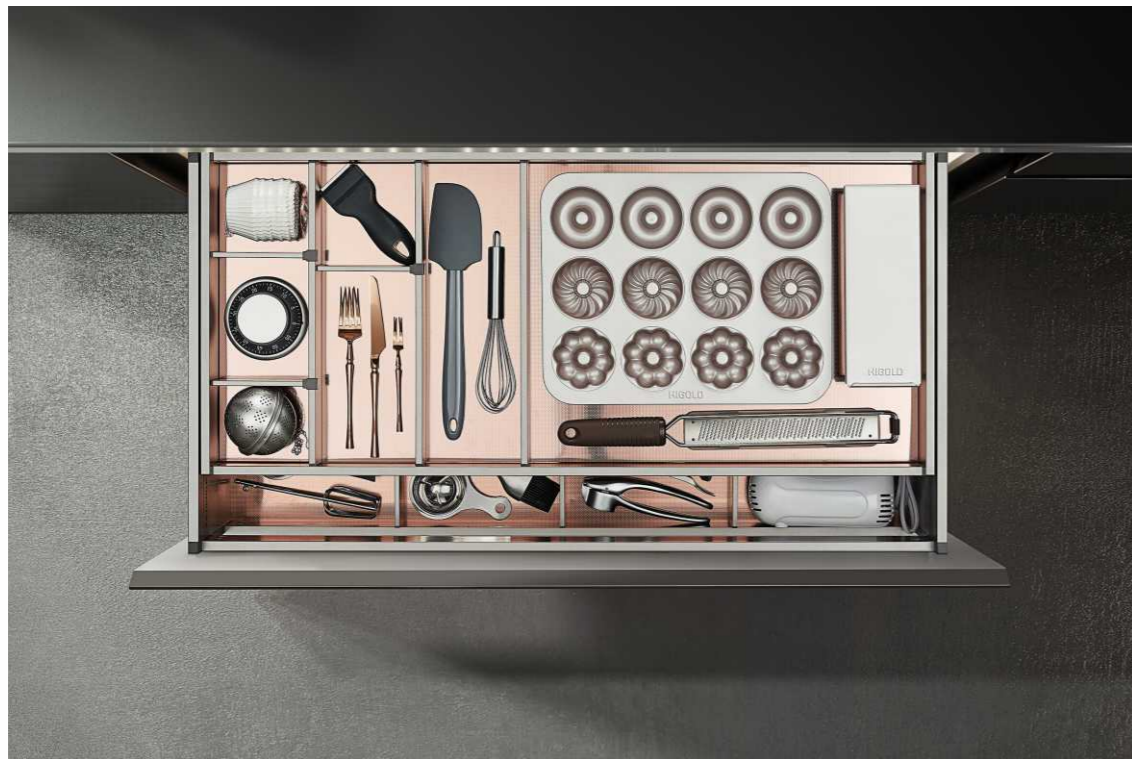

SHEARER 4.0 / **SERIES**

**SHEARER 4.0
MAGIC DRAWER**

Patent NO. : ZL202130163270.5
Patent NO. : ZI202122547978.8

Shearer 4.0 magic drawer , by optimizing the product material, structure, aesthetic design, etc., Will receive a space subdivision, adjustable, meet the demand of users receive a variety of kitchen utensils, clean the kitchen bring comfortable and relaxed.

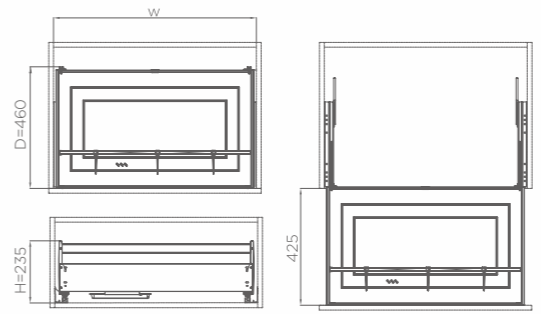

ART. NO	CABINET	W x D x H	MATERIAL	SURFACE
303575	600mm	550x460x235mm	Aluminum	Nano-coating
303574	700mm	650x460x235mm	Aluminum	Nano-coating
303572	800mm	750x460x235mm	Aluminum	Nano-coating
303571	900mm	850x460x235mm	Aluminum	Nano-coating



GHIDORAH BASE UNITS

*The King of Stainless Steel
Plate Pull out Basket*

HIGOLD®



GHIDORAH

Luxurious appearance , Strong storage capacity





PULL OUT MULTI PURPOSE BASKET / CHIDORAH SERIES

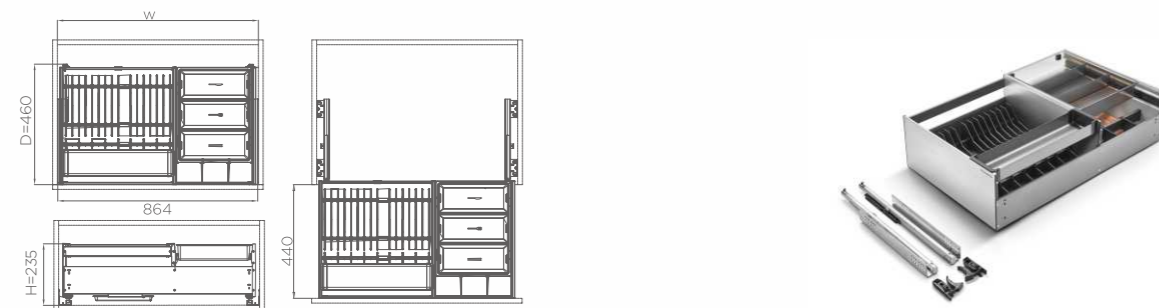

ART. NO	CABINET	W x D x H	MATERIAL	SURFACE
303785	600mm	564x460x235mm	SS	Brushed
303784	700mm	664x460x235mm	SS	Brushed
303782	800mm	764x460x235mm	SS	Brushed
303781	900mm	864x460x235mm	SS	Brushed

PULL OUT BASKET / CHIDORAH SERIES

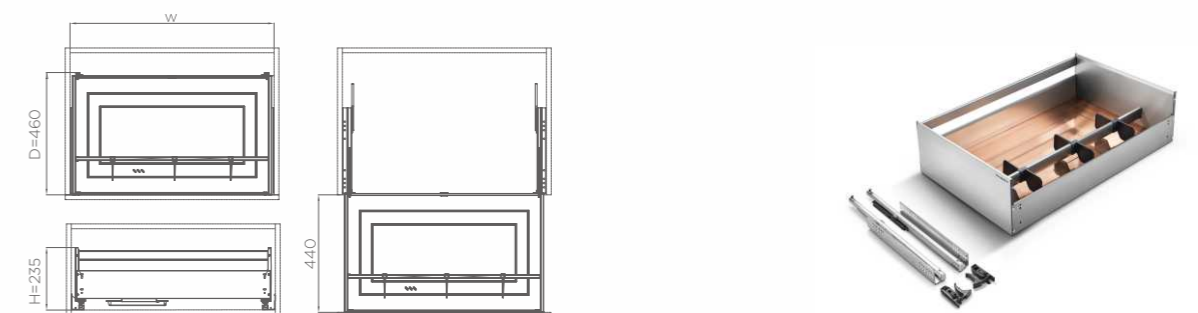

ART. NO	CABINET	W x D x H	MATERIAL	SURFACE
303795	600mm	564x460x235mm	SS	Brushed
303794	700mm	664x460x235mm	SS	Brushed
303792	800mm	764x460x235mm	SS	Brushed
303791	900mm	864x460x235mm	SS	Brushed



SEASONING PULL OUT BASKET / GHIDORAH SERIES

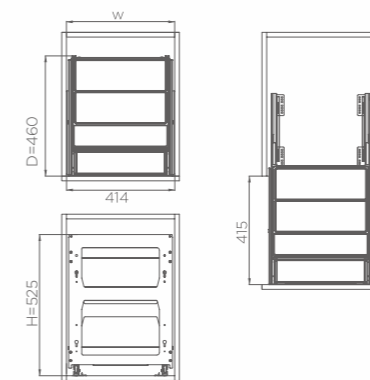

ART. NO	CABINET	W x D x H	MATERIAL	SURFACE
306371	300mm	264x460x525mm	SS	Brushed
306372	350mm	314x460x525mm	SS	Brushed
306373	400mm	364x460x525mm	SS	Brushed
306374	450mm	414x460x525mm	SS	Brushed



L / SERIES

L SERIES UNITS

There are two kinds of baskets, which are respectively made of high-quality stainless steel, electrolytic surface treatment and high-quality steel, four-layer nano-powdered surface treatment. They are super anti-corrosion, anti-rust and durable. The slider is precision manufactured by high-quality steel, and has passed the European standard GS50000 motion test.





THREE-SIDED BASKET / L SERIES (FULL SET)

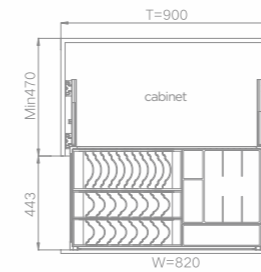

ART. NO	CABINET	W x D x H	MATERIAL	REMARK
308231	600mm	520x443x120mm	Aluminum+SS 304	Soft close
308232	700mm	620x443x120mm	Aluminum+SS 304	Soft close
308236	720mm	640x443x120mm	Aluminum+SS 304	Soft close
308234	800mm	720x443x120mm	Aluminum+SS 304	Soft close
308237	850mm	770x443x120mm	Aluminum+SS 304	Soft close
308235	900mm	820x443x120mm	Aluminum+SS 304	Soft close



TOOL BASKET / L SERIES

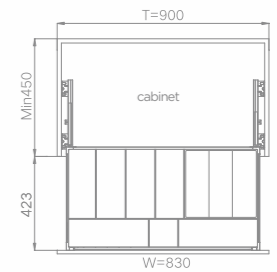

ART. NO	CABINET	W x D x H	MATERIAL	REMARK
308263	350mm	280x423x53mm	Aluminum+SS 304	Soft close
308264	400mm	330x423x53mm	Aluminum+SS 304	Soft close
308265	450mm	380x423x53mm	Aluminum+SS 304	Soft close
308266	500mm	430x423x53mm	Aluminum+SS 304	Soft close
308267	600mm	530x423x53mm	Aluminum+SS 304	Soft close
308268	700mm	630x423x53mm	Aluminum+SS 304	Soft close
308269	720mm	650x423x53mm	Aluminum+SS 304	Soft close
308271	800mm	730x423x53mm	Aluminum+SS 304	Soft close
308272	850mm	780x423x53mm	Aluminum+SS 304	Soft close
308273	900mm	830x423x53mm	Aluminum+SS 304	Soft close



SEASONING BASKET / L SERIES

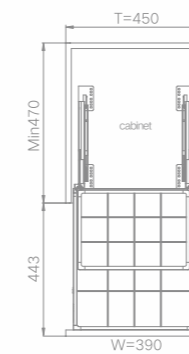

ART. NO	CABINET	W x D x H	MATERIAL	SURFACE
308311	250mm	443X190X120mm	Aluminum+SS 304	Nano-coating
308255	300mm	443x240x120 mm	Aluminum+SS 304	Nano-coating
308256	350mm	443x290x120 mm	Aluminum+SS 304	Nano-coating
308257	400mm	443x340x120 mm	Aluminum+SS 304	Nano-coating
308258	450mm	443x390x120 mm	Aluminum+SS 304	Nano-coating



SHEARER 3.0 / SERIES

SHEARER 3.0 BASE UNITS

Patent NO.: ZL202020957904.4
Patent NO.: ZL202020958081.7
Patent NO.: ZL202130163354.9
Patent NO.: ZL202030056722.5
Patent NO.: ZL202030057132.4
Patent NO.: ZL202020963648.X

Through the innovative multi-layer storage structure with drawers and flexible adjustable partitions, the vacant space above the pull basket can be released for use, so that the unused space can be used for more creative storage, and the pull basket can be comprehensively improved. The utilization rate of the interior space greatly improves the storage capacity of the product. There are five areas on the double layer, each tableware has its own area, the arrangement and storage are clear and clear, and it can be collected at any time, saving worry and effort, helping consumers to develop good storage habits and making the kitchen environment more tidy.





PULL OUT MULTI PURPOSE BASKET / SHEARER 3.0

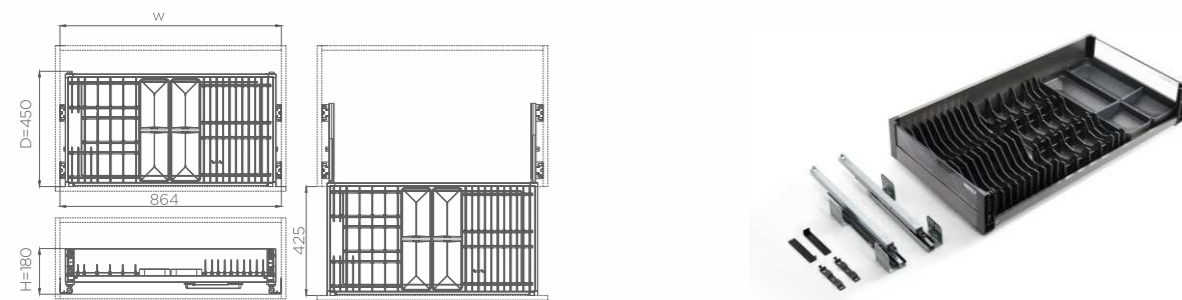

ART. NO	CABINET	W x D x H	MATERIAL	SURFACE
303555	600mm	564x450x180mm	Aluminum+Glass	Nano-coating
303554	700mm	664x450x180mm	Aluminum+Glass	Nano-coating
303552	800mm	764x450x180mm	Aluminum+Glass	Nano-coating
303551	900mm	864x450x180mm	Aluminum+Glass	Nano-coating

PULL OUT BASKET / SHEARER 3.0

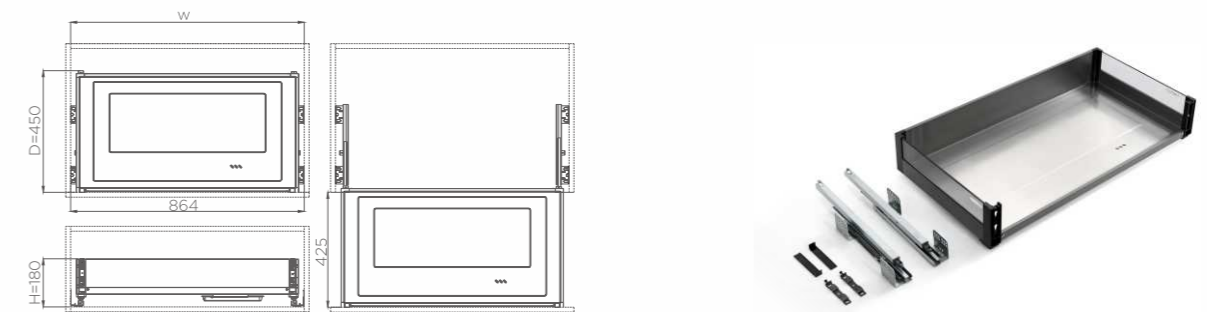

ART. NO	CABINET	W x D x H	MATERIAL	SURFACE
303565	600mm	564x450x180mm	Aluminum+Glass	Nano-coating
303564	700mm	664x450x180mm	Aluminum+Glass	Nano-coating
303562	800mm	764x450x180mm	Aluminum+Glass	Nano-coating
303561	900mm	864x450x180mm	Aluminum+Glass	Nano-coating

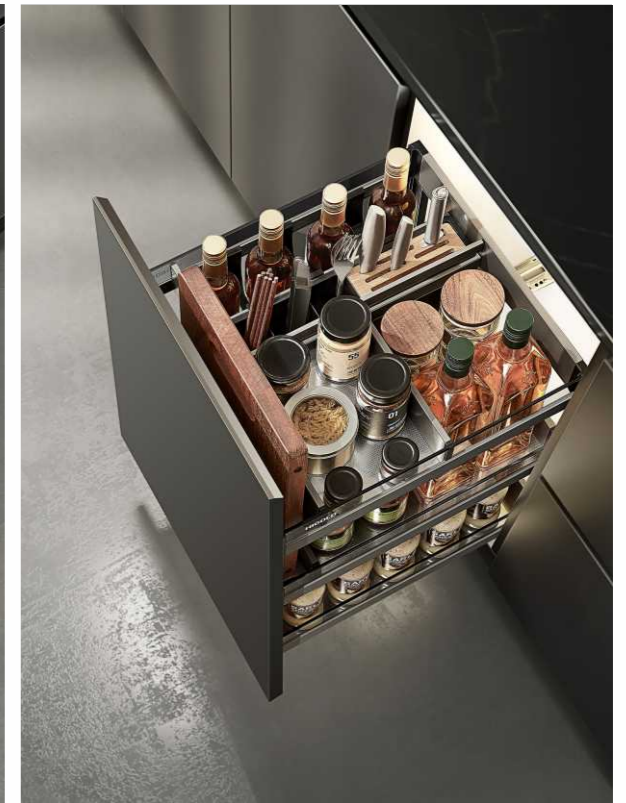

SEASONING PULL OUT BASKET / SHEARER 3.0

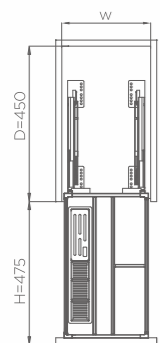

ART. NO	CABINET	W x D x H	MATERIAL	SURFACE
306291	300mm	264x450x475mm	Aluminum+Glass	Nano-coating
306292	350mm	314x450x475mm	Aluminum+Glass	Nano-coating

SEASONING PULL OUT BASKET / SHEARER 3.0

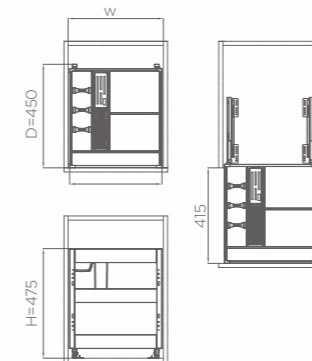

ART. NO	CABINET	W x D x H	MATERIAL	SURFACE
306293	400mm	364x450x475mm	Aluminum+Glass	Nano-coating
306294	450mm	414x450x475mm	Aluminum+Glass	Nano-coating

SHEARER

3.0 mini

*The line must be crossed,
drawing big picture out of small facts*

HIGOLD





SHEARER 3.0 mini / SERIES

SHEARER 3.0mini COMBO THREE SIDES BASKETS

The enlarged glass removes the sense of boundary. Enlarge the proportion of glass, strengthen the lighting in the basket. Smaller size, larger capacity, rezoning the whole basket, using up every inch of space, and increasing the number of dishes by 5%. Module design and free combination, which is drawer but also pull out basket, everything as you like to do.



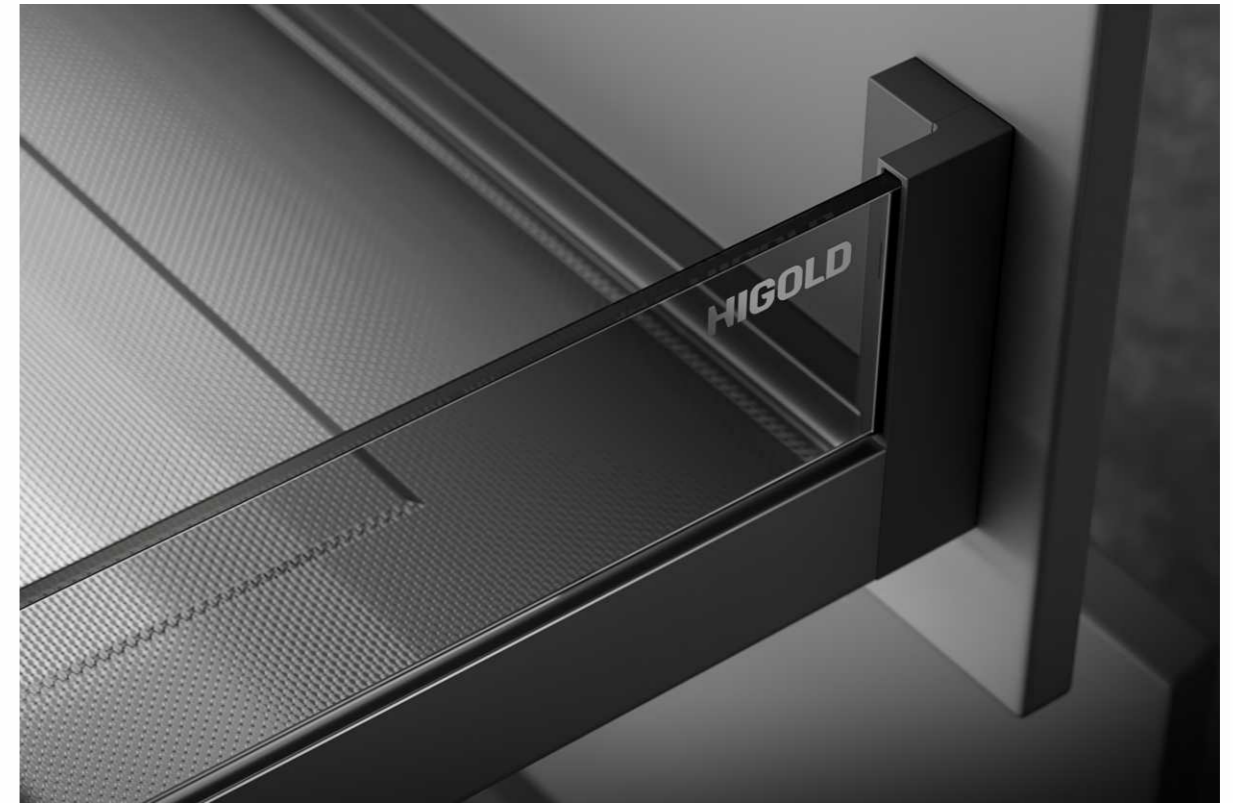

PULL OUT BASKET / SHEARER 3.0 mini (TWO BASKET)



ART. NO	CABINET	W x D x H	MATERIAL	SURFACE
303625	600mm	564x425x180mm	Aluminium+glass	Nano-coating
303624	700mm	664x425x180mm	Aluminium+glass	Nano-coating
303622	800mm	764x425x180mm	Aluminium+glass	Nano-coating
303621	900mm	864x425x180mm	Aluminium+glass	Nano-coating



SHEARER 3.0 mini SEASONING BASKET

*Exquisitely carved and finely
seasoned for storage*

HIGOLD®



SEASONING BASKET / SHEARER 3.0 mini

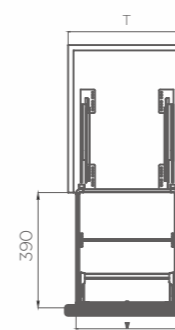
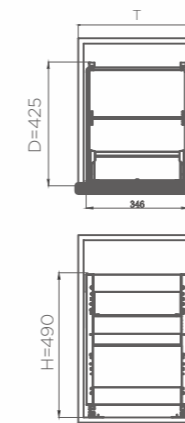

ART. NO	CABINET	W x D x H	MATERIAL	SURFACE
306411	300mm	264x425x490mm	Aluminium+glass	Nano-coating
306412	350mm	314x425x490mm	Aluminium+glass	Nano-coating
306413	400mm	364x425x490mm	Aluminium+glass	Nano-coating
306414	450mm	414x425x490mm	Aluminium+glass	Nano-coating

SHEARER 6.0MINI

*Fashionable style
reconstruct imagination*

HIGOLD®





SHEARER 6.0mini / SERIES

SHEARER 6.0mini BASE UNITS

Through the innovative multi-layer storage structure with drawers and flexible adjustable partitions, the vacant space above the pull basket can be released for use, so that the unused space can be used for more creative storage, and the pull basket can be comprehensively improved. The utilization rate of the interior space greatly improves the storage capacity of the product. There are five areas on the double layer, each tableware has its own area, the arrangement and storage are clear and clear, and it can be collected at any time, saving worry and effort, helping consumers to develop good storage habits and making the kitchen environment more tidy.





PULL OUT MULTI PURPOSE BASKET / SHEARER 6.0mini

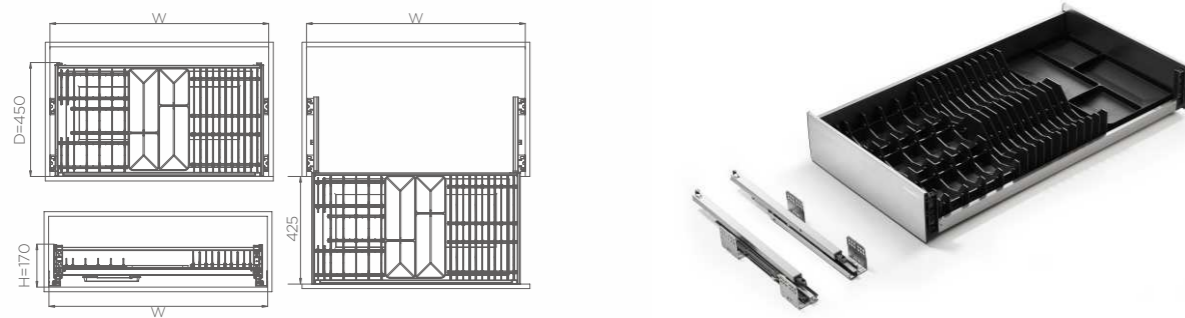

ART.NO	CABINET	W x D x H	MATERIAL	SURFACE
303755	600mm	564x450x170mm	SS	Brushed
303754	700mm	664x450x170mm	SS	Brushed
303752	800mm	764x450x170mm	SS	Brushed
303751	900mm	864x450x170mm	SS	Brushed

PULL OUT BASKET / SHEARER 6.0mini

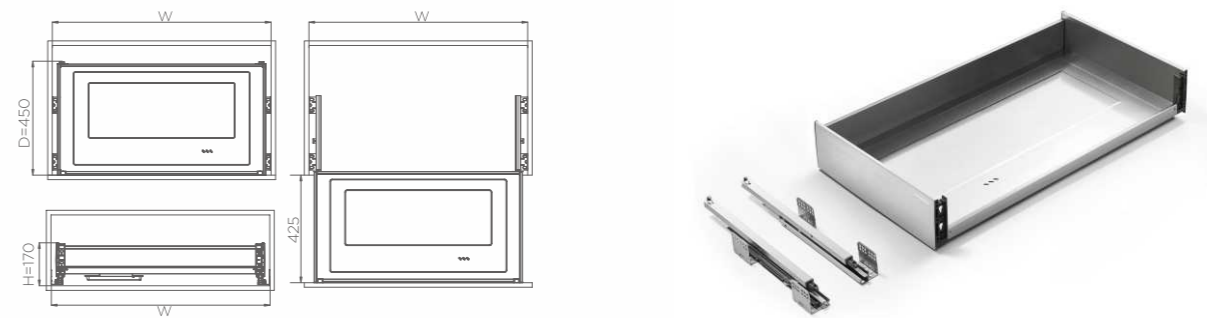

ART.NO	CABINET	W x D x H	MATERIAL	SURFACE
303765	600mm	564x450x170mm	SS	Brushed
303764	700mm	664x450x170mm	SS	Brushed
303762	800mm	764x450x170mm	SS	Brushed
303761	900mm	864x450x170mm	SS	Brushed



SEASONING PULL OUT BASKET / SHEARER 6.0mini

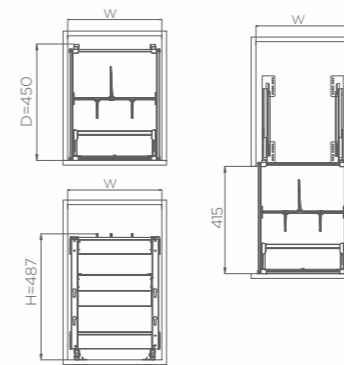

ART.NO	CABINET	W x D x H	MATERIAL	SURFACE
306381	300mm	264x450x487mm	SS	Brushed
306382	350mm	314x450x487mm	SS	Brushed
306383	400mm	364x450x487mm	SS	Brushed
306384	450mm	414x450x487mm	SS	Brushed



JING RAN

*Couture selection
well organized*

Jingran Series Drawer divider system

- Patent NO. : CN2024205141382
- Patent NO. : CN2024301204176
- Patent NO. : CN2024301204161
- Patent NO. : CN2024301204142
- Patent NO. : CN2024301204138
- Patent NO. : CN2024301204123
- Patent NO. : CN2024301204231
- Patent NO. : CN2024301204053
- Patent NO. : CN2024301203987
- Patent NO. : CN2024301203972
- Patent NO. : CN2024301203953

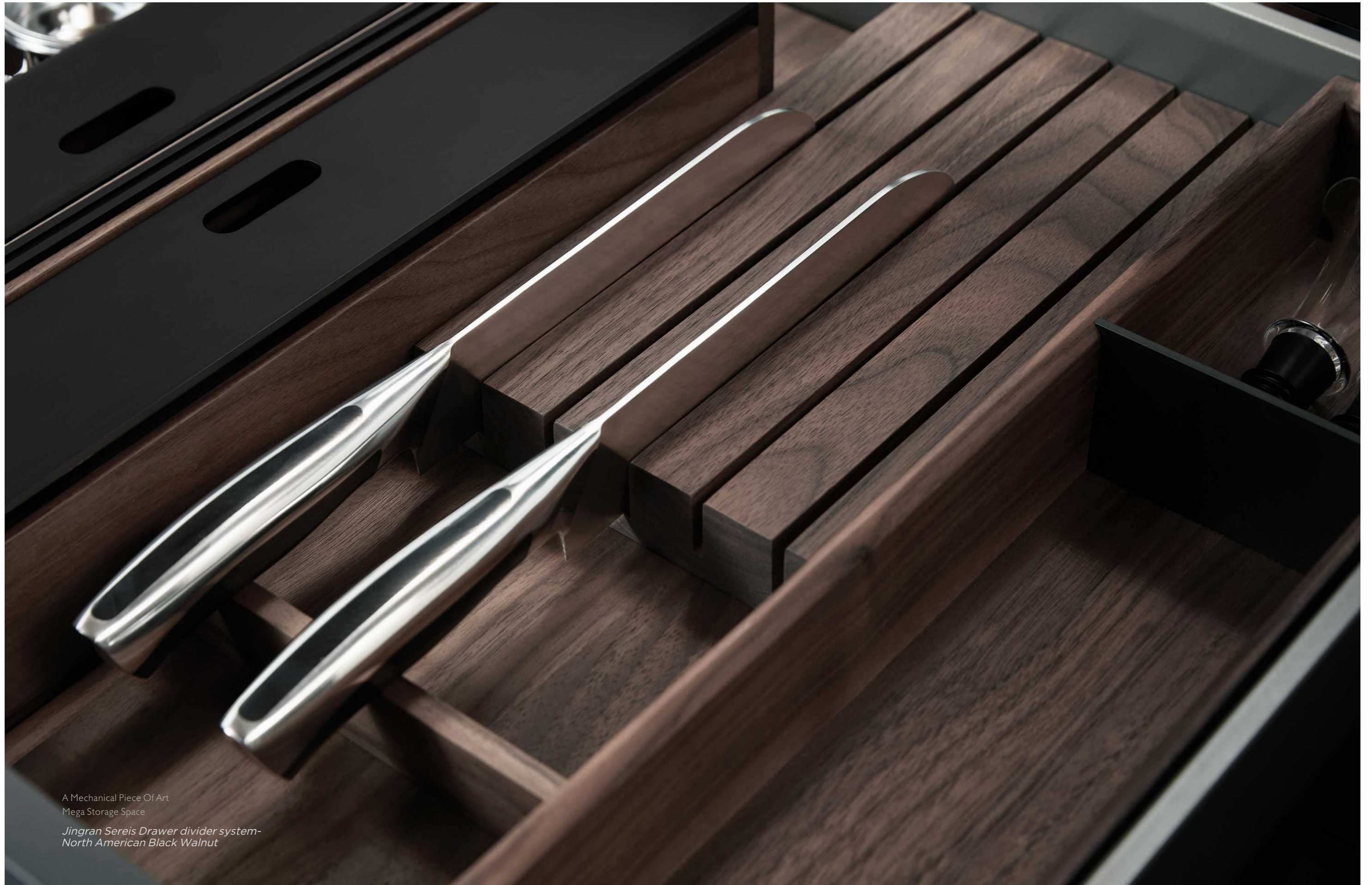

A Mechanical Piece Of Art
Mega Storage Space

*Jingran Sereis Drawer divider system-
North American Black Walnut*

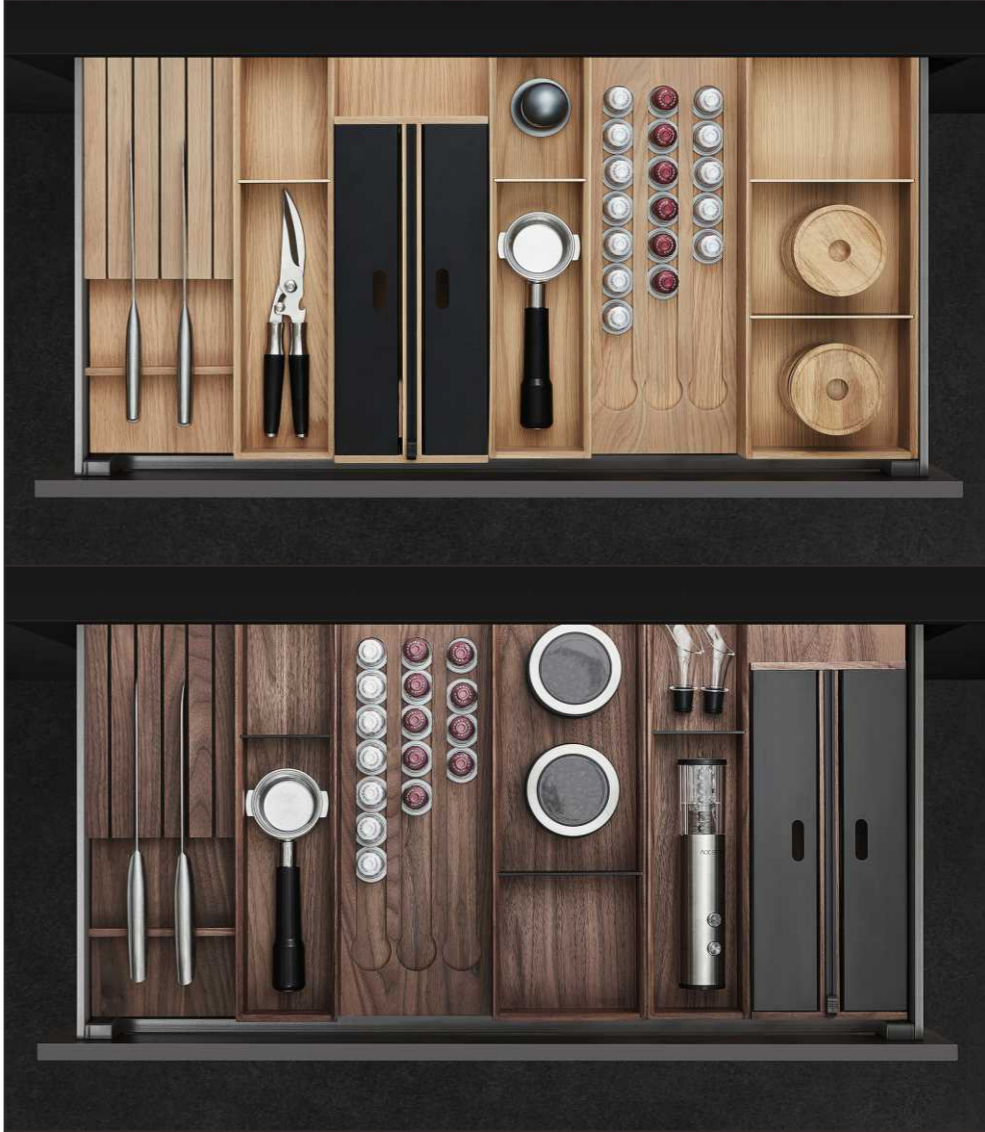

In Order, High-end Customization Well Organized,
Variety of combinations

*Orderly layout,
simple and luxurious life aesthetics.*

Scientific storage, multiple stacking.





Spanning 6,800 kilometers,
Nordic logs were selected under strict quality standards.
JR Series drawer division system, White oak.





A Mechanical Piece Of Art
Mega Storage Space

Jingran Sereis Drawer divider system-
Aluminum

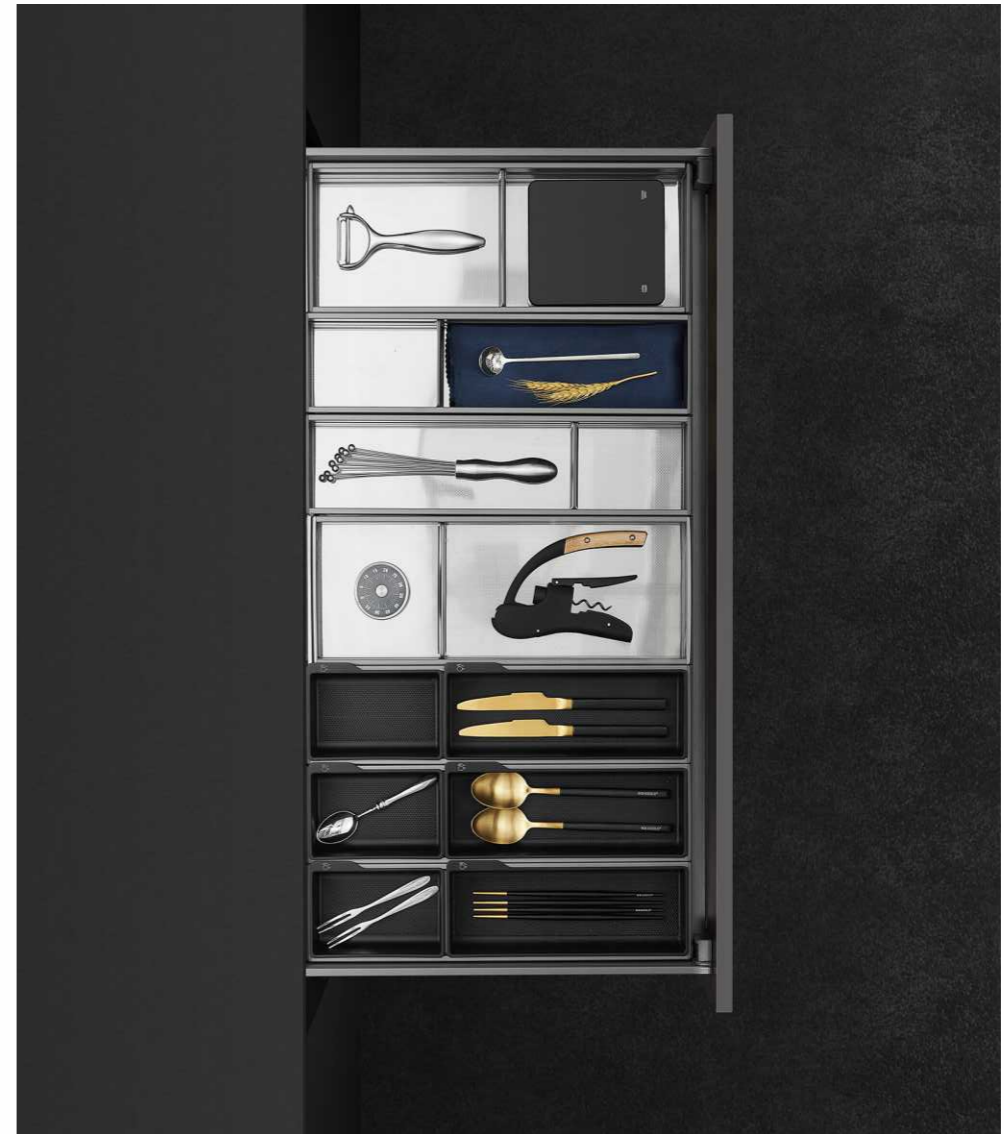





























Minimalist metal creates an infinitely stylish aesthetic in the kitchen..

JING RAN

Jingran Sereis Drawer divider system - Single product





JINGRAN / SERIES

	ART. NO.	NAME	MATERIAL	W X D X H
	301051	Capsule coffee box	North American Black Walnut	150x422x10mm
	301052	knife block	North American Black Walnut	150x422x33mm
	301053	Plastic wrap box	North American Black Walnut	150x422x66mm
	301054	100 separator	North American Black Walnut	100x422x60mm
	301055	150 separator	North American Black Walnut	150x422x60mm
	301056	170 separator	North American Black Walnut	170x422x60mm
	301057	Seasoning container	North American Black Walnut	100x422x58mm
	301058	Grinder rack	North American Black Walnut	150x422x58mm
	301061	150 Cross divider	North American Black Walnut	150x422x48mm
	301062	150 T-type Cross divider	North American Black Walnut	150x422x43mm
	301063	150 U-type Cross divider	North American Black Walnut	150x422x48mm
	301064	200 U-type Cross divider	North American Black Walnut	200x422x48mm
	301065	250 U-type Cross divider	North American Black Walnut	250x422x48mm
	301066	300 U-type Cross divider	North American Black Walnut	300x422x48mm



	301021	Capsule coffee box	European White Oak	150x422x10mm
	301022	knife block	European White Oak	150x422x33mm
	301023	Plastic wrap box	European White Oak	150x422x66mm
	301024	100 separator	European White Oak	100x422x60mm
	301025	150 separator	European White Oak	150x422x60mm
	301026	170 separator	European White Oak	170x422x60mm
	301027	Seasoning container	European White Oak	100x422x58mm
	301028	Grinder rack	European White Oak	150x422x58mm
	301031	150 Cross divider	European White Oak	150x422x48mm
	301032	150 T-type Cross divider	European White Oak	150x422x43mm
	301033	150 U-type Cross divider	European White Oak	150x422x48mm
	301034	200 U-type Cross divider	European White Oak	200x422x48mm
	301035	250 U-type Cross divider	European White Oak	250x422x48mm
	301036	300 U-type Cross divider	European White Oak	300x422x48mm

JINGRAN





Jingran Sereis Drawer divider system - Single product

	ART. NO.	NAME	MATERIAL	W X D X H
	301071	100 Storage box	Aluminum+ABS	100x422x50mm
	301072	150 Storage box	Aluminum+ABS	150x422x50mm
	301073	200 Storage box	Aluminum+ABS	200x422x50mm
	301074	100 Large Tableware Storage box	ABS	99x260x53mm
	301075	100 Small Tableware Storage box	ABS	99x135x53mm

Jingran Sereis Drawer divider system-set

	ART. NO.	NAME	MATERIAL	W X D X H
	900mm	301092	Aluminum+ABS	600x415x50mm Drawer Net Width ≥ 610mm
	600mm	301091	Aluminum+ABS	500x415x50mm Drawer Net Width ≥ 510mm

Jingran Sereis Drawer divider system-set

	ART. NO.	NAME	MATERIAL	W X D X H
	800mm	301083	White oak/ Black walnut	700x422x66mm Drawer Net Width ≥ 700mm
	800mm	301087	White oak/ Black walnut	700x422x66mm Drawer Net Width ≥ 700mm
	700mm	301082	White oak/ Black walnut	600x422x66mm Drawer Net Width ≥ 600mm
	700mm	301086	White oak/ Black walnut	600x422x66mm Drawer Net Width ≥ 600mm
	600mm	301081	White oak/ Black walnut	500x422x66mm Drawer Net Width ≥ 600mm

SHEARER THREE SIDES

PULL OUT BASKET



Aluminum combination

Black walnut combination

White oak combination

PULL OUT BASKET / SHEARER THREE SIDES

Higold Shearer three sides pull out basket, through the optimization of product material, structure, aesthetic design, the storage space is subdivided and adjustable, to meet the needs of users to store a variety of kitchen utensils, experience the comfort and refreshing of a clean kitchen.

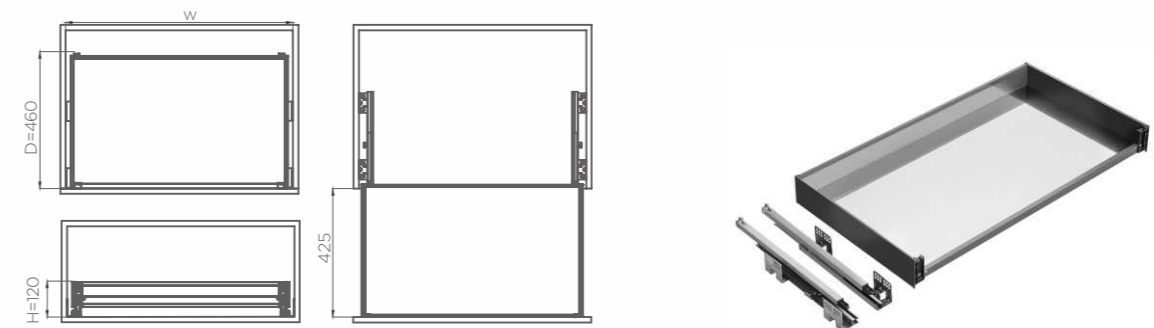

ART. NO	CABINET	W x D x H	MATERIAL	SURFACE
303835	600mm	564x460x120mm	Aluminum	Nano-coating
303834	700mm	664x460x120mm	Aluminum	Nano-coating
303333	800mm	764x460x120mm	Aluminum	Nano-coating
303331	900mm	864x460x120mm	Aluminum	Nano-coating

SHEARER FOUR SIDES

PULL OUT BASKET



Aluminum combination

Black walnut combination

White oak combination

PULL OUT BASKET / SHEARER FOUR SIDES

Sinking 20mm to solve the problem of collision between the invisible handle and the dishes.
 Drawer in drawer design, well classified. Fully hidden slide, dust resistant and sliding smoother.
 Fish plate design, reasonable and more inclusive. Modular design, functional parts can be detachable, cleaning more convenient.

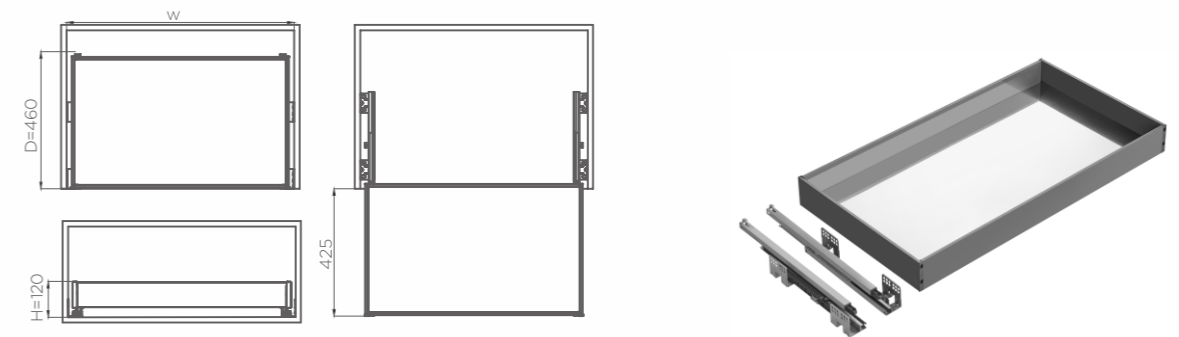

ART. NO	CABINET	W x D x H	MATERIAL	SURFACE
301835	600mm	564x460x120mm	Aluminum	Nano-coating
301834	700mm	664x460x120mm	Aluminum	Nano-coating
301332	800mm	764x460x120mm	Aluminum	Nano-coating
301331	900mm	864x460x120mm	Aluminum	Nano-coating



SHEARER GRAIN BASKETS

Flexible access. Give life a better way





SHEARER / SERIES

SHEARER GRAIN BASKETS

Different capacities, more storage possibilities.
Sealed and moisture-proof, it can be stored for a longer time;
one-click opening and closing makes it more convenient to operate with one hand;
it can be taken out independently and placed anywhere.

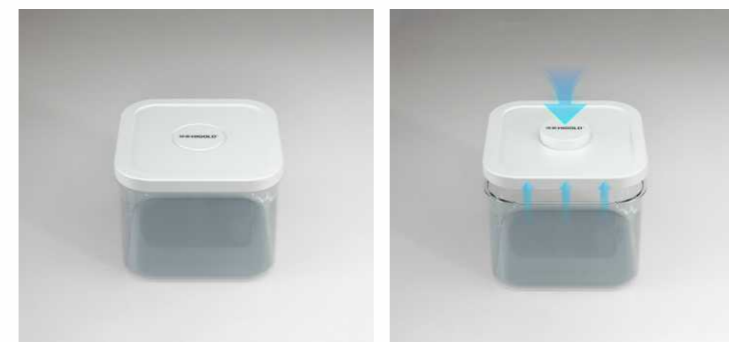

ART. NO	CABINET	W x D x H	MATERIAL	SURFACE
306351	350mm	314x460x540mm	Aluminum+steel	Nano-coating
306352	400mm	364x460x540mm	Aluminum+steel	Nano-coating



MINI PANTRY / SHEARER STYLE (UNIVERSAL MECHANISM)

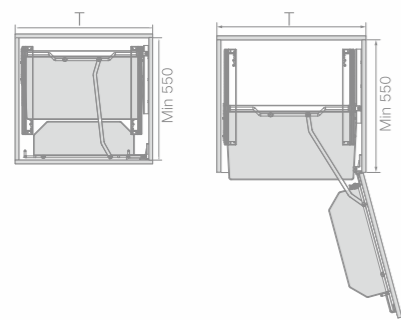

ART.NO	CABINET	W x D x H	MATERIAL	SURFACE
309041	600mm	550x490x590mm	Aluminum	Nano-coating



TRAY BASKET / SHEARER STYLE (UNIVERSAL MECHANISM)

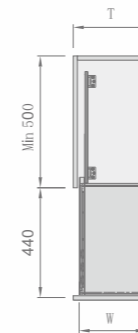

ART.NO	CABINET	W x D x H	MATERIAL	SURFACE	REMARK
304171	200mm	155X465X580mm	Aluminum	Nano-coating	2 Layers
304172	250mm	205X465X580mm	Aluminum	Nano-coating	2 Layers
304173	300mm	255X465X580mm	Aluminum	Nano-coating	2 Layers
304175	200mm	155x465x695mm	Aluminum	Nano-coating	3 Layers
304176	250mm	205x465x695mm	Aluminum	Nano-coating	3 Layers
304177	300mm	255x465x695mm	Aluminum	Nano-coating	3 Layers



CAPRI MID WAY SET

ART.NO	NAME	W x D x H	MATERIAL	ACCESSORIES MATERIAL	REMARK
403194	Hanging Rod	900x40x31.2mm	Aluminum Alloy	/	Nano Coating
	Hook	110x40x46mm	MS	/	Nano Coating
	Upper Shelf	280x105x12mm	MS	/	Nano Coating
	Tall Bottle Shelf	260x262x101mm	MS	/	Nano Coating
	Short Bottle Shelf	260x181x120mm	MS	ABS+Silica Gel	Nano Coating
	Knives Rack	220x262x52mm	MS	ABS	Nano Coating

Over All Size :904x300x126mm

DIAMOND SERIES

Leading Design Perfect Experience





SPACE 3.0 UNITS

DEEP SPACE, FAST ACCESS

HIGOLD®



DIAMOND / SERIES

SPACE 3.0 UNITS

Patent NO.: ZL201420232580.2
 Patent NO.: ZL201511009012.1
 Patent NO.: ZL201430122180.1

The design idea of combining space dream with real storage regarding to wide viewing angle, unobstructed three-side pick up, clear glass, bright plating and silver covering angle, even the basic collocation can help the space capsule series to upgrade the cabinet.

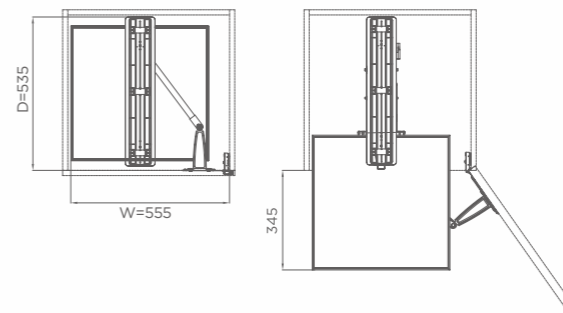

ART.NO	CABINET	W x D x H	MATERIAL	SURFACE	REMARK
205106	500mm	455x535x(1720-2020)mm	Steel	Nano-coating	5 layers
205107	500mm	455x535x(2020-2320)mm	Steel	Nano-coating	6 layers
205116	600mm	555x535x(1720-2020)mm	Steel	Nano-coating	5 layers
205117	600mm	555x535x(2020-2320)mm	Steel	Nano-coating	6 layers

DIAMOND TALL LARDER UNIT

fashion & Life

Give the kitchen a minimalist aesthetic

HIGOLD®





DIAMOND / SERIES

TALL LARDER UNITS

Patent NO.: ZL201922047348.7

Stylish design and innovative details, combined with large capacity storage and functional practicality, make the new interpretation of Higold Kitchen storage hardware system. The smooth opening and closing motion makes storage more convenient; the quality controlled strictly and fully, makes products more durability. Precision production is just to create high-quality, cleaner kitchen for users.

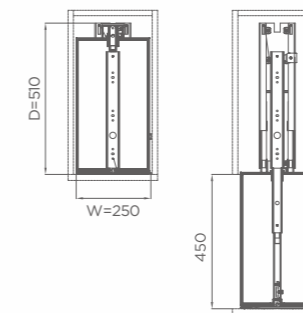

ART.NO	CABINET	W x D x H	MATERIAL	SURFACE	REMARK
201122	300mm	250x510x(1659-2059)mm	Steel	Nano-coating	5 layers
201123	300mm	250x510x(1959-2359)mm	Steel	Nano-coating	6 layers
201125	400mm	350x510x(1659-2059)mm	Steel	Nano-coating	5 layers
201126	400mm	350x510x(1959-2359)mm	Steel	Nano-coating	6 layers

SWIVEL PULL OUT PANTRY

Convenient access, linkage design

HIGOLD®





DIAMOND / SERIES

SWIVEL PULL OUT PANTRY

Patent NO.: ZL201920460643.2
Patent NO.: ZL202220774037.X

Shearer swivel pull out with great capacity provides you a convenient space storage solution for different storage type. The design of door-opening linkage ensures the whole basket can be pulled out to show all items in the cabinet. With the heavy damping slide, the product use the design principle of train guide rail to make sure the slide will runs smoothly under the load.

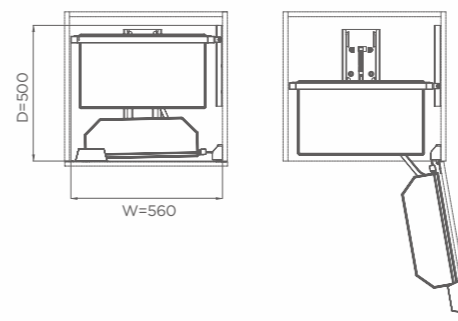

ART.NO	CABINET	W x D x H	MATERIAL	SURFACE	REMARK
202262	450-500mm	410x500x1625mm	Steel	Nano-coating	5 layers
202263	450-500mm	410x500x1825mm	Steel	Nano-coating	6 layers
202265	600mm	560x500x1625mm	Steel	Nano-coating	5 layers
202266	600mm	560x500x1825mm	Steel	Nano-coating	6 layers

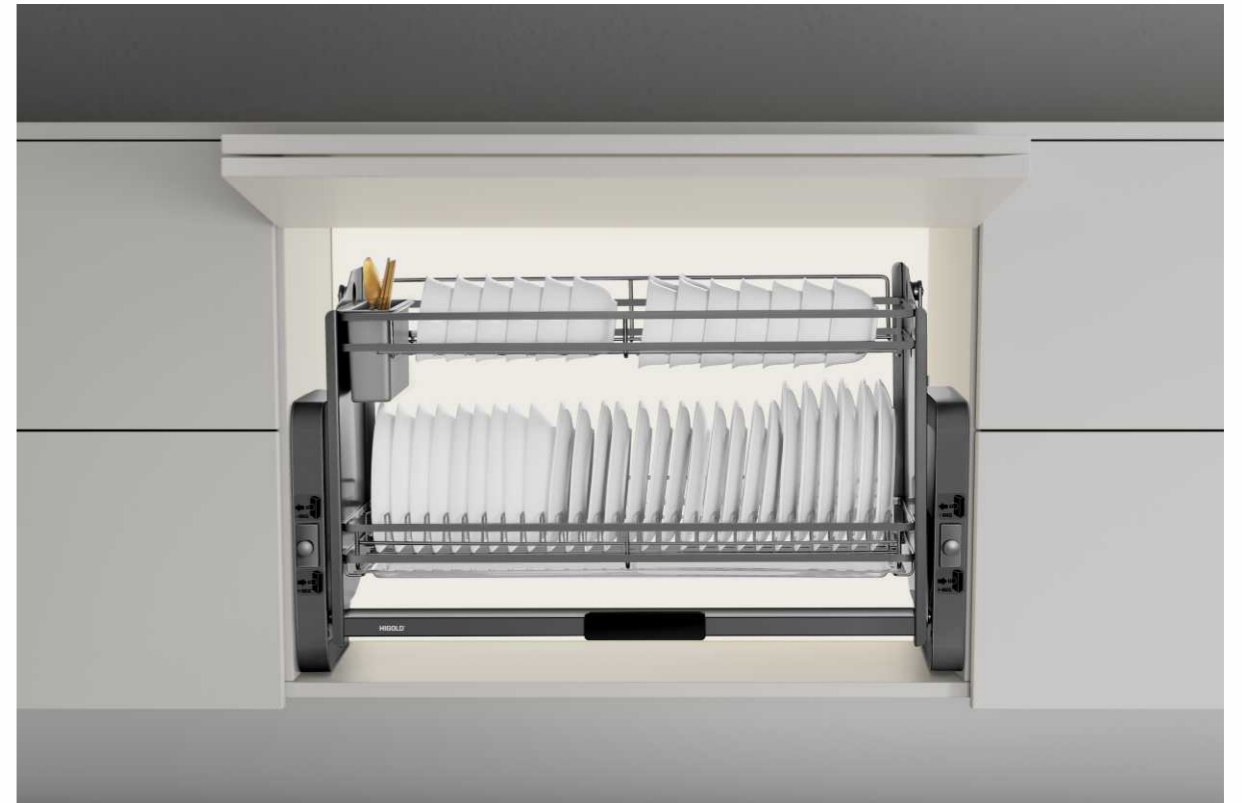

DISH AND BOWL LIET BASKET / DIAMOND STYLE



ART.NO	CABINET	W x D x H	MATERIAL	SURFACE
401331	600mm	564x283x525mm	Steel	Nano-coating
401332	700mm	664x283x525mm	Steel	Nano-coating
401333	800mm	764x283x525mm	Steel	Nano-coating
401334	900mm	864x283x525mm	Steel	Nano-coating

*SWING
TRAYS 3.0*
Smooth & light

HIGOLD®





DIAMOND / SERIES

SWING TRAYS 3.0

Patent NO.: ZL202010424189.2
Patent NO.: ZL202130385109.2

Platinum swing trays 3.0 upgrade, upgrade the mechanical arm, take in new forces. Break-throughs in function and design are more in line with modern people's actual usage habits and needs. From design to production, every detail shows the tough, uncompromising and meticulous top-level craftsmanship.

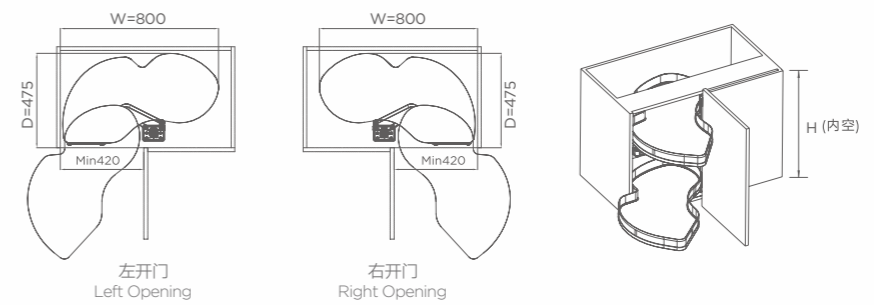

ART.NO	CABINET	W x D x H	MATERIAL	SURFACE	REMARK
101071	≥900mm	800x475x(600-750)mm	Steel	Nano-coating	2 layers / left opening
101072	≥900mm	800x475x(600-750)mm	Steel	Nano-coating	2 layers / right opening



DIAMOND MAGIC CORNER

stable and clever corner storage helper

HIGOLD®



DIAMOND / SERIES

DIAMOND MAGIC CORNER

Patent NO.: ZL202122637437.4
Patent NO.: ZL202122637501.9

The Higold Magic corner realizes a new kitchen storage experience of "I can get what I want", provides a kitchen solution that is both good-looking and usable, and makes the worthless space in kitchen more convenient and cool through the split-link design.

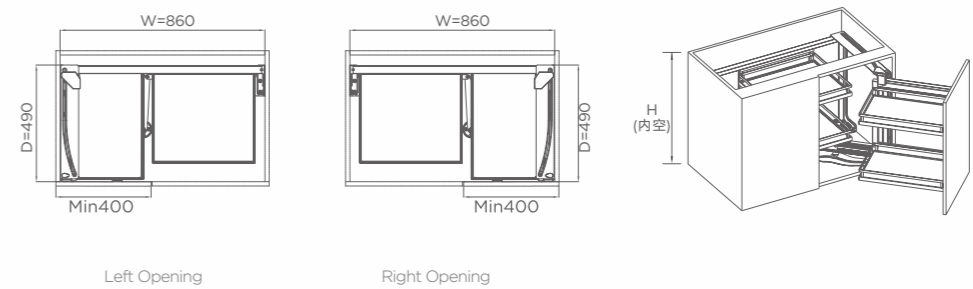

ART.NO	CABINET	W x D x H	MATERIAL	SURFACE	REMARK
101035	≥900mm	860x490x535mm	Steel	Nano-coating	left opening
101036	≥900mm	860x490x535mm	Steel	Nano-coating	right opening



SHOW HAND MAGIC CORNER

Revitalize corner space

HIGOLD®



DIAMOND / SERIES

SHOW HAND MAGIC CORNER

The birth of Show-hand Magci Corner Units makes HIGOLD Corner system be a tiger with wings added. It helps kitchen owners take full advantage of the corner position by pulling the baskets out of the cabinets and helping them to take and place the items to the inner corner.

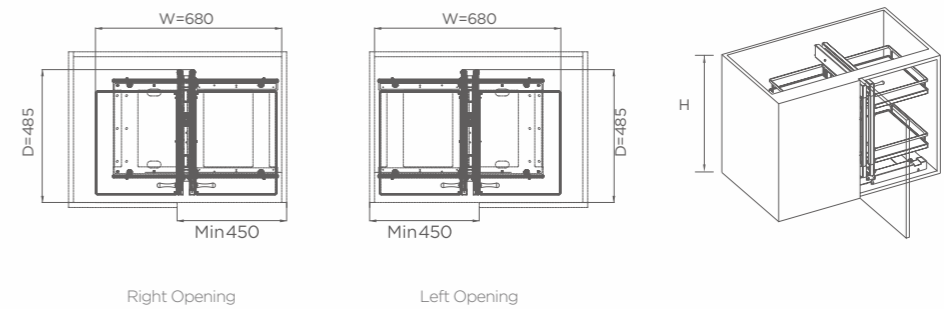

ART.NO	CABINET	W x D x H	MATERIAL	SURFACE	REMARK
101125	≥800mm	680x485x590mm	Steel	Nano-coating	universal opening



STARRY / SERIES

STARRY BASE UNITS

Higold Starry series pull baskets achieve a balance between professionalism and freedom, making the design more warm. The flat baskets of each layer of bowl baskets are universal, and the layout can be freely adjusted according to different storage habits without the need to reassemble. Humanized partition layout, compatible with small pendants and large oil drums, so that every item has a place to belong.





THREE SIDE MULTI-PURPOSE BASKET / STARRY SERIES (TWO BASKETS)

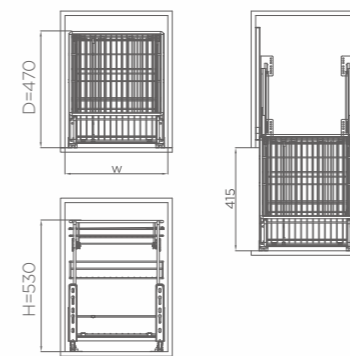

ART. NO	CABINET	W x D x H	MATERIAL	SURFACE
303661	600mm	564x440x180mm	SS 201	Electrolysis
303662	700mm	664x440x180mm	SS 201	Electrolysis
303664	800mm	764x440x180mm	SS 201	Electrolysis
303665	900mm	864x440x180mm	SS 201	Electrolysis



SEASONING PULL OUT BASKET / STARRY SERIES

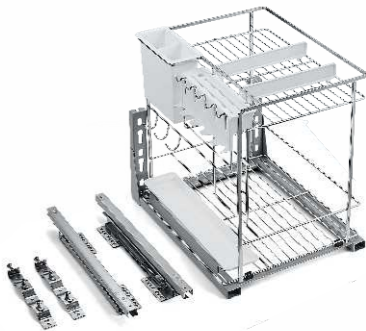
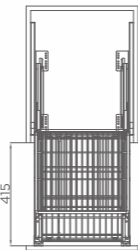
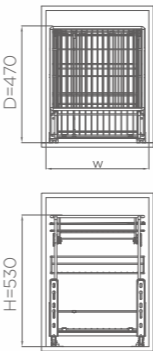

ART. NO	CABINET	W x D x H	MATERIAL	SURFACE
306191	300mm	264x420x465mm	SS + PP plastic	Electrolysis
306192	350mm	314x420x465mm	SS + PP plastic	Electrolysis
306193	400mm	364x420x465mm	SS + PP plastic	Electrolysis
306194	450mm	414x420x465mm	SS + PP plastic	Electrolysis



SIDE BASKET / DIAMOND STYLE

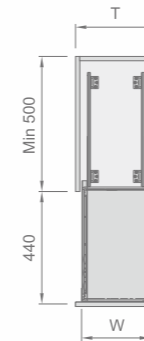

ART.NO	CABINET	W x D x H	MATERIAL	REMARK
304161	150mm	105x462x580mm	Steel	Soft Close / Universal Opening
304162	200mm	155x462x580mm	Steel	Soft Close / Universal Opening
304163	250mm	205x462x580mm	Steel	Soft Close / Universal Opening
304164	300mm	255x462x580mm	Steel	Soft Close / Universal Opening



SIDE BASKET / DIAMOND STYLE

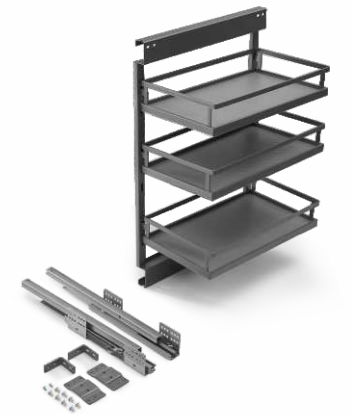
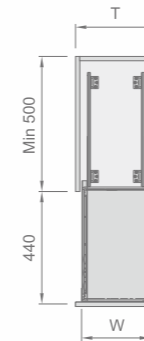

ART.NO	CABINET	W x D x H	MATERIAL	REMARK
304151	150mm	105x462x695mm	Steel	Soft Close / Universal Opening
304152	200mm	155x462x695mm	Steel	Soft Close / Universal Opening
304153	250mm	205x462x695mm	Steel	Soft Close / Universal Opening
304154	300mm	255x462x695mm	Steel	Soft Close / Universal Opening

(Wire basket optional)



FASHION SERIES

Simple, Convenient, Pleasing Experience



SOFT CLOSE TALL UNIT / FASHION STYLE

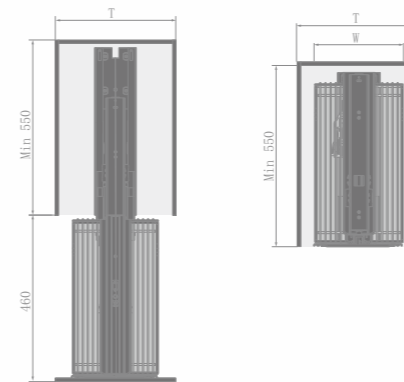

ART. NO	CABINET	W x D x H	MATERIAL	SURFACE	REMARK
201102	300mm	250x510x(1659-2059)mm	Steel	Chrome plating	5 Layers
201103	300mm	250x510x(1959-2359)mm	Steel	Chrome plating	6 Layers
201105	400mm	350x510x(1659-2059)mm	Steel	Chrome plating	5 Layers
201106	400mm	350x510x(1959-2359)mm	Steel	Chrome plating	6 Layers



SWIVEL TANDEM PANTRY / FASHION STYLE

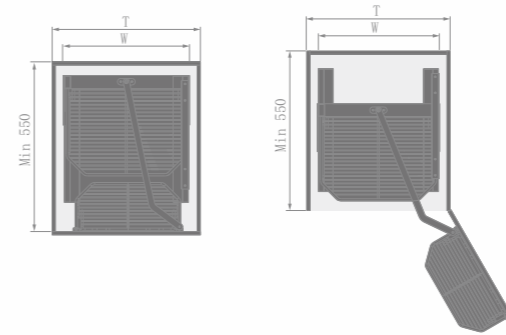

ART. NO	CABINET W x D x HW x D x H	MATERIAL	SURFACE	REMARK
202002	450/500mm 385x530x(1659-2059)mm	Steel	Chrome plating	5 Layers
202003	450/500mm 385x530x(1959-2359)mm	Steel	Chrome plating	6 Layers
202005	600mm 485x530x(1659-2059)mm	Steel	Chrome plating	5 Layers
202006	600mm 485x530x(1959-2359)mm	Steel	Chrome plating	6 Layers



SS DRAINING RACK / FASHION STYLE

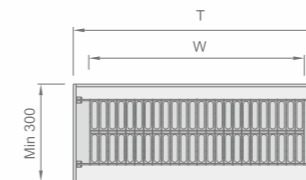

ART.NO	CABINET	W x D x H	MATERIAL	SURFACE
401070	600mm	565x250x(100+45)mm	SS 201 / 304	Chrome plating
401071	700mm	665x250x(100+45)mm	SS 201 / 304	Chrome plating
401072	800mm	765x250x(100+45)mm	SS 201 / 304	Chrome plating
401073	900mm	865x250x(100+45)mm	SS 201 / 304	Chrome plating

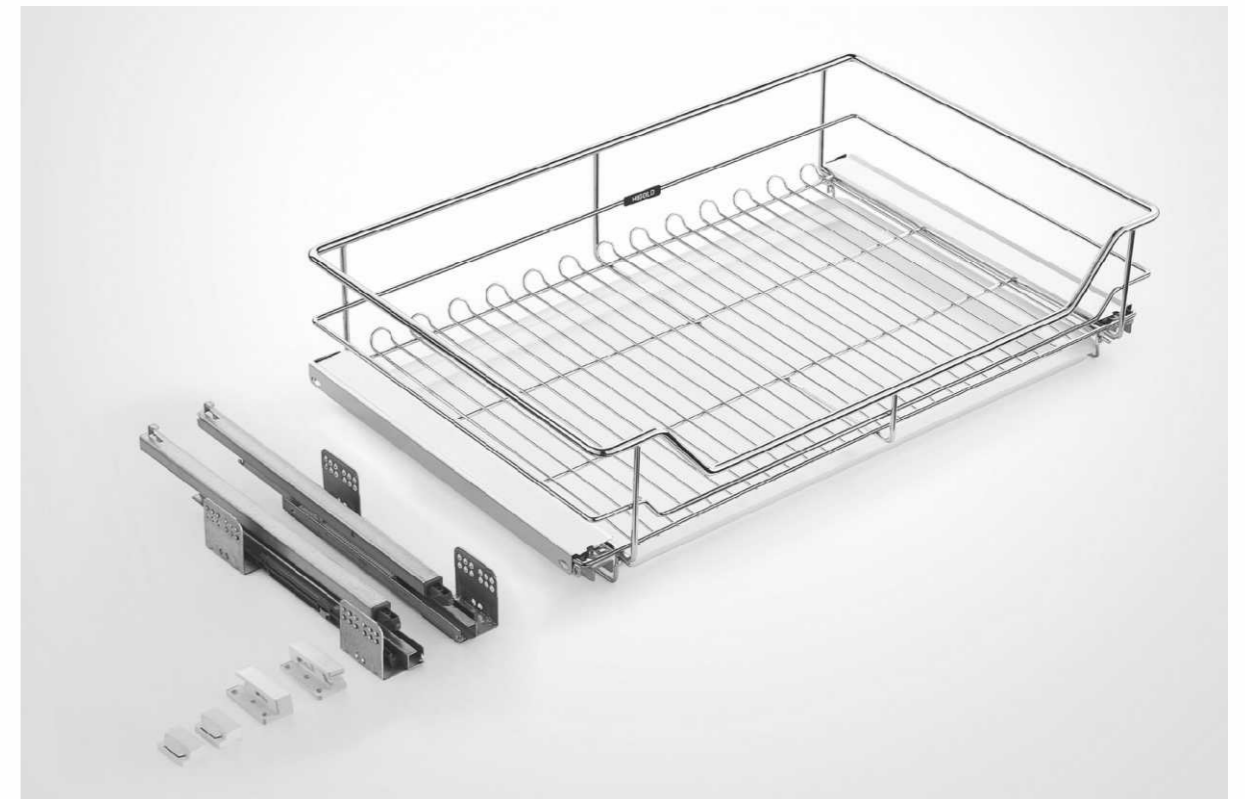

FOUR SIDE PULL OUT BASKET / FASHION STYLE

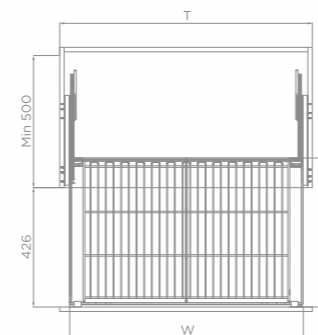

ART. NO	CABINET	W x D x H	MATERIAL	SURFACE	REMARK
301001	400mm	294x450x143mm	Steel	Chrome plating	16 inch
301002	450mm	344x450x143mm	Steel	Chrome plating	16 inch
301004	600mm	494x450x143mm	Steel	Chrome plating	18 inch
301101	700mm	630x465x133mm	Steel	Chrome plating	18 inch
301102	800mm	680x465x133mm	Steel	Chrome plating	18 inch
301103	900mm	730x465x133mm	Steel	Chrome plating	18 inch



SOFT CLOSE MAGIC CORNER / FASHION STYLE

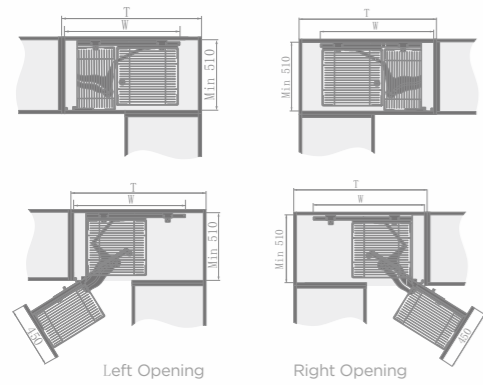

ART. NO	CABINET	W x D x H	MATERIAL	SURFACE	REMARK
101005	900mm	860x490x535mm	Steel	Chrome plating	Left Opening
101006	900mm	860x490x535mm	Steel	Chrome plating	Right Opening



SOFT CLOSE SHOW HAND CORNER / FASHION STYLE

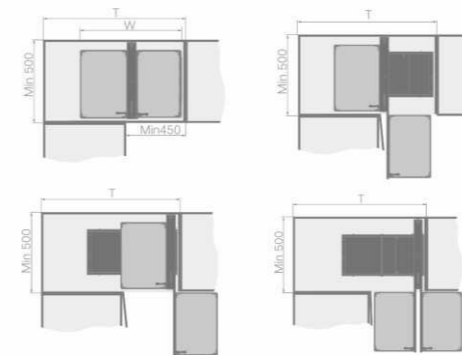

ART. NO	CABINET	W x D x H	MATERIAL	SURFACE	REMARK
101011	800/900mm	680x485x590mm	Steel	Chrome plating	Universal Opening

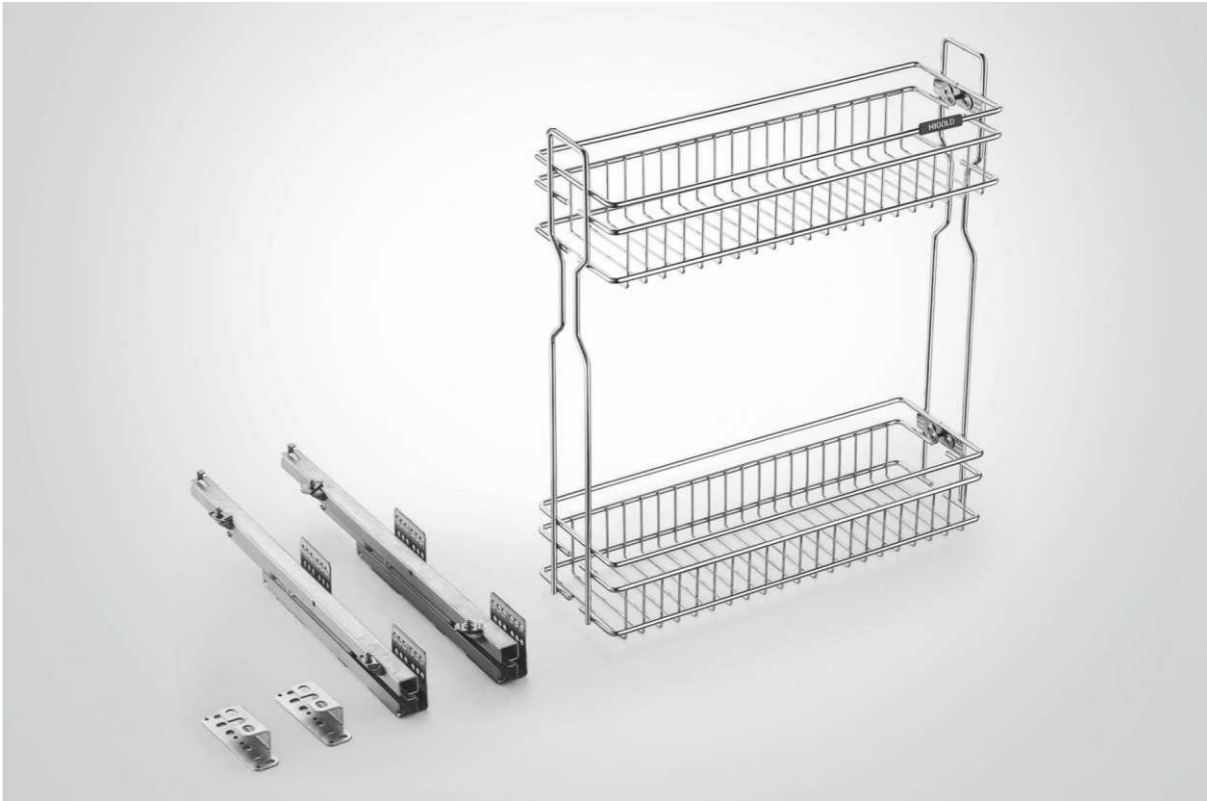

NARROW BASKET / FASHION STYLE

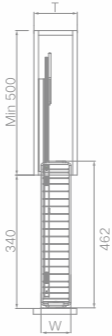

ART. NO	CABINET	W x D x H	MATERIAL	SURFACE	REMARK
304098	150mm	110x460x490mm	Steel	Chrome plating	left/right side
304099	200mm	160x460x490mm	Steel	Chrome plating	left/right side



BASE BASKET / FASHION STYLE

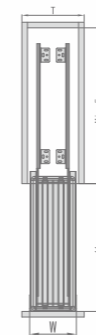

ART. NO	CABINET	W x D x H	MATERIAL	SURFACE
304084	150mm	100x450x520mm	Steel	Chrome plating
304081	200mm	150x450x520mm	Steel	Chrome plating
305001	300mm	235x450x520mm	Steel	Chrome plating

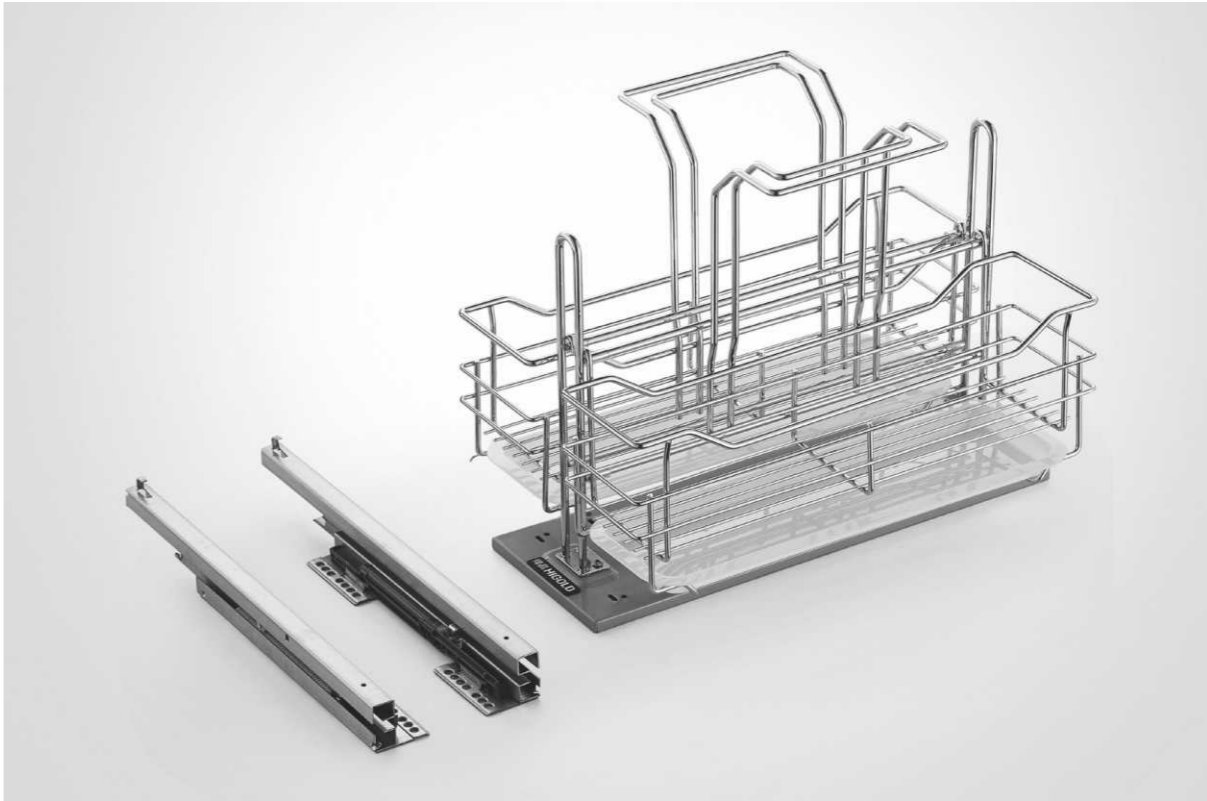

CLEAR-LIQUID RACK / FASHION STYLE

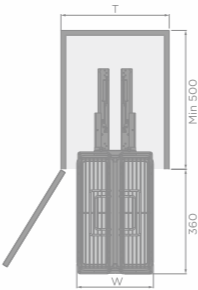

ART. NO	CABINET	W x D x H	MATERIAL	SURFACE
307020	350mm	314x465x405mm	Steel	Chrome plating

PLATINUM SERIES

Receiving Life More Imagination





PLATINUM2.0 / SERIES

PLATINUM 2.0 BASE UNITS

Patent NO. : ZL202230562498.6
Patent NO. : ZL202230562901.5
Patent NO. : ZL201521116688.6

By adding dividers that can be adjusted and pulled flexibly into the pull basket, the empty space above the pull basket can be released and utilized, making the unused space have more creative storage possibilities, comprehensively improving the utilization rate of space in the basket, and improving the storage ability of products. There are two layers and five sections, with separate sections for each type of cutlery. Make consumers' kitchen storage more convenient, help them develop good habits, make the kitchen more cleaner





PULL OUT MULTI PURPOSE BASKET / PLATINUM 2.0

PULL OUT BASKET / PLATINUM 2.0

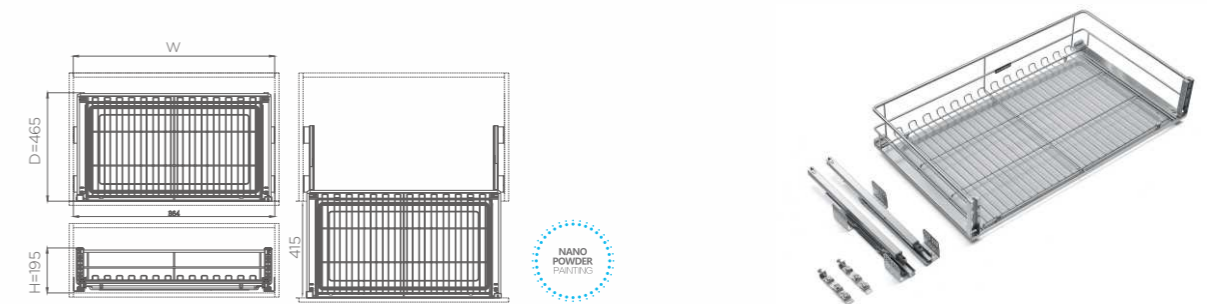
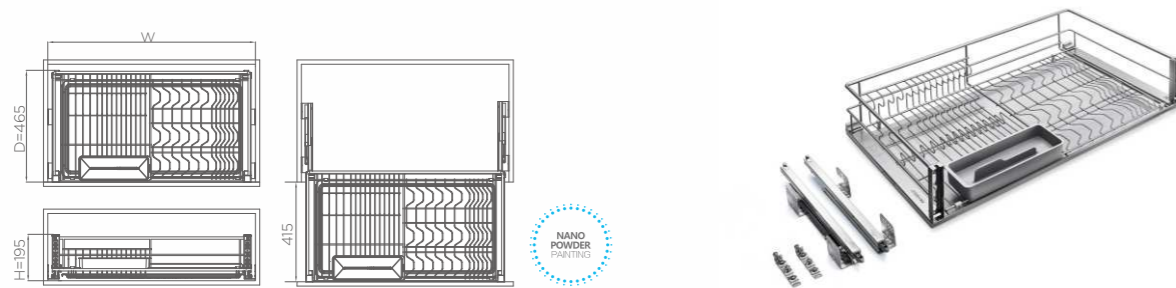

ART.NO	CABINET	W x D x H	MATERIAL	SURFACE
303605S	600mm	564x465x195mm	Steel	Nano-coating
303601S	700mm	664x465x195mm	Steel	Nano-coating
303602S	800mm	764x465x195mm	Steel	Nano-coating
303603S	900mm	864x465x195mm	Steel	Nano-coating

ART.NO	CABINET	W x D x H	MATERIAL	SURFACE
303695S	600mm	564x465x195mm	Steel	Nano-coating
303694S	700mm	664x465x195mm	Steel	Nano-coating
303692S	800mm	764x465x195mm	Steel	Nano-coating
303691S	900mm	864x465x195mm	Steel	Nano-coating



SEASONING PULL OUT BASKET / PLATINUM 2.0

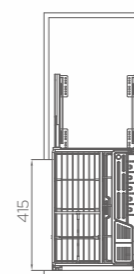
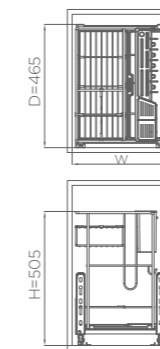

ART.NO	CABINET	W x D x H	MATERIAL	SURFACE
306031S	300mm	264x465x505mm	Steel	Nano-coating
306021S	350mm	314x465x505mm	Steel	Nano-coating
306041S	400mm	364x465x505mm	Steel	Nano-coating
306051S	450mm	414x465x505mm	Steel	Nano-coating



STARLINK 2.0 / SERIES

STARLINK 2.0 BASE UNITS

Patent NO.: ZL201521116688.6

Higold Star Link Series storage system has a newly upgraded drawer-in-drawer design and a revolutionary optimization of the multilayer storage structure, which greatly improves the storage function of the product. Innovative magnetic slider makes it easier to pick and place.





STAR LINK 2.0

Revolutionary optimization of multi-layer storage structure





PULL OUT MULTI PURPOSE BASKET / STAR LINK 2.0

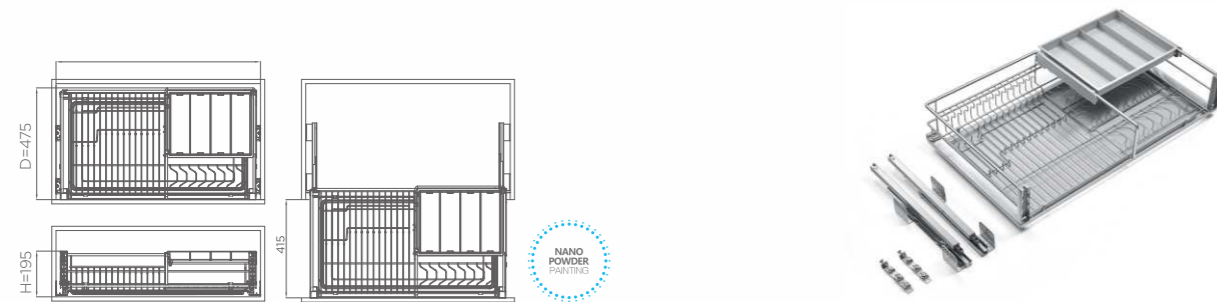

ART.NO	CABINET	W x D x H	MATERIAL	SURFACE
303675S	600mm	564x475x195mm	Steel	Nano-coating
303674S	700mm	664x475x195mm	Steel	Nano-coating
303672S	800mm	764x475x195mm	Steel	Nano-coating
303671S	900mm	864x475x195mm	Steel	Nano-coating



PULL OUT BASKET / STAR LINK 2.0

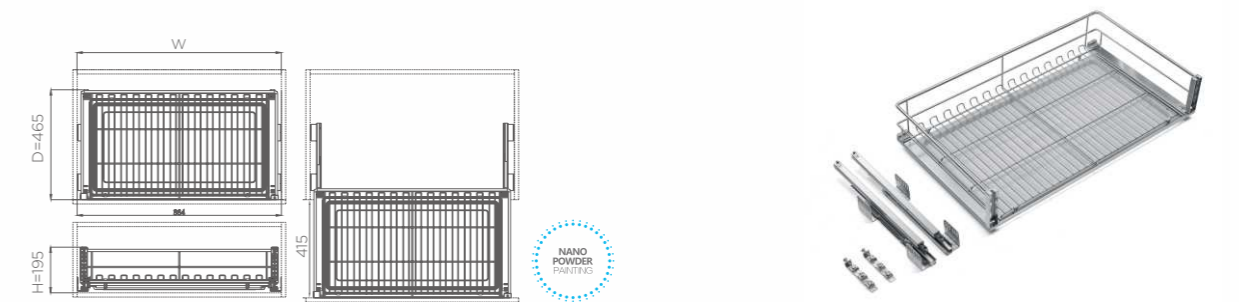

ART.NO	CABINET	W x D x H	MATERIAL	SURFACE
303695S	600mm	564x465x195mm	Steel	Nano-coating
303694S	700mm	664x465x195mm	Steel	Nano-coating
303692S	800mm	764x465x195mm	Steel	Nano-coating
303691S	900mm	864x465x195mm	Steel	Nano-coating



SEASONING PULL OUT BASKET / STAR LINK 2.0



ART.NO	CABINET	W x D x H	MATERIAL	SURFACE
306301S	300mm	264x470x530mm	Steel	Nano-coating
306302S	350mm	314x470x530mm	Steel	Nano-coating
306303S	400mm	364x470x530mm	Steel	Nano-coating
306304S	450mm	414x470x530mm	Steel	Nano-coating



MARTIN 2.0 / SERIES

MARTIN 2.0 BASE UNITS

Patent NO. : ZL202230602487.6
Patent NO. : ZL202230602487.6
Patent NO. : ZL202230562487.8

Martin 2.0 pull basket adopts fashionable high-end design, reflecting the artistic aesthetics of the basket body, Separable detachable tray design allows users to independently take out the tray and store the dishes. After putting away the cutlery, the user can put the tray back on the basket as a whole. The new design allows the basket to increase the storage space of dishes, making storage more convenient and practical.

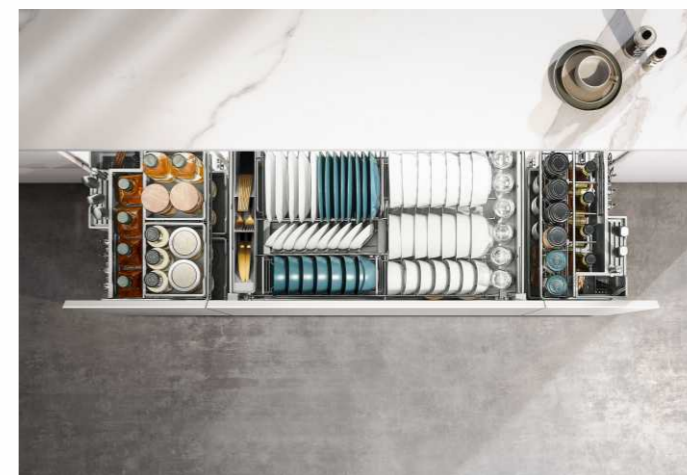



PULL OUT MULTI PURPOSE BASKET / MARTIN 2.0

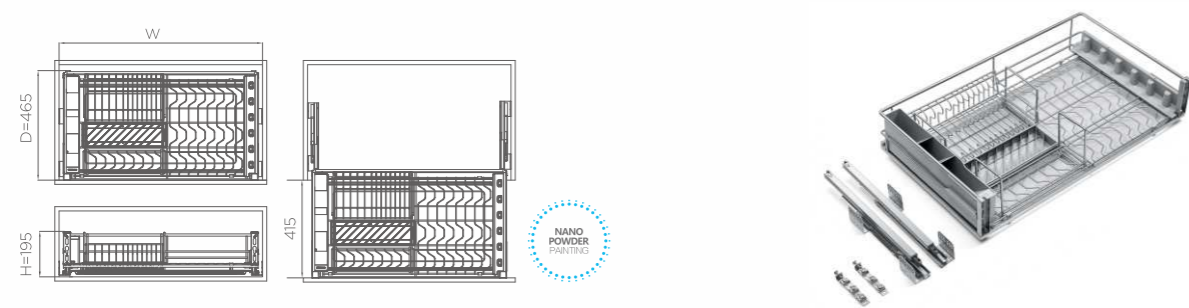

ART.NO	CABINET	W x D x H	MATERIAL	SURFACE
303401S	600mm	564x465x195mm	Steel	Nano-coating
303402S	700mm	664x465x195mm	Steel	Nano-coating
303404S	800mm	764x465x195mm	Steel	Nano-coating
303405S	900mm	864x465x195mm	Steel	Nano-coating

PULL OUT BASKET / MARTIN 2.0

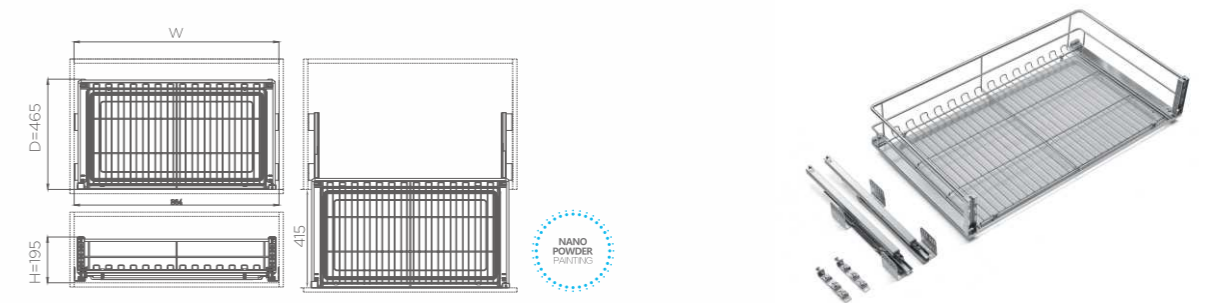

ART.NO	CABINET	W x D x H	MATERIAL	SURFACE
303695S	600mm	564x465x195mm	Steel	Nano-coating
303694S	700mm	664x465x195mm	Steel	Nano-coating
303692S	800mm	764x465x195mm	Steel	Nano-coating
303691S	900mm	864x465x195mm	Steel	Nano-coating

MARTIN 2.0 BASE UNITS

Refined structural design,
accessories can be taken out separately,
making it more convenient to use





SEASONING PULL OUT BASKET / MARTIN 2.0



ART.NO	CABINET	W x D x H	MATERIAL	SURFACE
306091S	300mm	264x465x505mm	Steel	Nano-coating
306092S	350mm	314x465x505mm	Steel	Nano-coating

SEASONING PULL OUT BASKET / MARTIN 2.0



ART.NO	CABINET	W x D x H	MATERIAL	SURFACE
306093S	400mm	364x465x505mm	Steel	Nano-coating
306094S	450mm	414x465x505mm	Steel	Nano-coating

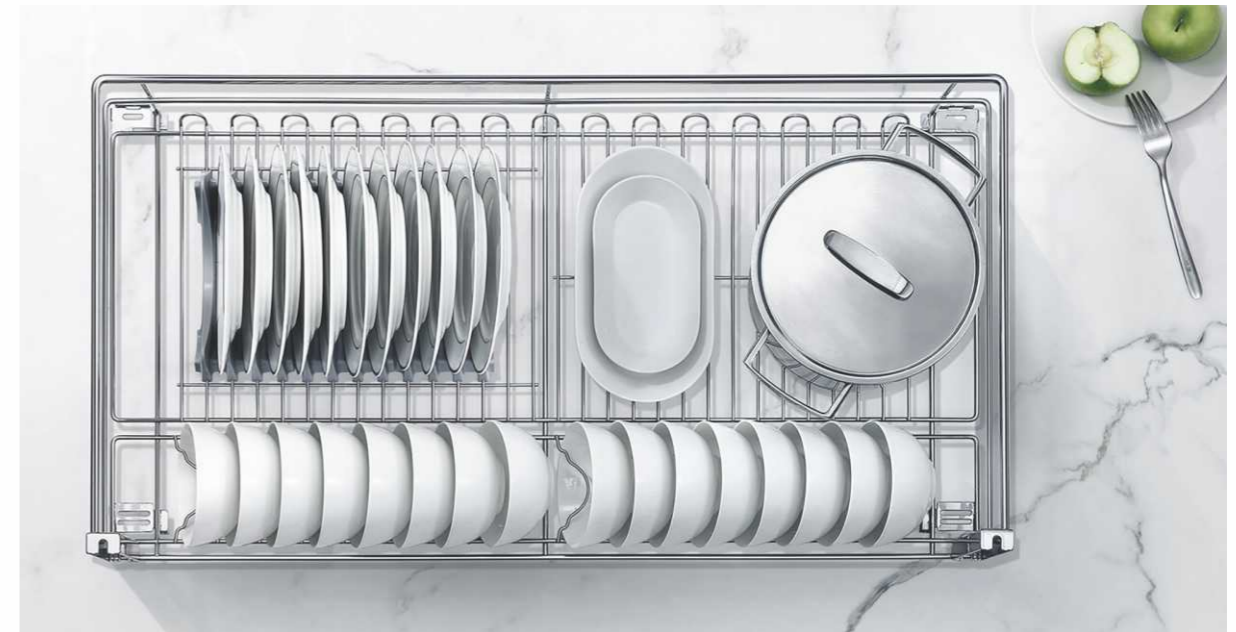

PULL OUT BASKET / M SEREIS (TWO BASKETS)

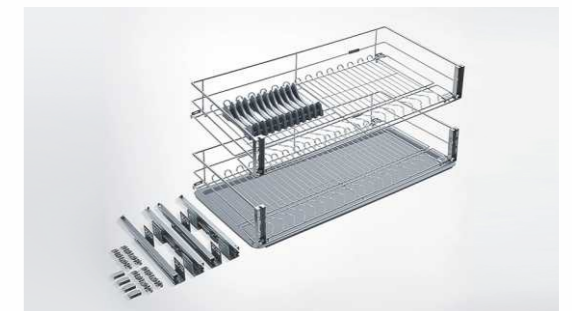
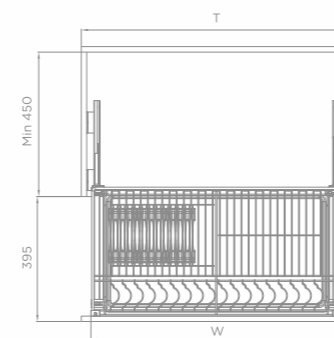

ART. NO	CABINET	W x D x H	MATERIAL	SURFACE
303271	600mm	564x440x180mm	Steel	Nano-coating
303272	700mm	664x440x180mm	Steel	Nano-coating
303274	800mm	764x440x180mm	Steel	Nano-coating
303275	900mm	864x440x180mm	Steel	Nano-coating



MULTI PURPOSE BASKET / M SEREIS

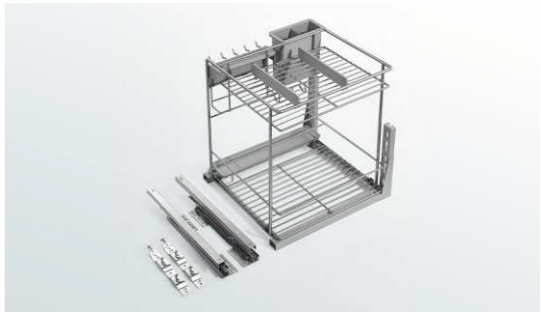
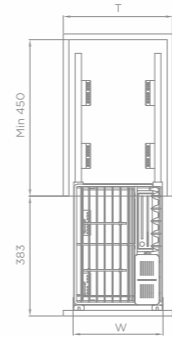

ART. NO	CABINET	W x D x H	MATERIAL	SURFACE
306181	300mm	264x420x465mm	Steel	Nano-coating
306182	350mm	314x420x465mm	Steel	Nano-coating
306183	400mm	364x420x465mm	Steel	Nano-coating
306184	450mm	386x420x465mm	Steel	Nano-coating



S.S. WASTEBIN

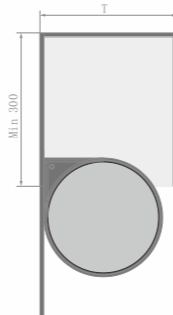

ART. NO	CABINET	W x D x H	MATERIAL	REMARK
307015	350mm	Ø260xH315mm	SS 201	8L
307016	450mm	Ø290xH350mm	SS 201	14L

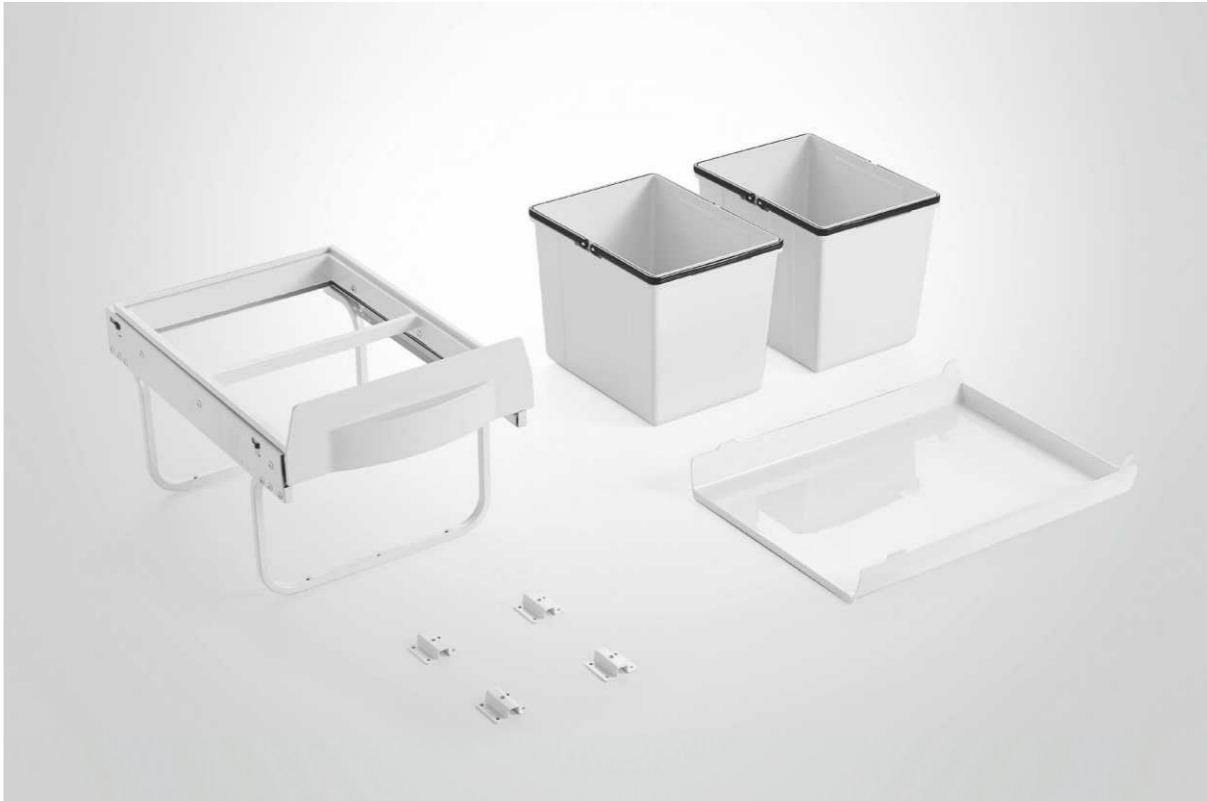

UNDER SINK WASTEBIN

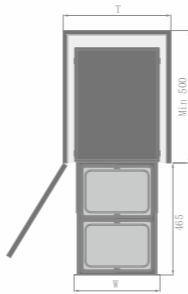

ART. NO	CABINET	W x D x H	MATERIAL	REMARK
307013	400mm	345x500x310mm	Plastic	2x15L

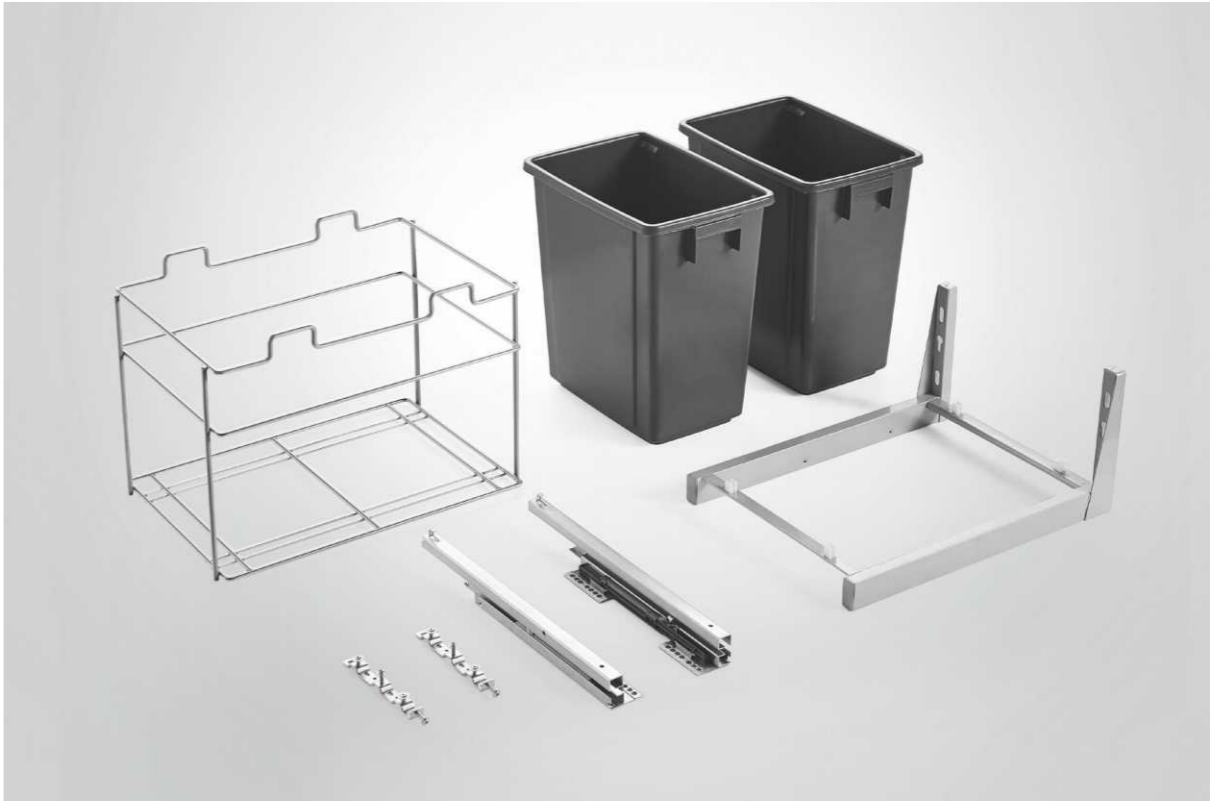

SOFT CLOSE WASTEBIN

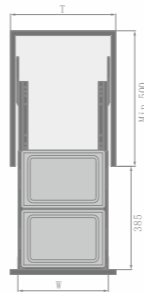

ART. NO	CABINET	W x D x H	MATERIAL	REMARK
307012	450mm	345x475x440mm	Steel+Plastic	2x17L



US STYLE WASTEBIN

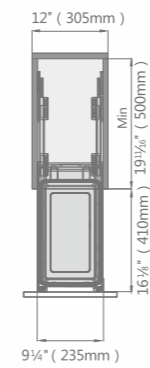

ART. NO	CABINET	W x D x H	MATERIAL	REMARK
307027	300mm	235x465x500mm	Steel+Plastic	1x28L



US STYLE WASTEBIN

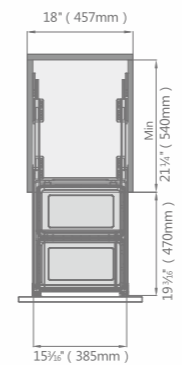

ART. NO	CABINET	W x D x H	MATERIAL	REMARK
307026	450mm	385x520x500mm	Steel+Plastic	2x28L

WARDROBE HARDWARE

HIGOLD®

Leading Design
Perfect Experience



WARDROBE

Higold wardrobe storage function hardware system, multi-dimensional display practical storage ingenuity and space aesthetic design, the integration of pragmatism and Romanticism, for consumers to provide a full set of cloakroom storage solution, to create a life of grace and ease.

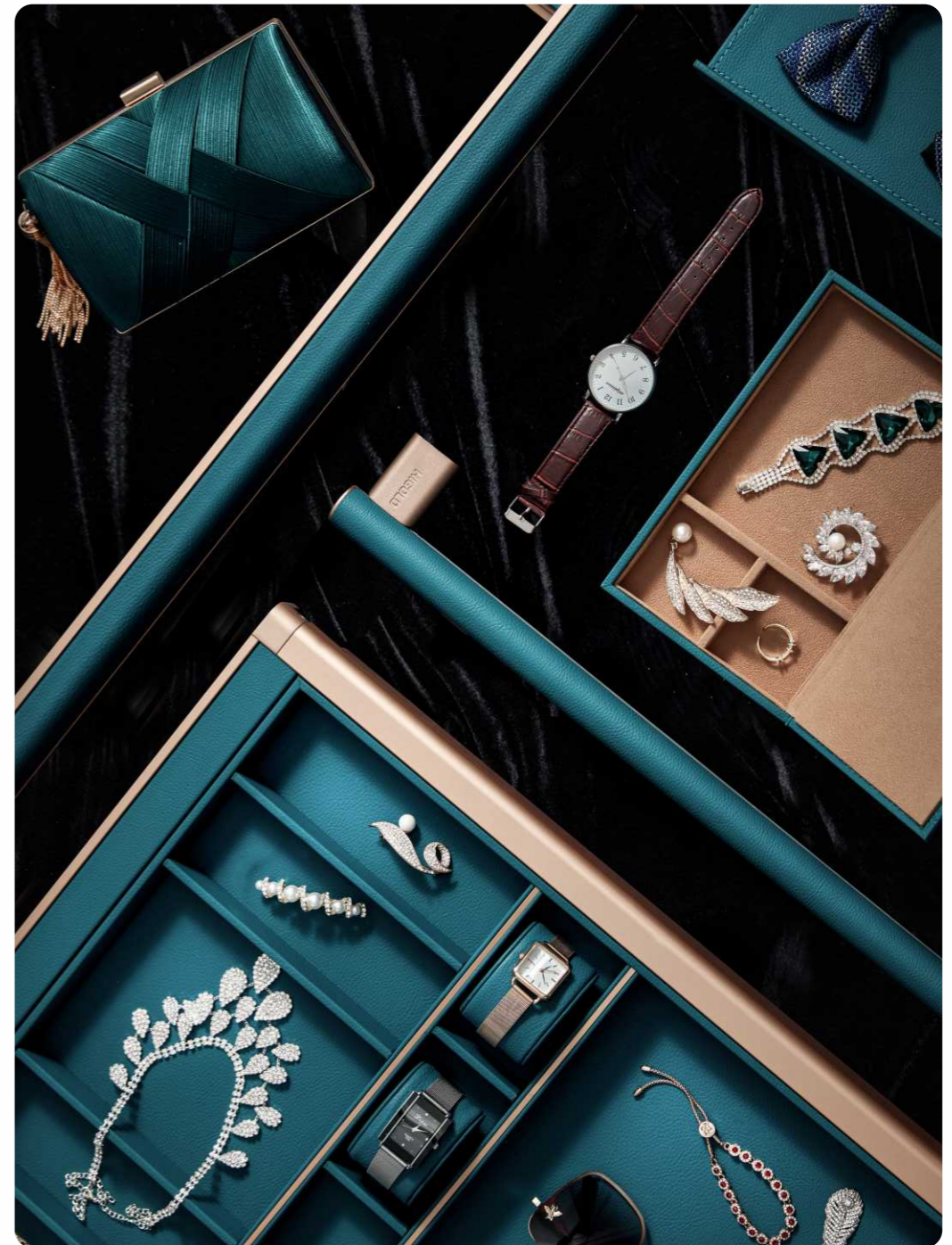

ELEGANT AND MODERN

Use artistic colors to interpret the fashion style of urban upstarts,
continuing elegance and respect.



B SERIES PREMIUM GRAY

Looking at every glamorous work of art,
it creates a golden sense of luxury from the gray system.

B SERIES MORAN GREEN

Like a blonde in a green woolen coat, walking slowly from an oil painting

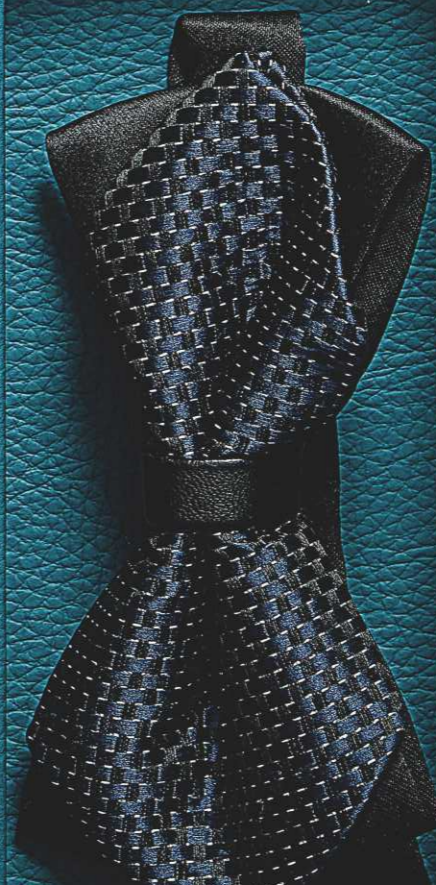



B SERIES

Wardrobe Upstart.
Full-body Leather Art Customization



B SERIES

MORAN GREEN ACCESSORIES STORAGE BOX

Earrings, jewelry, and hair accessories are stored in a basket. Every time, it's like opening a treasure box, slowly choosing the jewelry that fits the day's dress, and traveling shinningly.



MORAN GREEN MULTI-FUNCTIONAL STORAGE BOX

Store small items in order to keep warm from the cold, and you can take them as you need them when the season changes.



MORAN GREEN UNDERWEAR STORAGE BOX

Private clothing should be treated with care. Be purely restrained and release elegance, in the most intimate family space.





MORAN GREEN
DEEP LEATHER BASKET

Thick coats and bedding in winter donot take up closet space.



MORAN GREEN
SHALLOW LEATHER BASKET

Summer thin silk scarves and smallvests are stored uniformly, so you aren't afraid of losing them when you bid farewell to the mess.



MORAN GREEN TIE RACK

Hanging storage avoids zoubaba travel;
avariety of styles are intuitive and easy to matchbefore going to work.



TROUSERS RACK

MORAN GREEN

The belt storage compartment is newly added which is neatly stored and can be taken as needed.

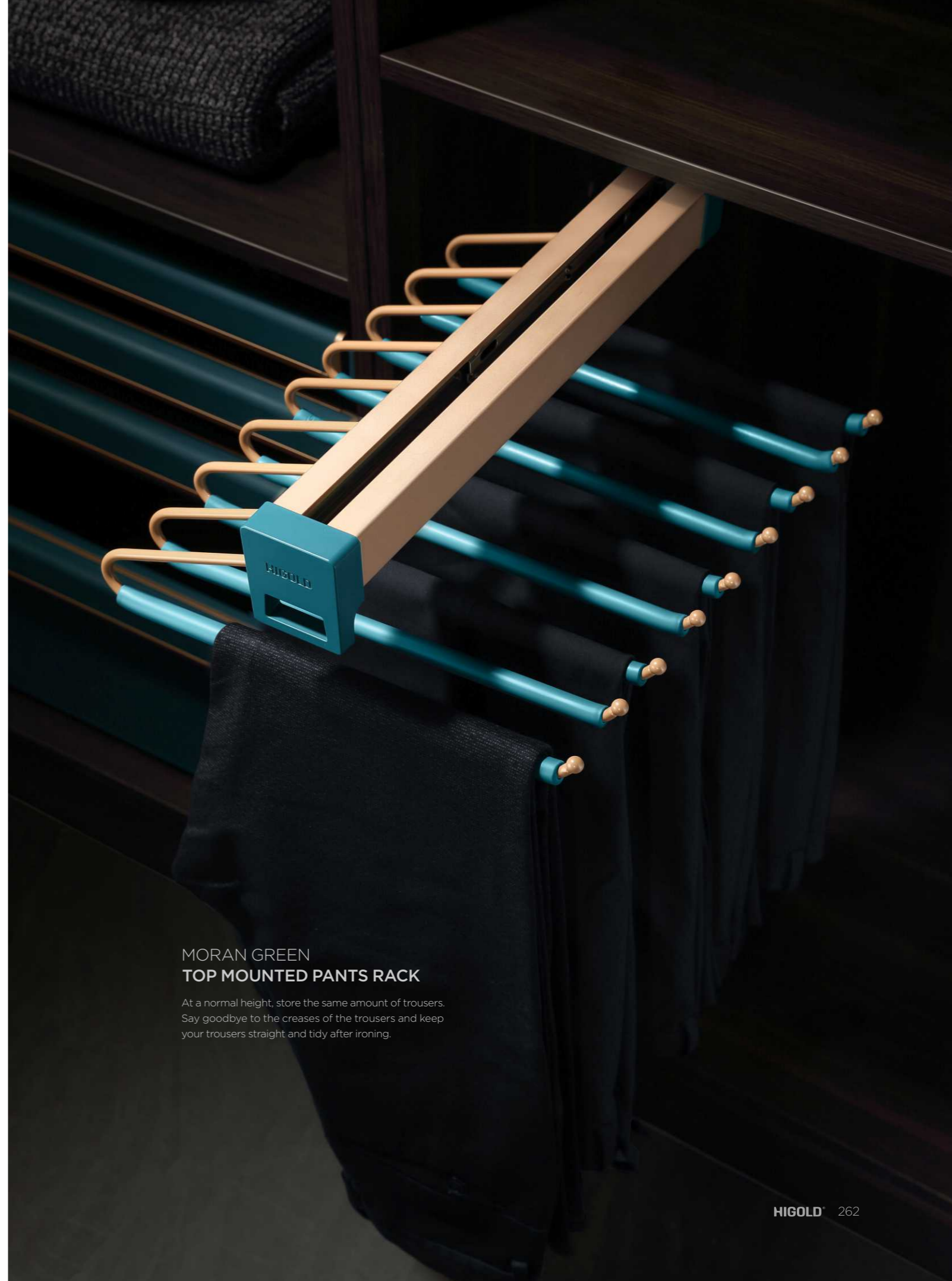

MORAN GREEN TOP MOUNTED PANTS RACK

At a normal height, store the same amount of trousers. Say goodbye to the creases of the trousers and keep your trousers straight and tidy after ironing.



HANG GARMENT LEVER

MORAN GREEN

Match your favorite dresses with gorgeous garment lever.
Add elegance to your wardrobe.

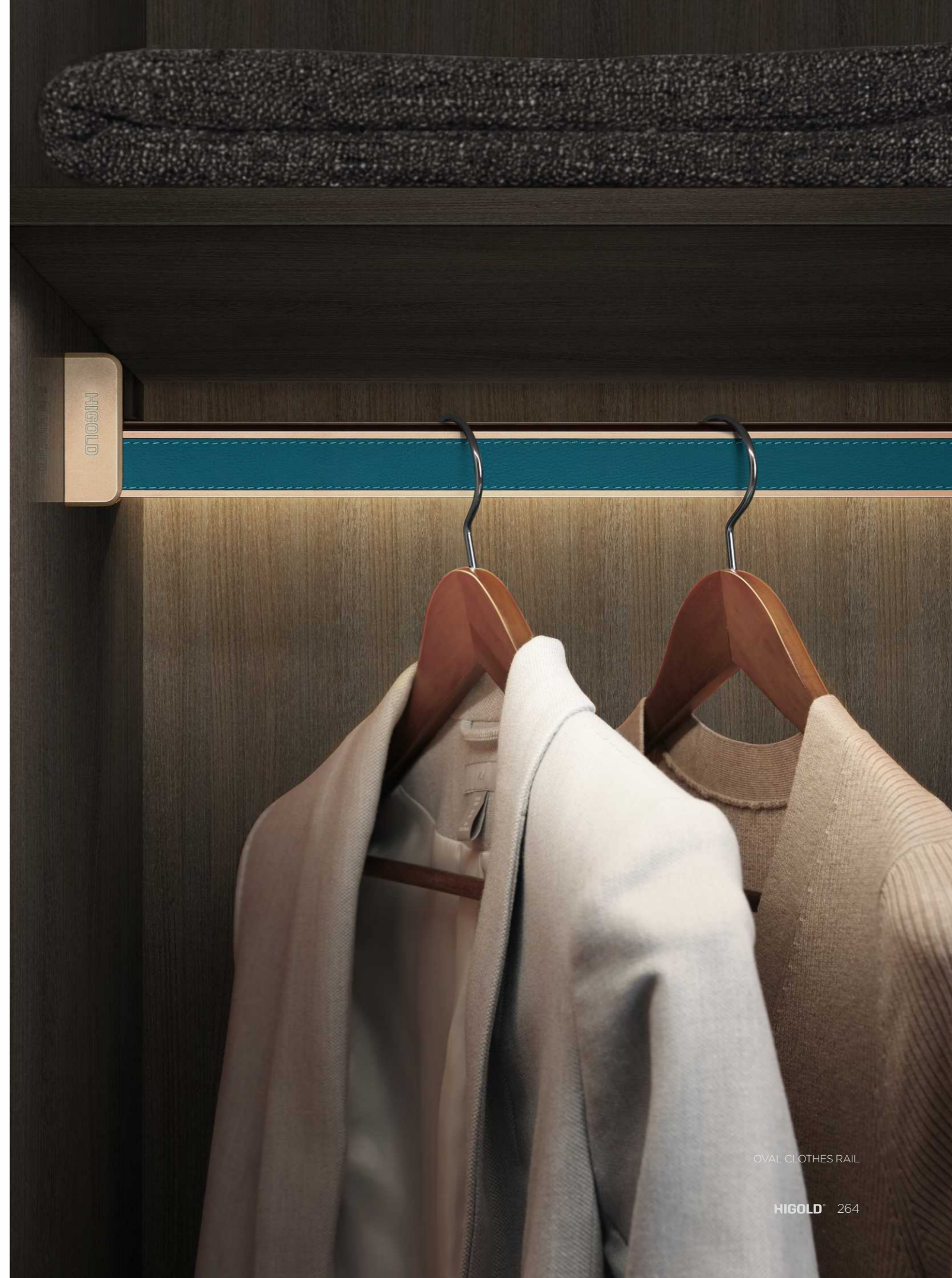



**MORAN GREEN
CLOTHING LIFTING RACK**

Particularly suitable for large wardrobes,
you can hold it no matter how high.



**MORAN GREEN
FULL-LENGTH MIRROR**

The height of 169cm clearly shows the overall
matching effect of each small accessory
on the body.





**MORAN GREEN
ROTATING SHOE RACK**

360° all-round turn-in design, Take put shoes and selection becomes easy, elegant and easy.



**MORAN GREEN
O-SHAPED CORNER CLOTHES RACK**

The difficult problem of traditional wardrobe corners is solved. The longitudinal space is cut into three layers of available positions for large capacity storage bags, clothes, leather cases, etc.

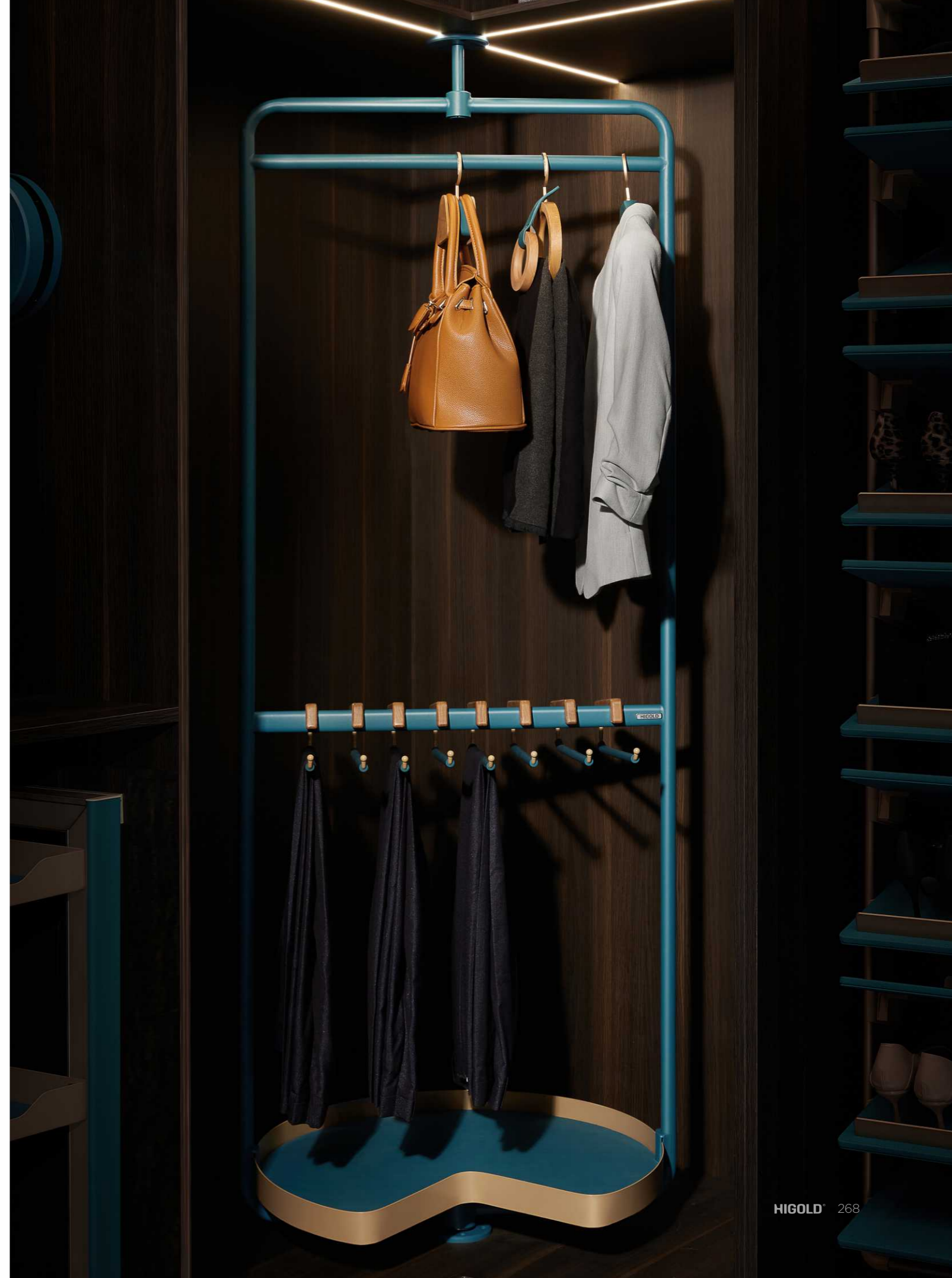

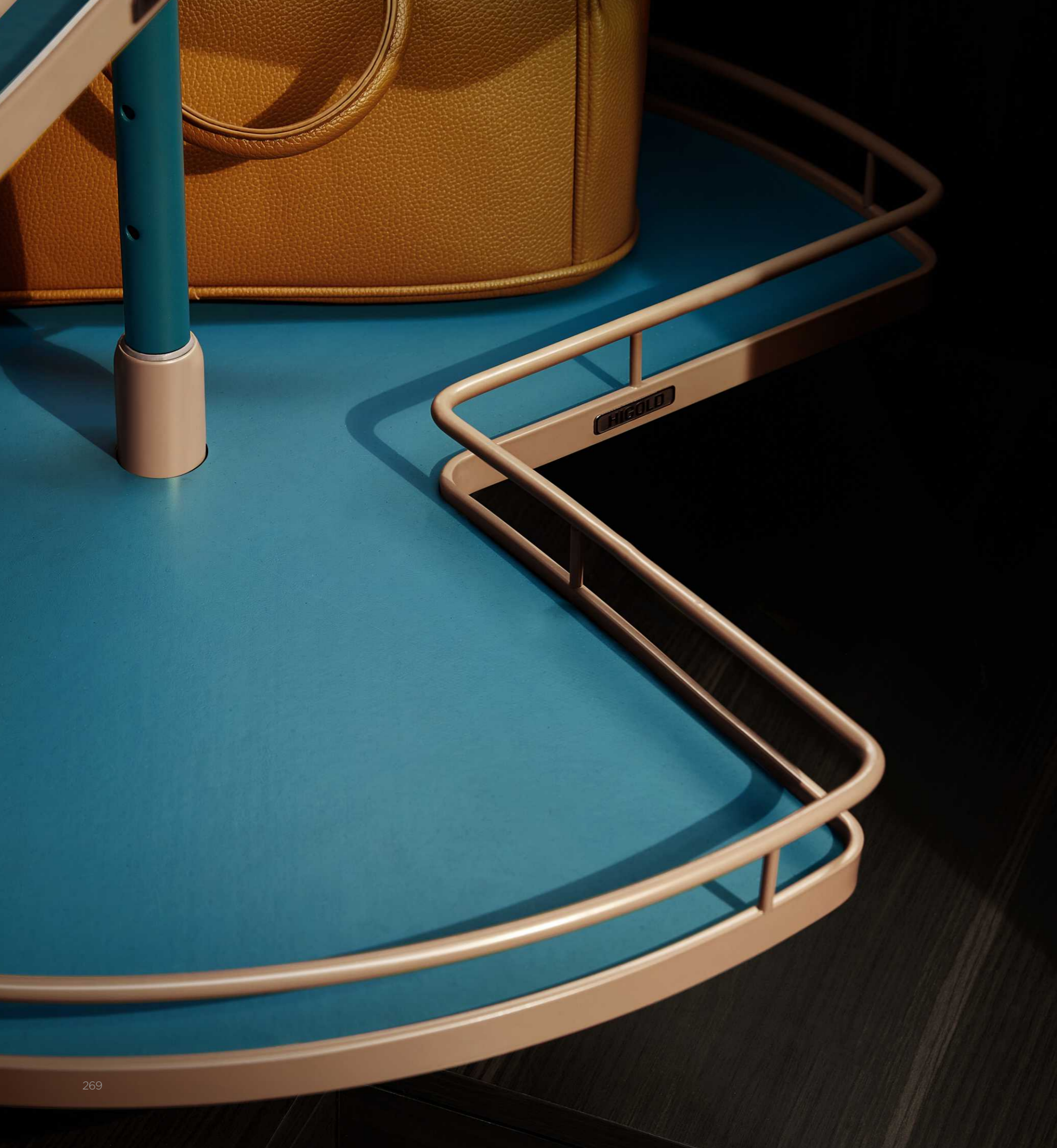

THREE LAYERS CAROUSEL

MORAN GREEN

Designed for corners, 360° rotating design,
objects can be easily retrieved no matter how deep they are hidden.





MORAN GREEN SIDE MOUNT

Side-pull out, clear at a glance, easy to take. Precise guide rail design gives you weightless experience, elegance exists between pushing and pulling.





WOODEN CLOTHES HANGER

MORAN GREEN

All kinds of wooden clothes hangers can meet the needs of modern family wardrobes to store clothes, and the clothes accessories are neat and orderly, and it is more considered to solve the problem of picking and hanging clothes.



MORAN GREEN STEEL SAFE

Fingerprint unlocking, no longer worry about losing precious watches and jewelry, and protect precious things privately.



MORAN GREEN WATCH WINDER

The watch shaker is equipped with a micro motor, which drives the small dial to rotate slowly. The mechanical watch is placed in the dial to achieve the effect of automatic winding, which can prevent the mechanical watch from stopping when the mechanical watch is idle for a long time due to insufficient exercise.



ACCESSORIES STORAGE BOX

Patent NO.: ZL202030714465.X
 Patent NO.: ZL202030714559.7
 Patent NO.: ZL202120623138.2

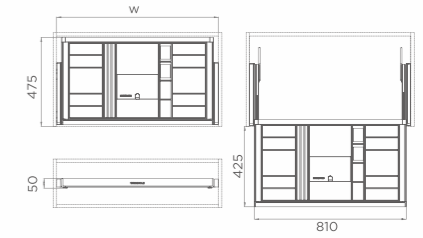
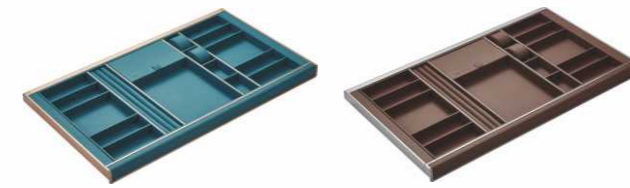

ART. NO (Moran Green)	ART. NO (Premium Gray)	CABINET	W x D x H	REMARK
706041M	706041S	600MM	564x475x50mm	soft close
706042M	706042S	700MM	664x475x50mm	
706043M	706043S	800MM	764x475x50mm	
706044M	706044S	900MM	864x475x50mm	

MULTI-FUNCTIONAL STORAGE BOX

Patent NO.: ZL202030714559.7
 Patent NO.: ZL202120623138.2

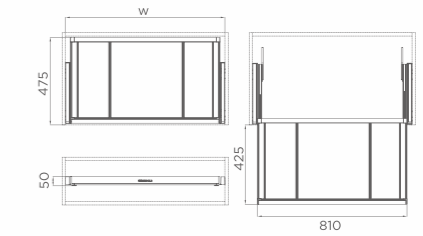
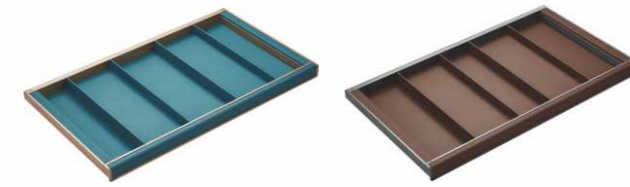

ART. NO (Moran Green)	ART. NO (Premium Gray)	CABINET	W x D x H	REMARK
706001M	706001S	600MM	564x475x50mm	soft close
706002M	706002S	700MM	664x475x50mm	
706003M	706003S	800MM	764x475x50mm	
706004M	706004S	900MM	864x475x50mm	

UNDERWEAR STORAGE BOX

Patent NO.: ZL202030714492.7
 Patent NO.: ZL202030714559.7
 Patent NO.: ZL202120623138.2

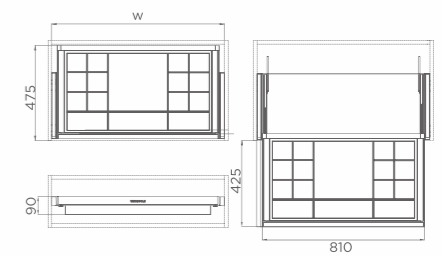
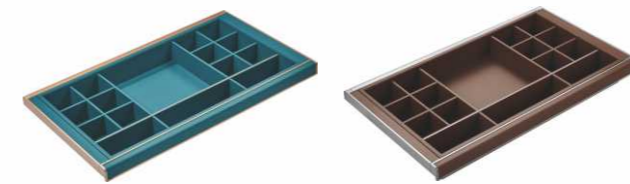

ART. NO (Moran Green)	ART. NO (Premium Gray)	CABINET	W x D x H	REMARK
706011M	706011S	600MM	564x475x90mm	soft close
706012M	706012S	700MM	664x475x90mm	
706013M	706013S	800MM	764x475x90mm	
706014M	706014S	900MM	864x475x90mm	

DEEP LEATHER BASKET

Patent NO.: ZL202030714559.7
Patent NO.: ZL202120623138.2

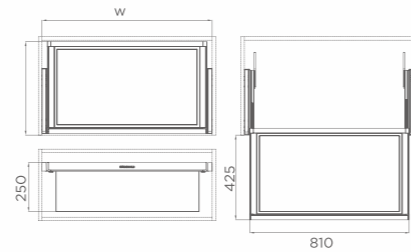
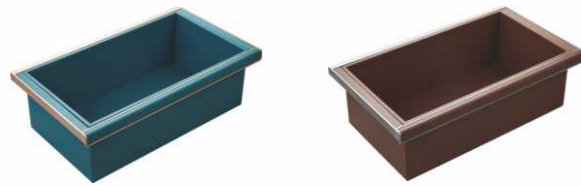

ART. NO (Moran Green)	ART. NO (Premium Gray)	CABINET	W x D x H	REMARK
706051M	706051S	600MM	564x475x250mm	soft close
706052M	706052S	700MM	664x475x250mm	
706053M	706053S	800MM	764x475x250mm	
706054M	706054S	900MM	864x475x250mm	

SHALLOW LEATHER BASKET

Patent NO.: ZL202030714559.7
Patent NO.: ZL202120623138.2

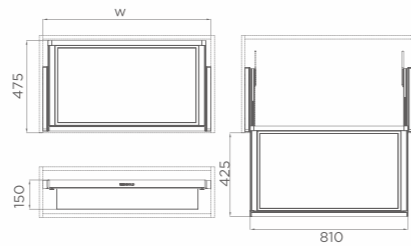
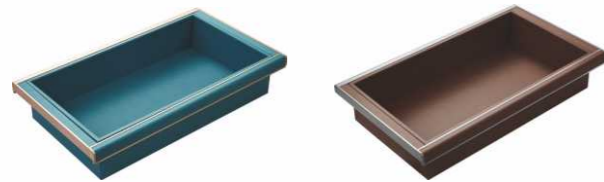

ART. NO (Moran Green)	ART. NO (Premium Gray)	CABINET	W x D x H	REMARK
706031M	706031S	600MM	564x475x150mm	soft close
706032M	706032S	700MM	664x475x150mm	
706033M	706033S	800MM	764x475x150mm	
706034M	706034S	900MM	864x475x150mm	

TROUSERS RACK

Patent NO.: ZL202030717074.3
Patent NO.: ZL202030714559.7
Patent NO.: ZL202120623138.2

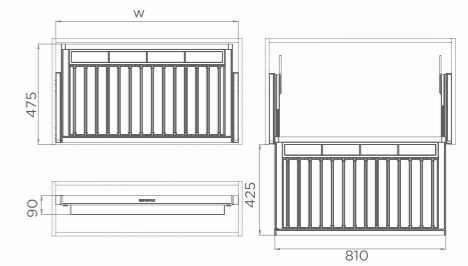
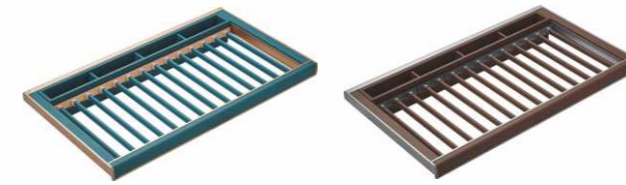

ART. NO (Moran Green)	ART. NO (Premium Gray)	CABINET	W x D x H	REMARK
706021M	706021S	600MM	564x475x90mm	soft close
706022M	706022S	700MM	664x475x90mm	
706023M	706023S	800MM	764x475x90mm	
706024M	706024S	900MM	864x475x90mm	

TOP MOUNTED PANTS RACK

Patent NO.: ZL201930264233.6

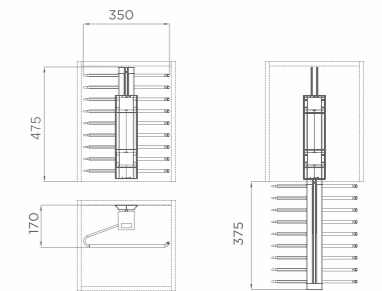

ART. NO (Moran Green)	ART. NO (Premium Gray)	CABINET	W x D x H	REMARK
703502M	703502S	≥ 400MM	350x475x170mm	soft close

ROTATING SHOE RACK

Patent NO. : ZL201930264676.5
 Patent NO. : ZL202122543108.3
 Patent NO. : ZL202220767539.X



ART. NO (Moran Green)	ART. NO (Premium Gray)	CABINET	W x D x H	REMARK
703591M	703591S	≥ 800MM	685x370x(1910-2110)mm	12 layers
703592M	703592S	≥ 800MM	685x370x(1630-1830)mm	10 layers
703593M	703593S	≥ 800MM	685x370x(1350-1550)mm	8 layers
703594M	703594S	≥ 800MM	685x370x(1070-1270)mm	6 layers
703595M	703595S	≥ 800MM	685x370x(790-990)mm	4 layers

O - SHAPED CORNER CLOTHES RACK

Patent NO. : ZL202130362804.7
 Patent NO. : ZL202122547976.9



ART. NO (Moran Green)	ART. NO (Premium Gray)	CABINET	W x D x H	REMARK
706202M	706202S	≥ 800MM	φ 700x(1900-2100)mm	/

SIDE MOUNTED BASKET

Patent NO. : ZL201930264242.5



ART. NO (Moran Green)	ART. NO (Premium Gray)	CABINET	W x D x H	REMARK
703573M	703573S	≥ 400MM	360x475x795mm	left opening / soft close
703574M	703574S	≥ 400MM	360x475x795mm	right opening / soft close

FULL-LENGTH MIRROR

Patent NO. : ZL202030715715.1



ART. NO (Moran Green)	ART. NO (Premium Gray)	CABINET	W x D x H	REMARK
706161M	706161S	1700MM	400x55x1700mm	/

B / SERIES

STEEL SAFE

Patent NO.: ZL202230193249.4



ART. NO (Moran Green)	ART. NO (Premium Gray)	CABINET	W x D x H	REMARK
703297M	703297 S	≥ 490MM	450x425x205mm	/

B / SERIES

WATCH WINDER

Patent NO.: ZL202230193029.1



ART. NO (Moran Green)	ART. NO (Premium Gray)	W x D x H	REMARK
706154M	706154S	410x300x205mm	/

CLOTHING LIFTING RACK



ART. NO (Moran Green)	ART. NO (Premium Gray)	CABINET	W x D x H	REMARK
703156M	703156S	900-1100mm	(864-1064)x500x830mm	soft close

WOODEN CLOTHES HANGER

ART. NO
(Moran Green)
706111M



ART. NO
(Premium Gray)
706111S

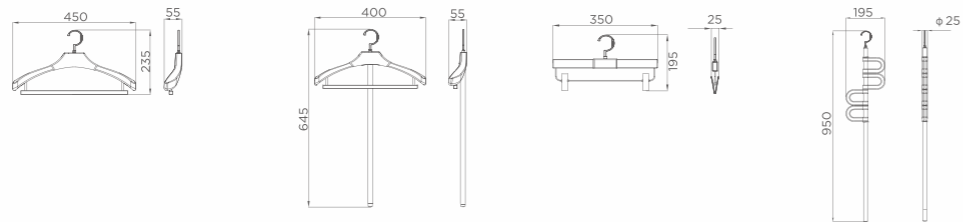

NAME	Clothes and pants hanger	Suit hanger	Pants hangers	Scarf hanger
------	--------------------------	-------------	---------------	--------------

W x D x H	450x55x235mm	400x55x645mm	350x25x195mm	195x25x950mm
-----------	--------------	--------------	--------------	--------------

WOODEN CLOTHES HANGER

ART. NO
(Moran Green)
706111M



ART. NO
(Premium Gray)
706111S

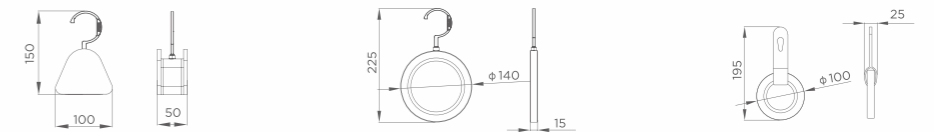

NAME	Bag hanger	Large scarf hanging loop	Small scarf hanging loop
------	------------	--------------------------	--------------------------

W x D x H	100x50x150mm	140x15x225mm	100x25x195mm
-----------	--------------	--------------	--------------

B / SERIES

OVAL CLOTHES RAIL

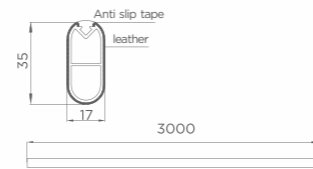

ART. NO (Moran Green)	ART. NO (Premium Gray)	CABINET	W x D x H	REMARK
706191M	706191S	3000MM	3000x17x35mm	Top mounting / Side mounting

HANGING ROD HOLDERS

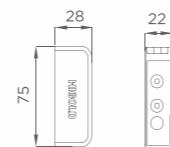

ART. NO (Moran Green)	ART. NO (Premium Gray)	W x D x H	REMARK
703660M	703660S	28x22x75mm	Top mounting / Side mounting Aluminum alloy

TIE RACK



ART. NO (Moran Green)	ART. NO (Premium Gray)	W x D x H	REMARK
703541M	703541S	85x435x95mm	/

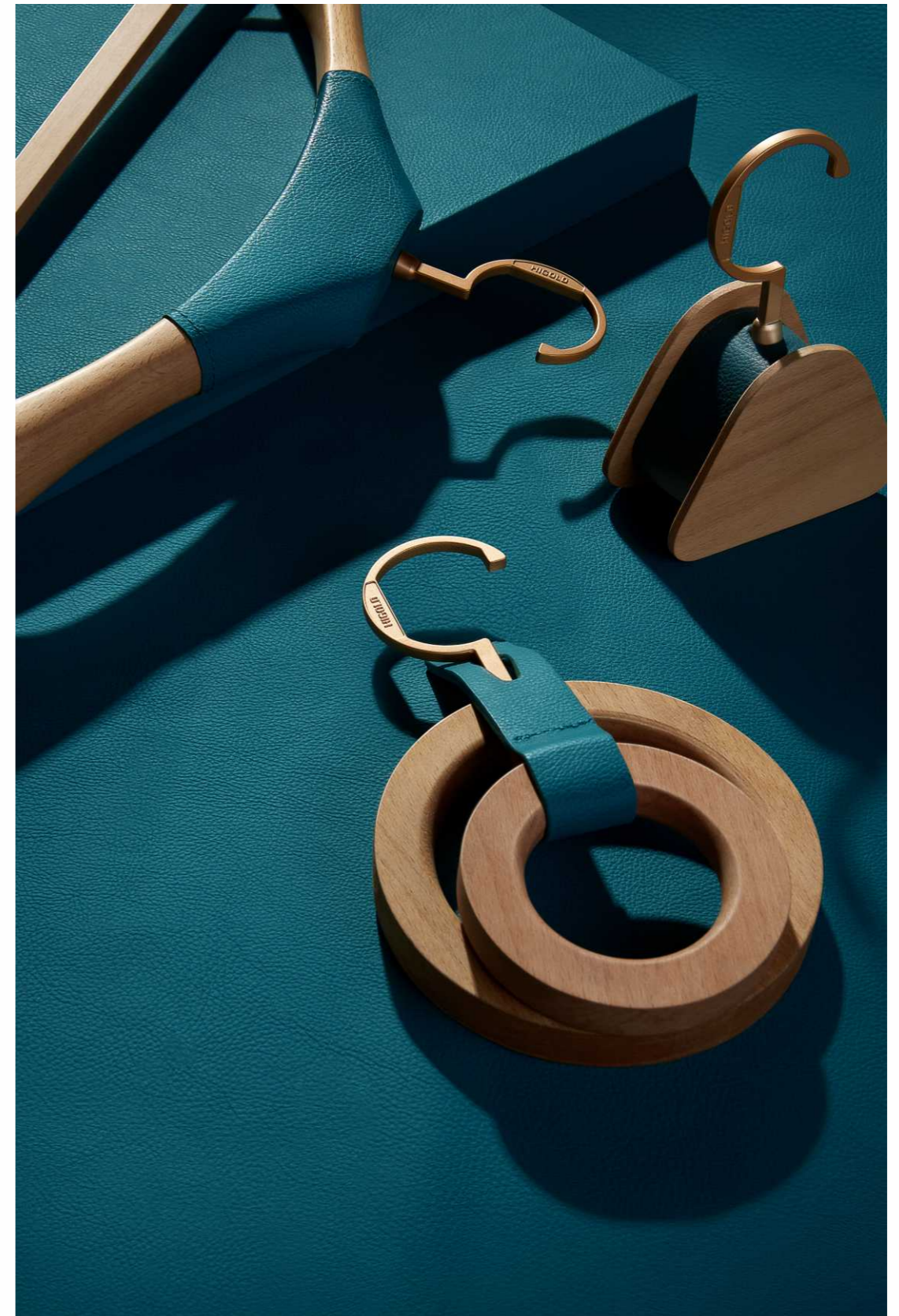

B 2.0 SERIES

Elegant and socialite style
Ultimate luxury feeling
Performing Elegant Art





B2.0 SERIES
ELEGANCE



B2.0 SERIES

The BV 2.0 wardrobe storage system, since its creation, has given life the most sincere respect, appreciation, and care. With unique warmth and beauty, it perfectly blends luxurious leather and dazzling metal, bringing extraordinary innovation to private storage in a noble form.

Light and shadow flow, thousands of pink and Daisy flowers bloom freely; Perfectly beautiful, private storage pleasing to the eye. The beauty area, display area, stacking area, and pants hanging area are breathtaking, and the wardrobe space flows smoothly and gracefully; The ingenious storage foundation achieves a perfect balance between aesthetic structure and functionalism, making every smile and frown both calm and luxurious.





BEAUTY STORAGE BOX

Add beauty storage to meet more practicality

A perfect creation that leads the times, the "storage + beauty" functional partition is ingeniously designed. Makeup and skin care tools are all in their own place, making it an epoch-making piece of beauty storage.





ACCESSORIES STORAGE BOX

Italian design, life aesthetics

Cleverly embellished with metallic lines and paired with delicate and rich textured leather, accessing accessories is well-organized and as bright as stars.





UNDERWEAR STORAGE BOX

Skin friendly leather for delicate storage of private items

Create carefully selected items with the heart of nature, respect the original needs, comprehensively protect delicate and thoughtful clothes, and protect a comfortable life.





MULTI-FUNCTIONAL STORAGE BOX

Thickened aluminum alloy, reinforced load

Collect art to make the space relaxed and generous, and treat yourself with luxury in every inch.

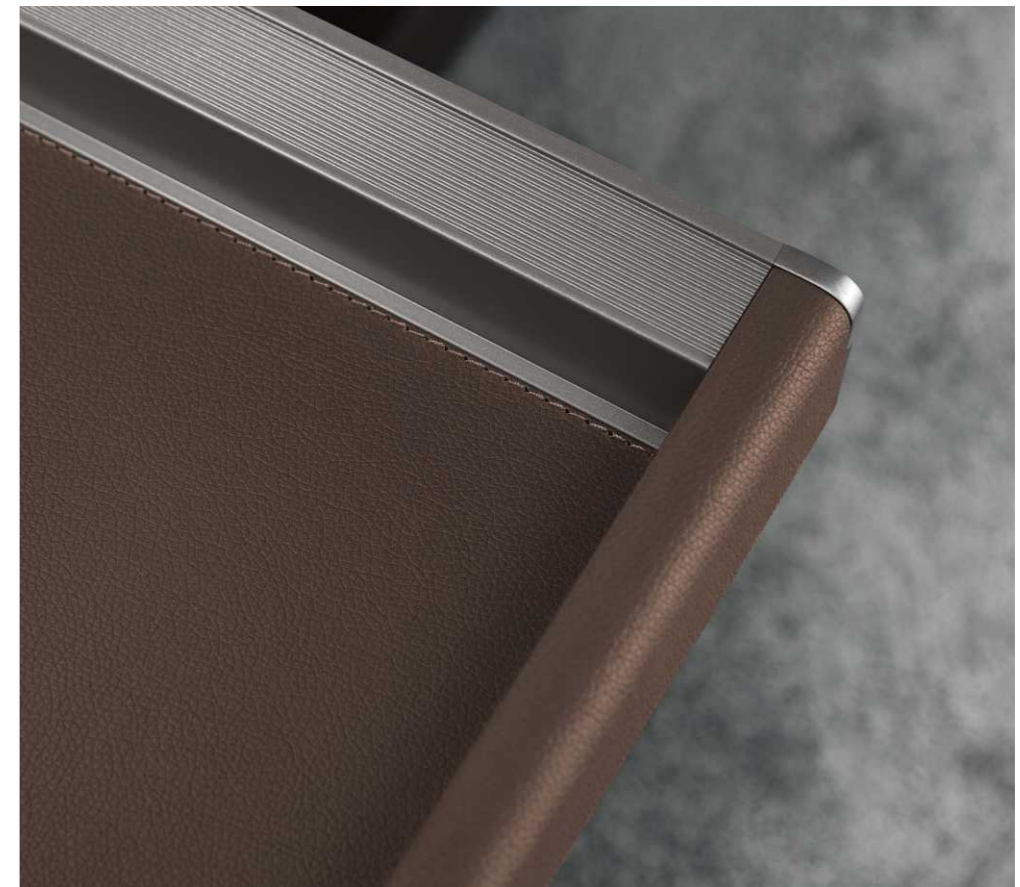



TROUSERS RACK

Soft-closing slide with silent push and pull



Push and pull smoothly and quietly, non-slip and adjustable for easy access.
Luxurious trousers outfit award.



B2.0 SERIES
SHALLOW LEATHER BASKET

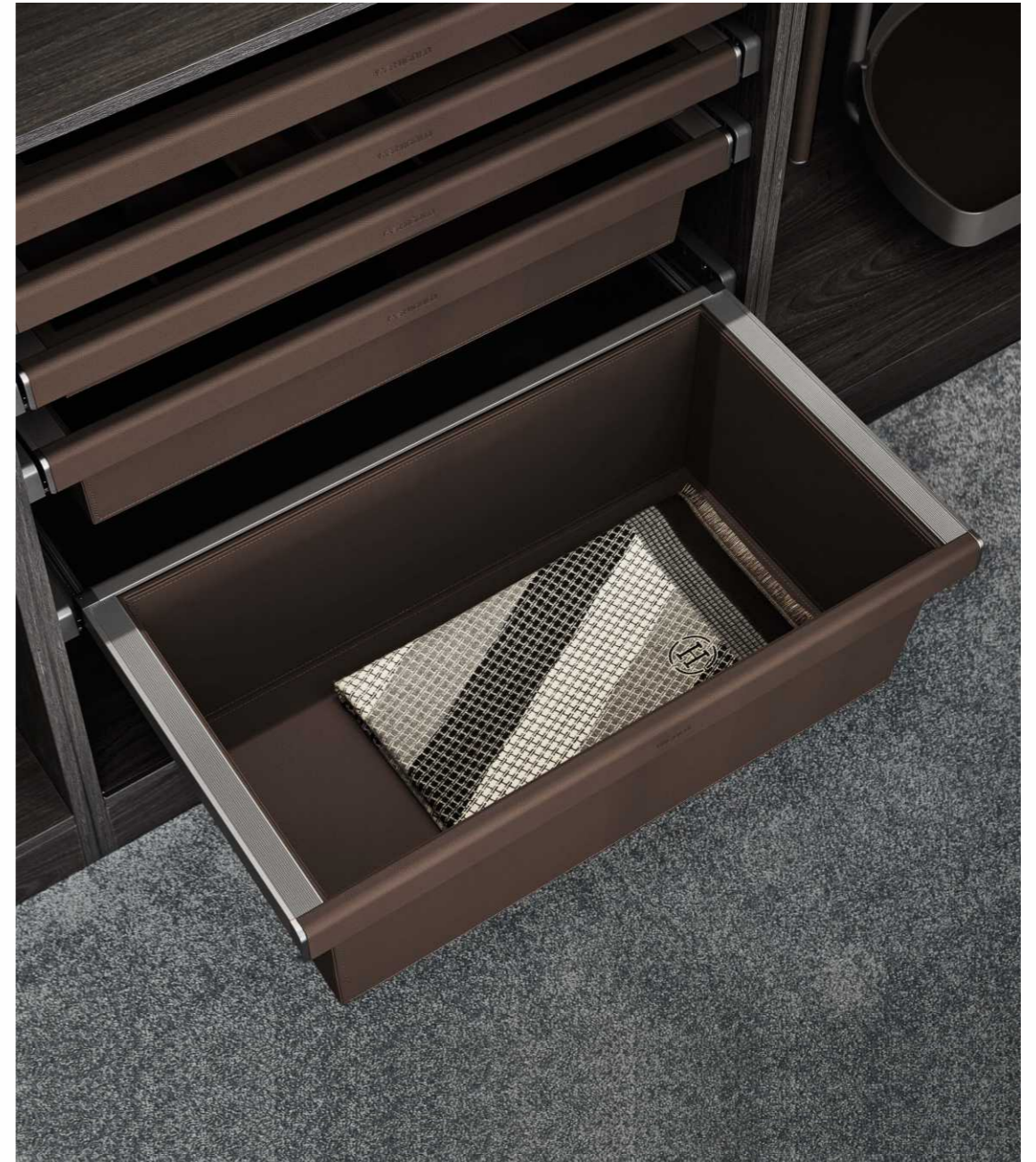

B2.0 SERIES
SHALLOW LEATHER BASKET

Thick clothes are carefully placed, deep leather basket can carry thousands of favors for your beloved

MULTI-FUNCTIONAL STORAGE BOX



ART. NO (Premium Gray)	CABINET	W x D x H
706301S	600mm	564x475x50mm
706302S	700mm	664x475x50mm
706303S	800mm	764x475x50mm
706304S	900mm	864x475x50mm

BEAUTY STORAGE BOX



ART. NO (Premium Gray)	CABINET	W x D x H
706361S	600mm	564x475x50mm
706362S	700mm	664x475x50mm
706363S	800mm	764x475x50mm
706364S	900mm	864x475x50mm

SHALLOW LEATHER BASKET



ART. NO (Premium Gray)	CABINET	W x D x H
706331S	600mm	564x475x160mm
706332S	700mm	664x475x160mm
706333S	800mm	764x475x160mm
706334S	900mm	864x475x160mm

ACCESSORIES STORAGE BOX



ART. NO (Premium Gray)	CABINET	W x D x H
706341S	600mm	564x475x50mm
706342S	700mm	664x475x50mm
706343S	800mm	764x475x50mm
706344S	900mm	864x475x50mm

DEEP LEATHER BASKET



ART. NO (Premium Gray)	CABINET	W x D x H
706351S	600mm	564x475x260mm
706352S	700mm	664x475x260mm
706353S	800mm	764x475x260mm
706354S	900mm	864x475x260mm

UNDERWEAR STORAGE BOX



ART. NO (Premium Gray)	CABINET	W x D x H
706311S	600mm	564x475x90mm
706312S	700mm	664x475x90mm
706313S	800mm	764x475x90mm
706314S	900mm	864x475x90mm

TROUSERS RACK



ART. NO (Premium Gray)	CABINET	W x D x H
706321S	600mm	564x475x50mm
706322S	700mm	664x475x50mm
706323S	800mm	764x475x50mm
706324S	900mm	864x475x50mm



A SERIES ADVANCED UNITS

Use artistic colors to interpret the fashion style of urban upstarts,
continuing elegance and respect.





DEEP LEATHER BASKET - A SERIES



UNDERWEAR STORAGE BOX - A SERIES



ACCESSORIES STORAGE BOX - A SERIES



MULTIFUNCTIONAL STORAGE BOX - A SERIES



PANT RACK
PREMIUM GRAY

Adopt grab type to hang, enlarge not only receive a space, and take convenient.
Thick hanging strip design, pants not easy to slip, not easy to crease,
Say goodbye to clutter and keep your pants straight and neat after ironing.





**PREMIUM GRAY
CORNER CLOTHES BASKET**

Cut the difficult-to-use high and deep space at the corner into three usable positions, transforming it into a large-capacity space for storing bags, clothing, and suitcases.



**PREMIUM GRAY
ROTATING SHOE RACK**

Designed for corners, 360° rotating design, objects can be easily retrieved no matter how deep they are hidden.





PREMIUM GRAY
SAFE BOX

Three silent slides, draw quiet.
Invisible storage, anti-dirty collision.

PREMIUM GRAY
ROTATING FRAME

Particularly suitable for large wardrobes,
you can hold it no matter how high.



ACCESSORIES STORAGE BOX

Patent NO.: ZL201921241422.2

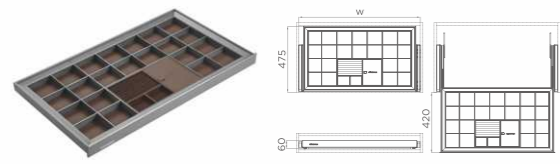

ART. NO (Premium Gray)	CABINET	W x D x H
703741S	600MM	564x475x60mm
703742S	700MM	664x475x60mm
703743S	800MM	764x475x60mm
703744S	900MM	864x475x60mm

UNDERWEAR STORAGE BOX

Patent NO.: ZL201921241422.2

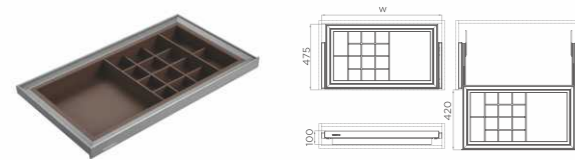

ART. NO (Premium Gray)	CABINET	W x D x H
703711S	600MM	564x475x100mm
703712S	700MM	664x475x100mm
703713S	800MM	764x475x100mm
703714S	900MM	864x475x100mm

DEEP LEATHER BASKET

Patent NO.: ZL201921241422.2

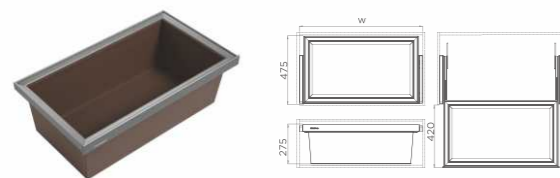

ART. NO (Premium Gray)	CABINET	W x D x H
703731S	600MM	564x475x275mm
703732S	700MM	664x475x275mm
703733S	800MM	764x475x275mm
703734S	900MM	864x475x275mm

TROUSERS RACK

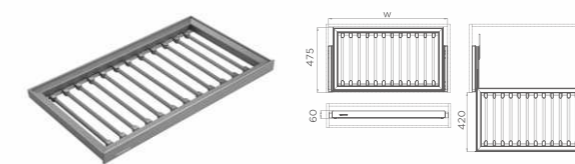

ART. NO (Premium Gray)	CABINET	W x D x H
703721S	600MM	564x475x60mm
703722S	700MM	664x475x60mm
703723S	800MM	764x475x60mm
703724S	900MM	864x475x60mm

SAFE BOX



SENSER TOUCH (COUNTERTOP)

ART. NO (Premium Gray)	W x D x H
703296S	450x405x200mm

SAFE BOX



FINGERPRINT+TOUCH SCREEN+KEY (BUILT-IN)

ART. NO (Premium Gray)	W x D x H
703290	480x400x150mm

FULL-LENGTH MIRROR

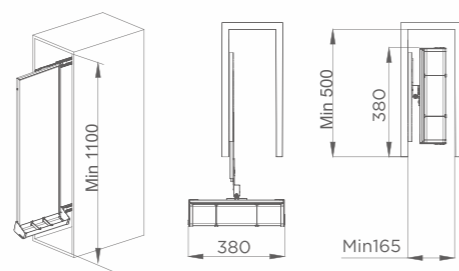
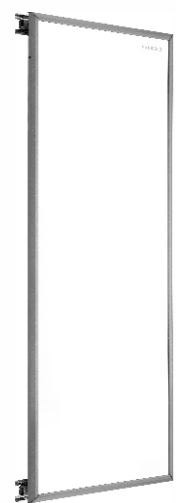

ART. NO (Premium Gray)	CABINET	W x D x H
703565S	≥ 200MM	380x140x1000mm

HANG GARMENT LEVER



ART. NO (Premium Gray)	CABINET	W x D x H
703580S	Socket	25x19x75mm
703581S	Clothes Rail	3000x15x38mm

CORNER CLOTHES BASKET

Patent NO.: ZL201730454891.2

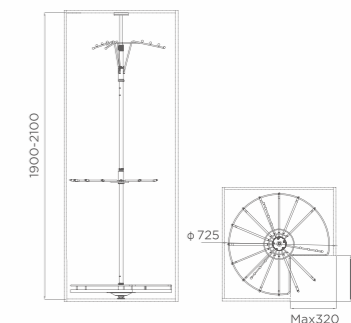

ART. NO (Premium Gray)	CABINET	W x D x H
703552S	≥ 800MM	φ 725x(1900-2100)mm

ROTATING SHOE RACK

Patent NO.: ZL201930264676.5
Patent NO.: ZL202122543108.3
Patent NO.: ZL202220767539.X

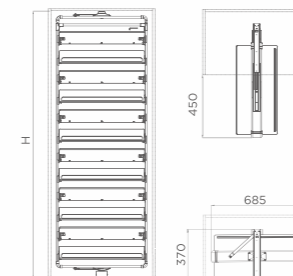

ART. NO (Premium Gray)	CABINET	W x D x H
703691S	≥ 800MM (12 layers)	685x370x(1910-2110)mm
703692S	≥ 800MM (10 layers)	685x370x(1630-1830)mm
703693S	≥ 800MM (8 layers)	685x370x(1350-1550)mm
703694S	≥ 800MM (6 layers)	685x370x(1070-1270)mm
703695S	≥ 800MM (4 layers)	685x370x(790-990)mm

MUSE SERIES

Returning to the simplicity of beauty
It's a new era
The luxury that should be



HIGOLD

MUSE SERIES
MINIMALIST STYLE



MUSE SERIES

The Muse series pursues the "organic" combination of fashion and environmental protection. Under the ingenious conception of the designer, a natural life is achieved. The beauty of extreme simplicity.

The Muse series takes the shape of "felt" and replaces the cold and hard metal texture with softness. It abandons complicated shapes and uses simple frames to create a more agile visual effect and a wider storage space, and reap the relaxation of returning to nature feel.





MUSE SERIES

ACCESSORIES STORAGE BOX

Treasure chest style storage

Let every favorite thing have its own place and leave space for the life you love. The selected thick felt is soft to the touch and gentle on the accessories.



MULTI-FUNCTIONAL STORAGE BOX

Large flat design, leaving no dead space

Large flat design, leaving no dead space, free planning, use. Life is full of love and the storage potential is explored through design.



UNDERWEAR STORAGE BOX

Care for close-fitting and delicate clothing

Clear partitions provide flexible storage, providing a lot of convenience for storing close-fitting clothing.





CLOTHES BASKET

Upgrade capacity , well organized

The capacity of the clothes basket has been upgraded, so large items such as seasonal clothes and thin blankets can be "returned" in an orderly manner, containing all the love of life.





TROUSERS RACK

Pants leave no creases

The width of the trouser rack is adjustable, allowing the trousers to remain crease-free and create an organized style.



ACCESSORIES STORAGE BOX



ART. NO (Premium Gray)	CABINET	W x D x H
706641	600mm	564x480x75mm
706642	700mm	664x480x75mm
706643	800mm	764x480x75mm
706644	900mm	864x480x75mm

MULTI-FUNCTIONAL STORAGE BOX



ART. NO (Premium Gray)	CABINET	W x D x H
706601	600mm	564x480x75mm
706602	700mm	664x480x75mm
706603	800mm	764x480x75mm
706604	900mm	864x480x75mm

UNDERWEAR STORAGE BOX



ART. NO (Premium Gray)	CABINET	W x D x H
706611	600mm	564x480x100mm
706612	700mm	664x480x100mm
706613	800mm	764x480x100mm
706614	900mm	864x480x100mm

CLOTHES BASKET



ART. NO (Premium Gray)	CABINET	W x D x H
706631	600mm	564x480x180mm
706632	700mm	664x480x180mm
706633	800mm	764x480x180mm
706634	900mm	864x480x180mm

TROUSERS RACK



ART. NO (Premium Gray)	CABINET	W x D x H
706621	600mm	564x480x75mm
706622	700mm	664x480x75mm
706623	800mm	764x480x75mm
706624	900mm	864x480x75mm

