

HIGOLD®

Kitchen & Wardrobe Storage Systems

HIGOLD®

Main Board Listed Company
stock code: 001221

HIGOLD GROUP CO.,LTD.

Headquarter Address :
NO.36 Shunye East Rd, Xingtan, Shunde,
Foshan 528325,Guangdong, China

T: + 86 15915802561
T: + 86 15828655891
E: umiwu@higold.com.cn
E: sale31@higold.com.cn
W: www.higoldhardware.com



HIGOLD®

KITCHEN & WARDROBE STORAGE SYSTEMS

[2026]

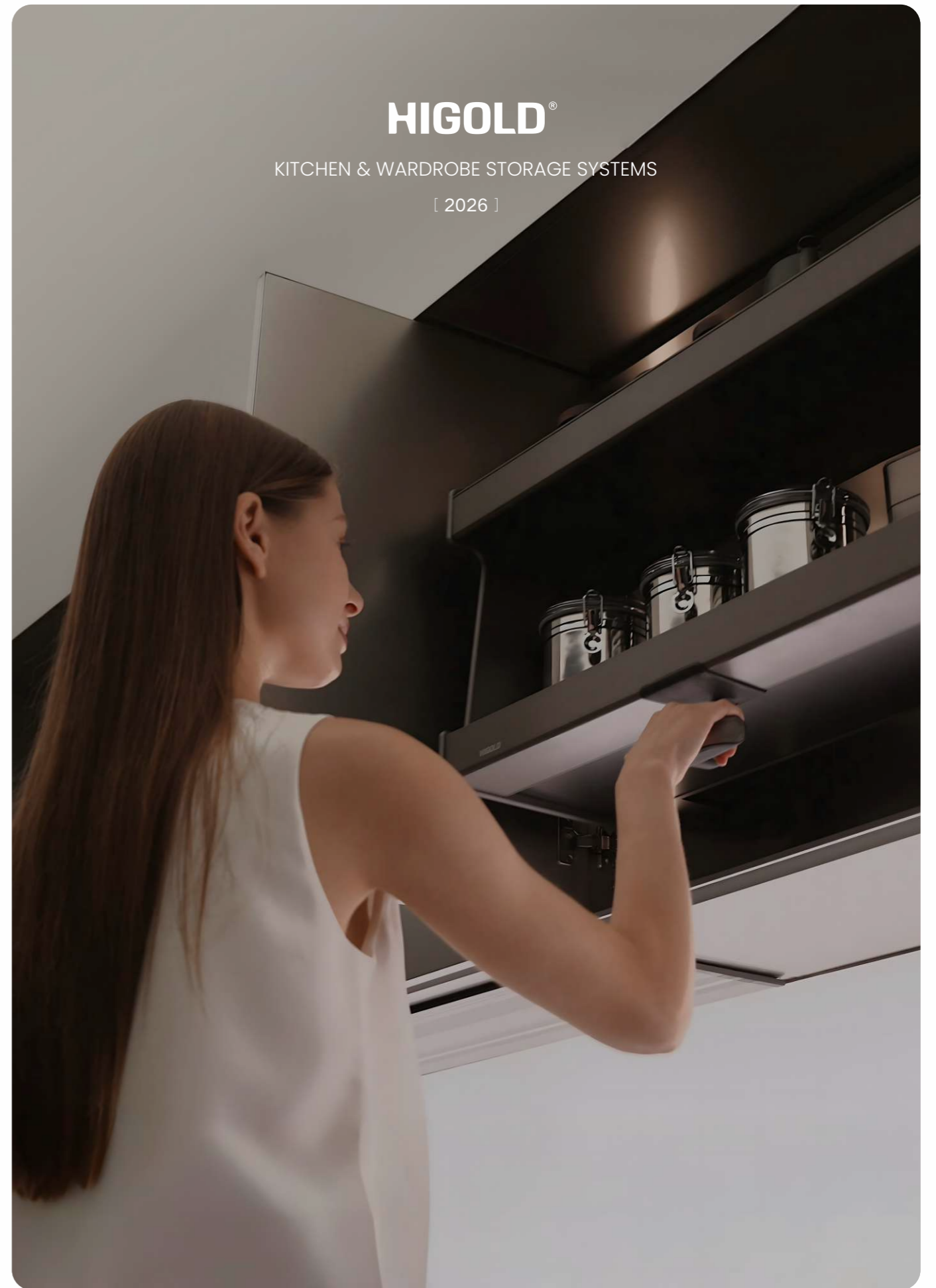

Strive For Improving The Quality Of Human Life



400000^m + 200000^m

400,000 SQM EXISTING
200,000 SQM UNDER CONSTRUCTION

3000⁺

NUMBER OF EXISTING EMPLOYEES

110⁺ 11

COVERING
COUNTRIES/REGIONS

1100⁺

INDEPENDENT
INNOVATION PATENT

8⁺

PRODUCT
CATEGORIES



13 RED DOT
DESIGN AWARDS



17 iF
DESIGN AWARDS

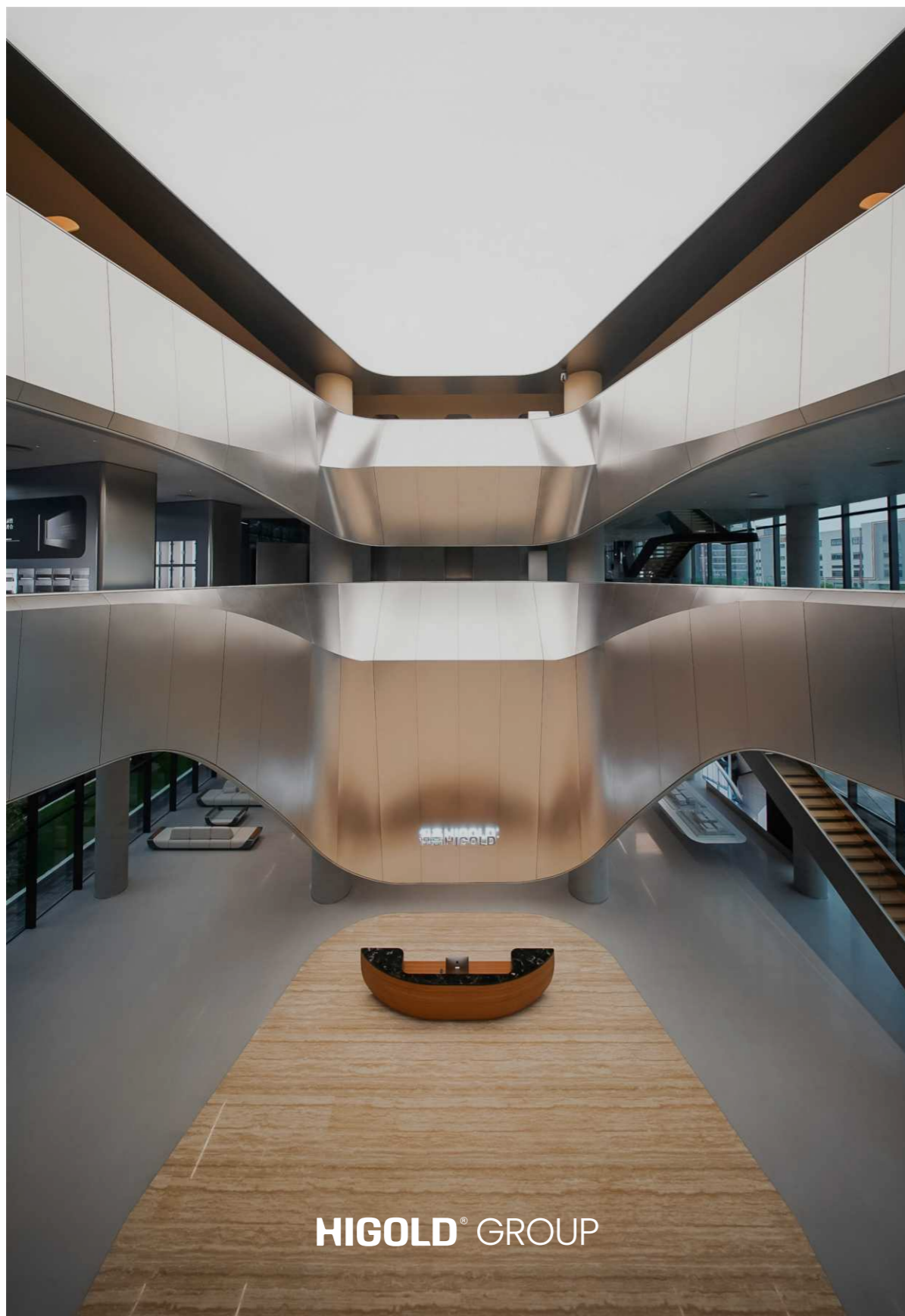

HIGOLD GROUP CO.,LTD.

Higold Group Co., Ltd. Listed company on the Shenzhen Main Board, stock code 001221, founded in 2004, is a diversified and innovative enterprise, focusing on home hardware, business including functional hardware, furniture fittings, kitchen and bathroom hardware, cabinet lighting and outdoor furniture. It is committed to creating one-stop high-end hardware solutions for the whole house for global users. As a middle to high-end brand in China's home hardware industry, its brand awareness and sales scale have always been in a leading position in China. On 30th, July 2025, HIGOLD Group successfully listed on the A-share market, marking the milestone of becoming "the first stock of China's functional hardware" and opening a new chapter in the capital market.

Since its establishment, Higold has always adhered to the strategy of integration of production, research and marketing. It is building a digital production base group of 600,000 square meters in total, mainly with the production base of Higold Star Headquarter, Higold Hexagonal Building and Higold Unicorn Production Base, which is the large-scale intelligent manufacturing base of home hardware in Asia nowadays. With more than 30,000 square meters, Higold Star Headquarters stands in China with the architectural posture of a global original landmark, and its avant-garde, technological, dynamic and fashionable design elements attract much attention. As a national high-tech enterprise, Higold has a strong engineering technology center and research institute. It has long-term strategic cooperation with many top design companies around the world, integrating global high-quality research and innovation resources, so as to provide continuous driving force for "Original Design & Quality".

Up to now, Higold has more than 1100 patents. It is the main drafting unit of the group standard of "Functional Hardware Basket for Home Use" and the drafting unit of the national standard of "Household Kitchen Equipment", Drafting Committee for Group Standard 《General Technical Requirements of LED Cabinet Lighting. Its products have won more than 30 international awards such as the Red Dot Design Award and iF Design Award. In addition, Higold Group was assessed by the Furniture Decoration Industry Branch of China Federation of Industry and Commerce as "Top 10 in Hardware Industry of China's Home Furnishing Manufacturing Industry" and by the China Industry Iconic Brand Committee as "Iconic Brand of China's Home hardware Industry". It was awarded by Guangdong Province Government and Foshan City Government with "Specialized, Precise and Special and New Enterprise of Guangdong Province", "Foshan Top 100 Manufacturing Enterprise" and other honors. HIGOLD has maintained a CAGR (Compound Annual Growth Rate) exceeding 30% over the past three years, solidifying its position as the flagship company in China's household functional hardware industry.

Higold products are sold to over 110 countries and regions in the world, with the sales network covering the whole world. It has hundreds of domestic urban agents and maintains friendly cooperative relations with well-known domestic and foreign enterprises such as OPPEIN, ZBOM, Quanyou, and Germany's Metro. Higold is renowned for its excellent quality and innovative design in the industry. It is committed to building a world-renowned home hardware brand. Higold strives to improve the quality of human life.

Founder & President of the HIGOLD GROUP Mr. Alwin Ou



HIGOLD® STAR HEADQUARTER

Higold Star Headquarters, located in Xingtian High-tech Zone, Shunde, is a landmark building invested by Higold Group and originally designed by Italy's Ferrari Pininfarina design team. With a construction area of about 30,000m², it houses: Higold's R&D Center, Global Sales Center, Customized Home Hardware Museum, Supply Chain Strategic Procurement Center, Ecological Chain Investment Center, Marketing Center, and Multifunctional Conference Facilities.

The Star Headquarters, which took 8 years from design to completion, features a highly creative and futuristic design that embodies Higold's brand DNA and corporate spirit of pursuing excellence and creating legends.

Looking ahead, the Star Headquarters will serve as an incubator for multiple industry-leading "unicorn companies", supporting Higold Group's mission to become a global leader in high-end intelligent manufacturing while shining through diversification. Higold Star Headquarters, with construction area of about 200,000m², is the production base of Higold kitchen hardware, wardrobe hardware, bathroom hardware, decorative hardware, outdoor furniture, committed to building industry 4.0 automation intelligent manufacturing demonstration base.

HIGOLD® HEXAGONAL MANUFACTURING BASE

Higold Group's second intelligent manufacturing base is located in Guanghua Industrial Zone, Xingtian Town, Shunde District, covering a construction area of 200,000 m². Higold Group took the lead in opening a comprehensive digital and intelligent transformation production base of the manufacturing system. The hexagonal manufacturing base, designed as a "Black lights smart factory", will feature: 4 smart factories, 1 R&D center and 1 hardware museum. The core products include hinges, slides, drawers and hardware core components. Currently, it stands as a benchmark demonstration factory, setting industry standards in production efficiency, quality, and innovation.

In the future, it will promote the annual output of hinges to more than 1 billion pieces, and strive to build an unmanned workshop with 24 hours fully automatic production, and strive to become a leading world-class home hardware aircraft carrier.



HIGOLD® UNICORN MANUFACTURING BASE

Higold Unicorn Manufacturing Base is the third intelligent manufacturing base invested and built by Higold Group in Zone B of the Xingtian New Material and Smart Home Industrial Park. Located in the Maicun Industrial Zone of Xingtian, it covers an area of 107.7 acres. In the future, an integrated super factory with a total construction area of over 250,000 m² will be built here. The project is planned to be completed by 2027. In the future, Higold Star Headquarter, Higold Hexagonal Manufacturing Base and Higold Unicorn Manufacturing Base will form a cluster of digital manufacturing bases with a total area of over 600,000 m².

Adhering to the global original architectural concept, this base is still designed by Italy's Pininfarina, embodying the brand's DNA through fluid architectural lines. The entire design style is dynamic, futuristic, and technologically advanced. In the future, this production base will become the main production base for furniture fittings and precision core components, contributing to the Higold Group's accelerated development into a leading world-class home hardware carrier.

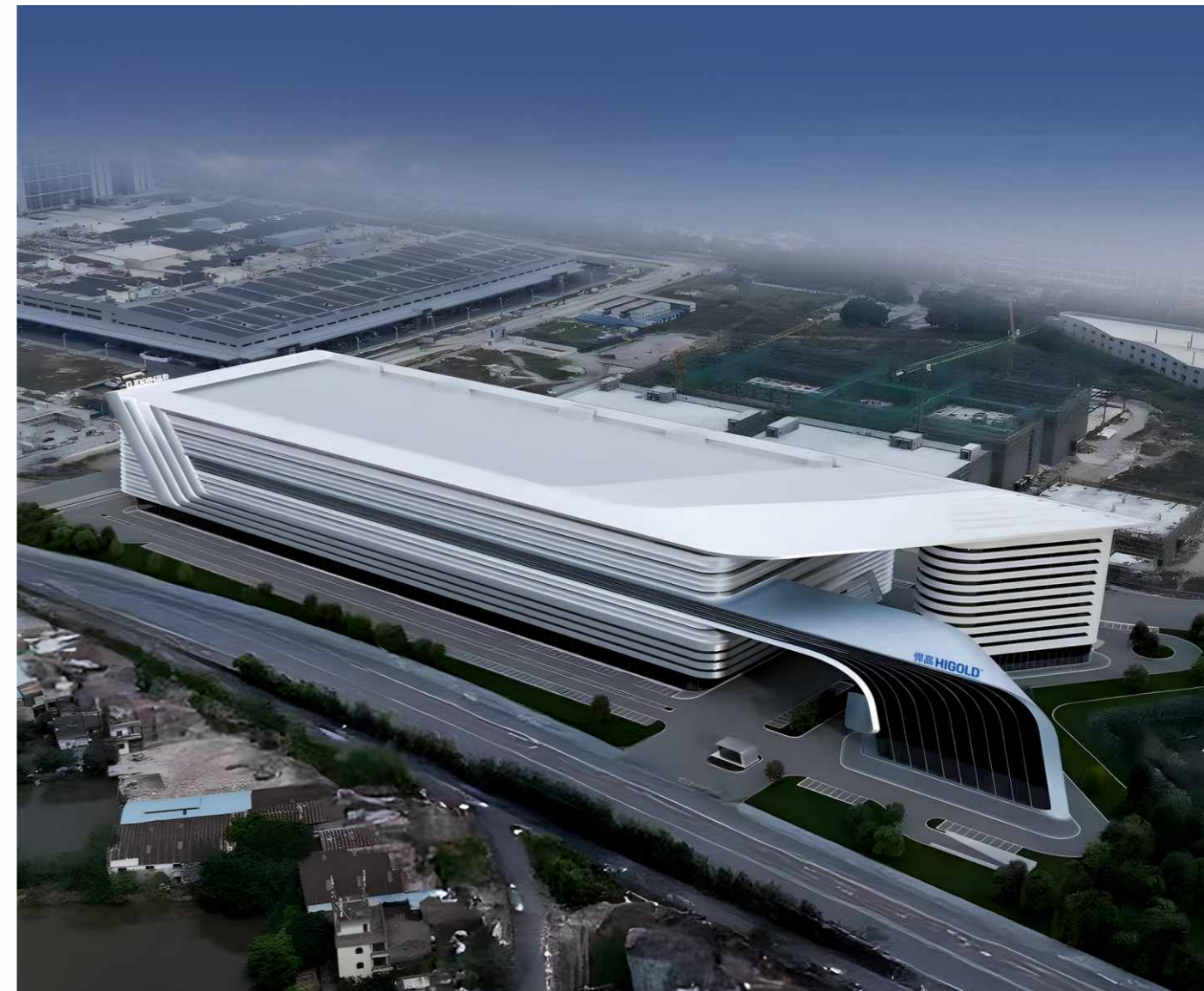

BRAND HISTORY

2004

"Higold" was established to engage in hardware processing and exportation by renting a 1,500 square meters factory in Nanlang, Xingtan town.

The company participated in the Canton Fair for the first time, with a booth area of 9 square meters only.

2006

The production base was relocated to Xingtan East Village, expanded to 15,000 square meters.

2007

The company began to enter the Chinese market.

It transformed from an OEM business to a kitchen functional hardware products business.

To facilitate the registration of trademarks for all product categories, it changed its name from "Kaigao" to "HIGOLD". Considering long-term development, it hired a world-class brand agency to fully upgrade the CI system of the HIGOLD brand. Since then, HIGOLD's independent brand strategy was officially launched.

In the same year, "HIGOLD Outdoor Furniture Company" was established, marking its entry into the outdoor furniture sector and exploration of diversified development.

2008

Survived after the Asian financial crisis, Higold was determined to focus on domestic sales, supplemented by exports, and focus on design and branding as the core of development.

2011

The domestic market strategy has achieved remarkable results, and won the title of "Top 10 kitchen and bathroom accessories enterprises in China".

2012

Awarded Shunde Longteng Enterprise;

Production base expanded to 40,000 square meters;

Products sold to 56 countries and regions around the world; Higold outdoor furniture company participated in SPOGA exhibition in Cologne, Germany for the first time with its own brand, with a booth of 150 square meters.

2013

Higold Kitchenware Company was established, and the product line was extended to kitchen hardware such as sinks and faucets.

2014

Higold was awarded The Red Dot Award with its original design "Space Pantry";

The opening of flagship store of outdoor furniture with an area of 1000m² in Amsterdam, Netherlands;

Higold E-commerce Company was established, and products were sold on e-commerce platforms such as Tmall and JD.com.

2015

Higold brand experience pavilions were set up in 70 cities in China;

Hardware and furniture products were sold to 86 countries worldwide.

The second production base for functional hardware was put into operation.

Higold was awarded National High-tech Enterprise.

Higold was selected as the drafting unit of the national standard of "Household Kitchen Equipment" .

2016

Higold plant in the high-tech zone officially laid the foundation; In the same year, Higold signed contract with Pininfarina in Italy to begin the design of Star Headquarters building.

Advertisements of Higold were displayed in Times Square, New York, USA.

Higold was assigned to be the "Executive President Unit" of China National Hardware Association;

Higold Hardware, which set up agencies over 100 cities in China, indirectly sells products to customers through over 10k authorized kitchen cabinet stores.

2017

Higold built a new production base in Shunde High-tech Zone, with a construction area of nearly 200,000 square meters; Higold Smart kitchenware won the German Red Dot Design Award, which is the second time that Higold won this award; Higold was designated as the main drafting unit of the national standard for "Functional Hardware Basket for Home Use".

2018

The foundation of the Higold Star Headquarters has been officially laid, as the first artwork and landmark building for the Italian Ferrari design team Pininfarina, being in the spotlight.

Higold outdoor furniture gradually extended to outdoor ovens, outdoor umbrellas.

2019

The Chairman of Higold Group, Mr. Alwin Ou, was awarded the title of Advanced Entrepreneur of the New Era" by the government; he was selected as an honorary winner in the "China Home Furnishing Industry Hall of Fame" by China National Furniture Association; Higold's intelligent purification sink, which can solve food safety problems, has been featured in CCTV's programme "Consumer Advocate".

2020

Higold signed the international superstar Donnie Yen as the brand spokesperson, kicking off a journey of strong collaboration; Awarded Manufacturing Single Champion Enterprise in Foshan High-tech Zone; 2020 iF Design Award: Higold outdoor furniture ONDA series.

2021

Higold Group Star headquarters successfully finished the construction; The 101-acre manufacturing base of Higold Hexagonal Building was laid, and the digital super factory of 200,000 square meters was built. Higold Swing Tracy corner unit won the national invention patent, successfully breaking through the technical monopoly of European counter-parts; Higold Shearer hardware series and BN1.0faucet series won the German Red Dot Design Award and the iF Design Award.

2022

Higold Group adjusted the strategic development goal: to become a leading world-class home hardware aircraft carrier.

The No. 1 plant of Higold Hexagonal Building was put into operation smoothly, becoming a leading intelligent manufacturing base for efficiency and scale in the home hardware industry;

Higold product line has gradually developed from partial hardware to whole-house hardware, including functional hardware, furniture fittings, kitchen & bath hardware, cabinet lighting and outdoor furniture in one of the diversified innovative enterprises.

Higold won the "Craftsman Spirit Award 2022";

Higold intelligent sink with automatic cleaning technology won the national invention patent;

Higold BN2.0 faucet and intelligent steam cleaning sink won the 2022 German Red Dot Design Award and iF Design Award.

2023

Higold pull out basket, inner door lock and sink won the 2023 German Red Dot Design Award and iF Design Award respectively;

Higold won the "China Home hardware industry iconic brand", is the only one in the industry;

Higold won four "2023 FT Quality Awards"; and won four "Himalaya Design Award 2023".

2024

Higold Star Headquarters building is fully completed and used, becoming a palace where designers like to check in; Higold auctioned the third production base of 107 acres, to create the third super factory production base, named "unicorn";

Higold launched the people-oriented "Best Employer Program", aiming to build Higold into the most desirable club for outstanding talents;

Higold 1000 square meters of original hardware energy hall to participate in CBD Expo (Guangzhou), the scale is leading in the industry;

The modern factory of Higold Star Headquarters production base and hexagonal building production base has reached 400,000 square meters and nearly 3,000 employees.

"Tourbillon" tall unit cabinet revolving basket won the national invention patent;

Higold Sink, outdoor furniture, beach umbrella, shower head and pull out basket won the 2024 German Red Dot Design Award and iF Design Award respectively.

Alwin Ou, chairman of Higold Group, was awarded the honorary title of "Foshan Enterprise Development Person of the Year 2024" by the government.

2025

Higold Star Headquarters, Muse Wardrobe Storage System, TEKNO R Parasol, Leo sofa and Blade Outdoor Shower won the 2025 German iF Design Award.

Higold Interstellar Headquarters, Muse Wardrobe Storage System won the 2025 Red Dot Award.

On July 30, Higold Group held its IPO listing ceremony for A-shares on the Shenzhen Stock Exchange, officially listing on the Main Board. This milestone establishes its position as "first functional hardware stock in China". Trading under the abbreviation "Higold GROUP" (stock code: 001221), this debut signifies the company's new chapter in the capital market.

DESIGN POWER

HIGOLD®

Designers from Germany, Italy, the United States, France, Australia, Asia and other countries to form a joint design team, these are Higold original aesthetics of the source power.



BRAND HONOR

 **The winner of 2014 Red Dot Award**
Higold SHENZHOU-10 space capsule

 2020 iF Design Award:
"ONDA" Series from HIGOLD Outdoor furniture

 **The winner of 2017 Red Dot Award**
Higold Water Dispens

 2021 iF Design Award: Higold Shearer 4.0 Series

 **The winner of 2018 Red Dot Award**
Higold kitchen intelligent mini oven

 2021 iF Design Award: Higold Piniz faucet

 **The winner of 2021 Red Dot Award**
Higold Shearer 4.0 series

 2022 iF Design Award: Higold's Piniz faucet 2.0

 **The winner of 2022 Red Dot Award**
Higold's Piniz Faucet 2.0

 2022 iF Design Award:
Higold Multifunctional Purification Kitchen Sink

 **The winner of 2022 Red Dot Award**
Higold Multifunctional Purification Kitchen Sink

 2022 iF Design Award: Higold P10 integrated sink dishwasher

 **The winner of 2023 Red Dot Award**
Higold Inner Door Lock F1 Series

 2023 iF Design Award: Higold Built-In Range Hood

 **The winner of 2023 Red Dot Award**
Higold Inner Door Lock F2 Series

 2023 iF Design Award: Higold BL2.0 Multifunction Sink

 **The winner of 2024 Red Dot Award**
Higold Shearer 3.0 Pro Series

 2023 iF Design Award: Higold Tourbillon Rotating Basket

 **The winner of 2024 Red Dot Award**
Higold B2 Series

 2024 iF Design Award: Higold BL3.0 Sink

 **The winner of 2024 Red Dot Award**
Higold TEKNO R Series

 2024 iF Design Award: Armonia series

 **The winner of 2025 Red Dot Award**
Higold Muse Wardrobe Storage System

 2024 iF Design Award: Higold LEVIA series

 **The winner of 2025 Red Dot Award**
Higold Interstellar Headquarters

 2025 iF Design Award: Higold Interstellar Headquarters

 2025 iF Design Award: Higold Muse Wardrobe Storage System

 2025 iF Design Award: Leo Sofa

 2025 iF Design Award: TEKNO R Parasol

 2025 iF Design Award: Blade Outdoor Shower

National high-tech enterprises

ISO14001 environmental management system certification

ISO9001 quality management system certification

Iconic brand of hardware industry

Provincial industrial design center

Provincial Specialized and New Enterprise

Provincial Top 100 e-commerce Enterprise

Selected into the China Household Hall of Fame Enterprise

The top 10 of hardware Industry

Top 500 of China Household Manufacturing Industry

The top 100 Manufacturing Enterprises in Foshan City

 National Standards Maker of Kitchen Hardware Industry

 Functional hardware drawing basket master drafting unit

 National High-Tech Enterprise

 Top ten Chinese enterprises of kitchen and bathroom accessories



Red Star Design Award



Red Star Design Award



kapok
Design Award China



FT Quality Award



Canton Fair Design Award



Canton Fair Design Award



Canton Fair Design Award



HIMALAYA Design Awards



HIMALAYA Design Awards



HIMALAYA Design Awards



The Pinnacle
Awards Asia-pacific



Pininfarina
Co-designing institute



Gloden Hook Prize

MENU

SHEARER SERIES 001

TOURBILLON PANTRY	003
TALL UNIT	009
LIFT BASKET	031
SWING TRAYS 3.0	063
MAGIC CORNER	067
SHEARER 4.0 MAX	075
SHEARER 4.0 PRO	081
SHEARER 4.0	087
SHEARER 3.0 MAX	103
SHEARER 3.0	109
SHEARER 3.0 mini	119
SHEARER 6.0 mini	129
PANDORA 2.0	137
JING RAN	147
SHEARER THREE SIDES	165
SHEARER FOUR SIDES	167
MINI PANTRY	169
NARROW BASKET	171
CAPRI MID WAY SET	173

DIAMOND SERIES 175

TALL UNIT	177
DISH AND BOWL LIET BASKET	185
SWING TRAYS 3.0	187
MAGIC CORNER	191
STARRY BASE UNITS	199
SIDE BASKET	205
DIAMOND 2.0	209

FASHION SERIES 215

TALL UNIT	217
SS DRAINING RACK	221
FOUR SIDE BASKET	223
MAGIC CORNER	225
NARROW BASKET	227
CLEAR-LIQUID RACK	231

PLATINUM SERIES 233

PLATINUM 2.0 BASE UNITS	233
PLATINUM 2.0 PRO BASE UNITS	239
MARTIN 2.0 BASE UNITS	249
M SERIES BASE UNITS	259

WASTEBIN 263

WARDROBE ACCESSORIES 275

B SERIES	281
B 2.0 SERIES	321
A SERIES	343
MUSE SERIES	357

STORAGE SYSTEMS

HIGOLD®

Leading Design
Perfect Experience



KITCHEN

Stylish design and innovative details, combined with large-capacity storage and functional practicability, are a new interpretation of the Higold kitchen storage hardware system. The smooth and smooth opening and closing action makes storage more convenient; the quality from the inside to the outside is strictly controlled to achieve durability. Precision craftsmanship only creates high-quality, cleaner kitchens for users.

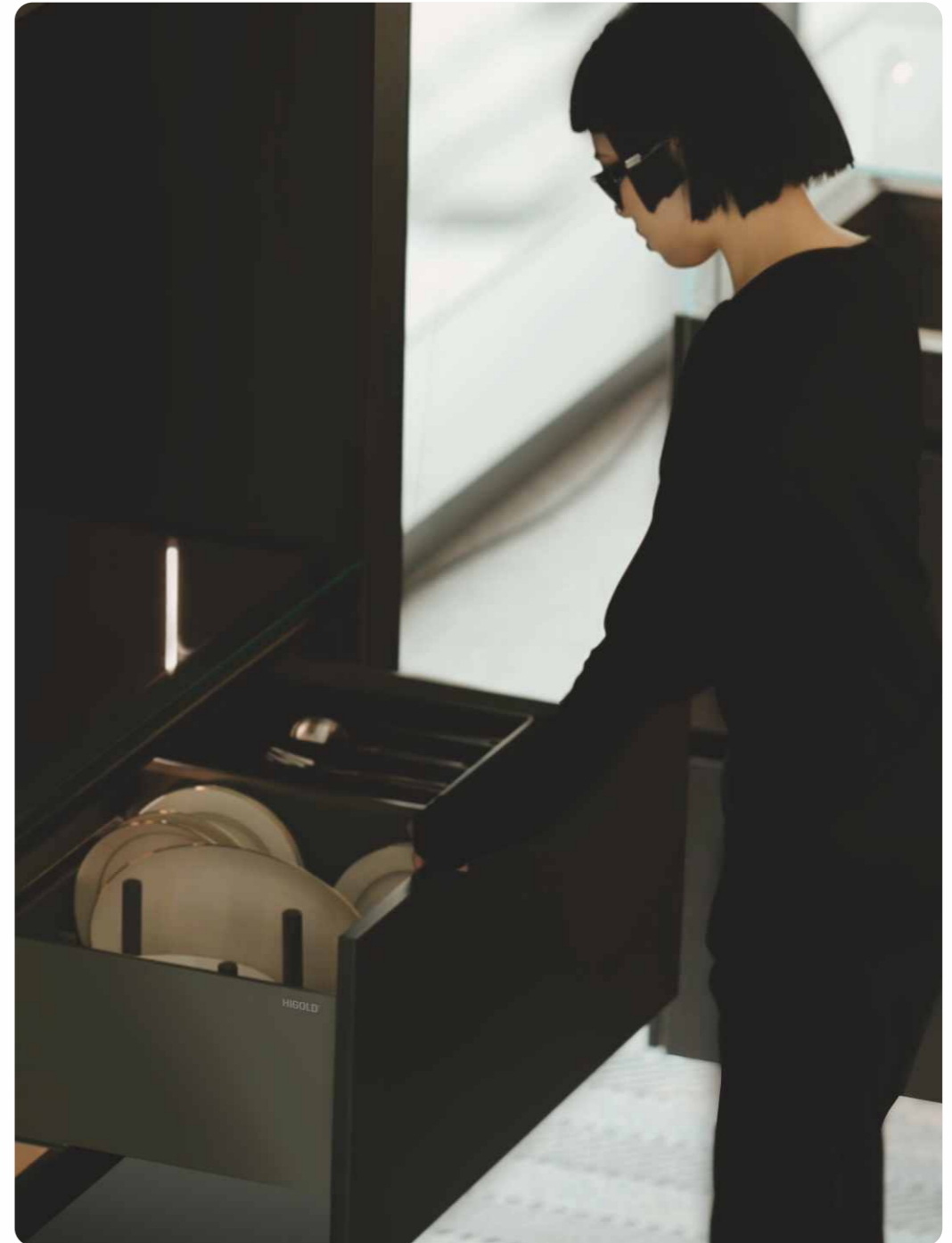

SHEARER SERIES

Artistic, Elegant, Exquisite.





TOURBILLON PANTRY

“360° Rotating” creating a comfort zone



Unique design, born extraordinary



TOURBILLON PANTRY

A Mechanical Piece Of Art
Mega Storage Space

HIGOLD

TOURBILLON PANTRY

Patent NO.: ZL202122510746.5
Patent NO.: ZL202230189307.6

Patented design on the serial movement with a dual structure and rotatable trays, smooth rotation and bold appearance, simple but remarkable. Quick access by swivelling the cabinet door, save time and effort. Tourbillon pantry represents a revolutionary way of experiencing the rotatable pantry, providing users with more convenient and comfortable cabinet storage solutions.



1. Open the cabinet door, bring the whole wall to your eyes.



2. If you want to get something inside the basket, turn the tray gently.



3. The tray can rotate 360°, and the way of fetching is easier.



4. After letting go, the basket body automatically returns to normal.

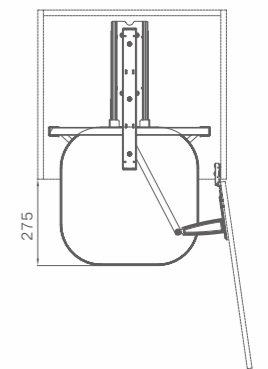
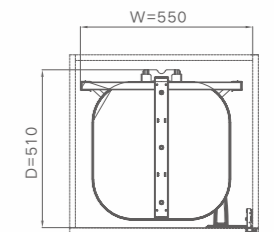

ART.NO	CABINET	W x D x H	MATERIAL	SURFACE	REMARK
202297	600mm	550x510x(1375-1675)mm	Steel+Aluminum	Nano-coating	4 layers
202298	600mm	550x510x(1675-1975)mm	Steel+Aluminum	Nano-coating	5 layers
202299	600mm	550x510x(1975-2275)mm	Steel+Aluminum	Nano-coating	6 layers

SHEARER STORAGE DRAWER

Independent storage
multi-layer pull-out

HIGOLD®





SHEARER / SERIES





TALL UNIT STORAGE DRAWER

Patent NO.: CN202430120402X

Patent NO.: CN2024301204015

Patent NO.: CN2024301204000

Using the principle of spatial structure, the multi-layer adjustable storage is constructed to give excellent storage performance.

	ART.NO	CABINET	W x D x H	MATERIAL	SURFACE	REMARK
	Storage Pull Out A	303801	600mm	564x480x90 mm	Aluminum	Soft close
	Storage & Wine Glass	303802	600mm	564x480x110 mm	Aluminum	Soft close
	Wine Storage Pull Out	303803	600mm	564x480x110 mm	Aluminum	Soft close
	Storage Pull Out C	303804	600mm	564x480x90 mm	Aluminum	Soft close
	Storage Pull Out B	303805	600mm	564x480x90 mm	Aluminum	Soft close



SHEARER SPACE PANTRY

Bring you the extraordinary elegant enjoyment
with the gesture of inspiring home appliance





SHEARER / SERIES

SPACE PANTRY

Patent NO.: ZL201420232580.2
 Patent NO.: ZL201511009012.1
 Patent NO.: ZL201430122180.1

Use the principle of space structure to build multi-layer adjustable storage, giving excellent storage performance. Not only is it equipped with door body linkage opening and closing to improve the convenience of storage, but also equipped with silent heavy-duty slide rails, the opening and closing are smooth and smooth, comfortable and quiet!

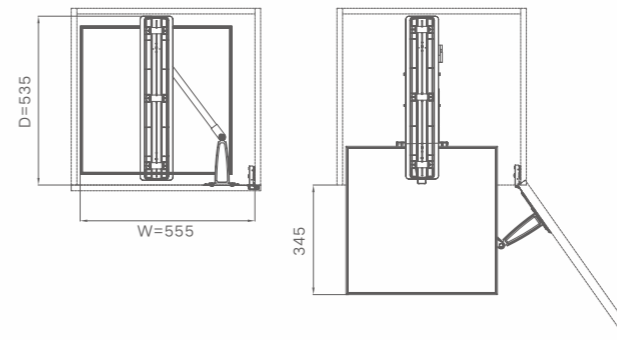

ART.NO	CABINET	W x D x H	MATERIAL	SURFACE	REMARK
205182	500mm	455x535x(1720-2020)mm	Steel+Aluminum	Nano-coating	5 layers
205183	500mm	455x535x(2020-2320)mm	Steel+Aluminum	Nano-coating	6 layers
205185	600mm	555x535x(1720-2020)mm	Steel+Aluminum	Nano-coating	5 layers
205186	600mm	555x535x(2020-2320)mm	Steel+Aluminum	Nano-coating	6 layers

SHEARER TALL LARDER UNITS

Storage aesthetics, fashionable style

+

HIGOLD®

The beauty
of industrial design!





SHEARER / SERIES

TALL LARDER UNITS

Patent NO. : ZL201830253630.9
 Patent NO. : Z7201922047348.7

The Shearer Tandem Pullout Pantry, utilizes the narrow kitchen storage space efficiently, makes it more convenient for storage. Stylish matt grey nano-coated surface, offering pleasing and comfortable kitchen experience.

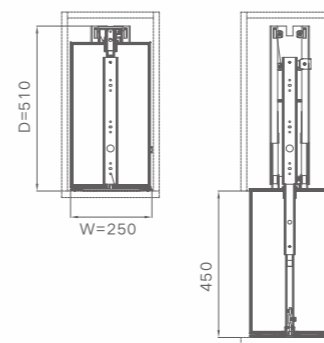

ART.NO	CABINET	W x D x H	MATERIAL	SURFACE	REMARK
201181	300mm	250x510x(1259-1659)mm	Steel+Aluminum	Nano-coating	4 layers
201182	300mm	250x510x(1659-2059)mm	Steel+Aluminum	Nano-coating	5 layers
201183	300mm	250x510x(1959-2359)mm	Steel+Aluminum	Nano-coating	6 layers
201184	400mm	350x510x(1259-1659)mm	Steel+Aluminum	Nano-coating	4 layers
201185	400mm	350x510x(1659-2059)mm	Steel+Aluminum	Nano-coating	5 layers
201186	400mm	350x510x(1959-2359)mm	Steel+Aluminum	Nano-coating	6 layers

SHEARER SWIVEL PULL OUT

Innate strong storage power

HIGOLD

The beauty
of industrial design!



HIGOLD
**SHEARER SWIVEL
PULL OUT**

Artistic, Elegant, Exquisite.
Leading Design, Perfect Experience.

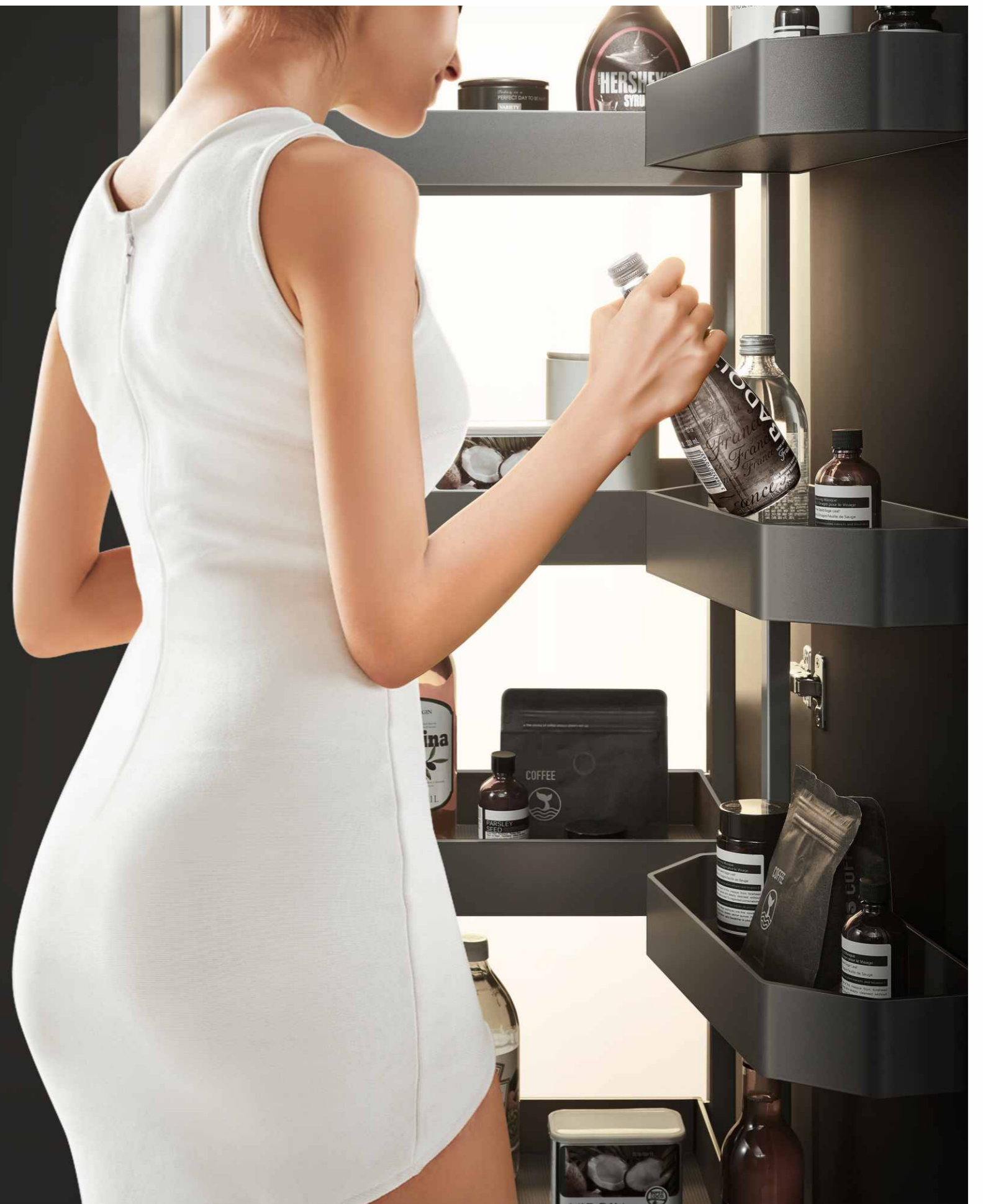



SHEARER / SERIES

SHEARER SWIVEL PULL OUT

Patent NO.: ZL201920460643.2
Patent NO.: ZL202220774037.X

With mega storage space, the Shearer Swivel Pullout Pantry offers flexible partitions for all kinds of stuffs, easily pull out the basket with swivelling door, easy and effortless access to every layer under the great performance of the heavy-duty slide. Smooth movement and strong bearing capacity.

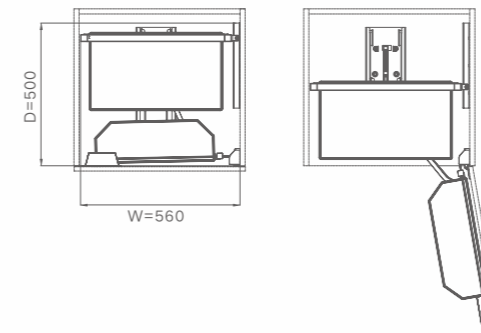

ART.NO	CABINET	W x D x H	MATERIAL	SURFACE	REMARK
202251	450-500mm	410x500x1325mm	Steel+Aluminum	Nano-coating	4 layers
202252	450-500mm	410x500x1625mm	Steel+Aluminum	Nano-coating	5 layers
202253	450-500mm	410x500x1825mm	Steel+Aluminum	Nano-coating	6 layers
202254	600mm	560x500x1325mm	Steel+Aluminum	Nano-coating	4 layers
202255	600mm	560x500x1625mm	Steel+Aluminum	Nano-coating	5 layers
202256	600mm	560x500x1825mm	Steel+Aluminum	Nano-coating	6 layers



SHEARER NARROW TALL LARDER UNITS

HIGOLD®

The beauty
of industrial design!



SHEARER / SERIES

NARROW TALL LARDER UNITS

Patent NO. : ZL201830253630.9
 Patent NO. : Z7201922047348.7

The Shearer Tandem Pullout Pantry, utilizes the narrow kitchen storage space efficiently, makes it more convenient for storage. Stylish matt grey nano-coated surface, offering pleasing and comfortable kitchen experience.

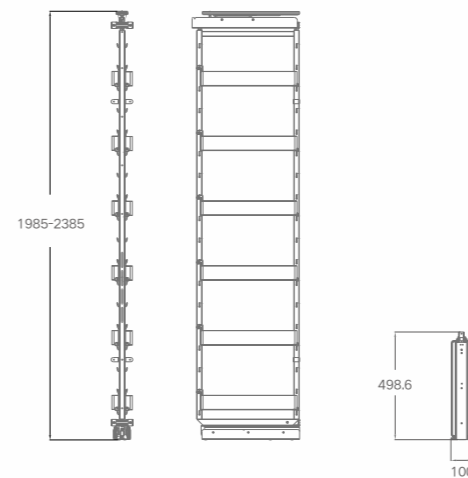

ART.NO	CABINET	W x D x H	MATERIAL	SURFACE	REMARK
201191	150mm	100x510x(1285-1685)mm	Steel+Aluminum	Nano-coating	4 layers
201192	150mm	100x510x(1685-2085)mm	Steel+Aluminum	Nano-coating	5 layers
201193	150mm	100x510x(1985-2385)mm	Steel+Aluminum	Nano-coating	6 layers
201194	200mm	145x510x(1285-1685)mm	Steel+Aluminum	Nano-coating	4 layers
201195	200mm	145x510x(1685-2085)mm	Steel+Aluminum	Nano-coating	5 layers
201196	200mm	145x510x(1985-2385)mm	Steel+Aluminum	Nano-coating	6 layers

NEBULA LIFT BASKET

Innate strong storage power

HIGOLD®





A Mechanical Piece Of Art
Mega Storage Space

HIGOLD
NEBULA LIFT BASKET



NEBULA / SERIES

NEBULA 2.0 LIFT BASKET

Patent NO. : ZL202230189304.2

The Higold Nebula Lift has comprehensively innovated the Galaxy Mechanical Lifting System, two-way lifting buffer damping design, combined with personalized 3-gear adjustment buttons, to provide consumers with a more comfortable solution for storage and retrieval of wall cabinets, bringing consumers more joy of kitchen lift, giving consumers a higher quality of kitchen life experience. Nebula Lift integrates with 3-gear speed boost adjuster, allowing consumers to adjust rebound strength and balance according to the weight of the item placed, giving a cloud-like push and pull experience.

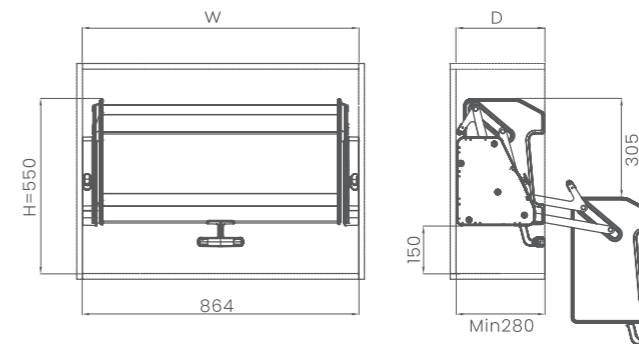

ART.NO	CABINET	W x D x H	MATERIAL	SURFACE
401291	600mm	564x280x465mm	Steel+Aluminum	Nano-coating
401292	700mm	664x280x465mm	Steel+Aluminum	Nano-coating
401293	800mm	764x280x465mm	Steel+Aluminum	Nano-coating
401294	900mm	864x280x465mm	Steel+Aluminum	Nano-coating

requirem: bottom panel have to open 256mm

SHEARER LIFT BASKET

Lift and lower freely, Within reach

HIGOLD®





SHEARER / SERIES

SHEARER LIFT BASKET

Patent NO. : ZL201830253637.0

It can be lifted up and down freely and within reach. With the mechanical load-bearing system, it is flexible and convenient to fetch objects from a height. The buffer damping function enables stable push and pull. Adjustable gravity gears shape a more user-friendly detail. Push and pull take less effort when adjusting the strength according to the weight of item.

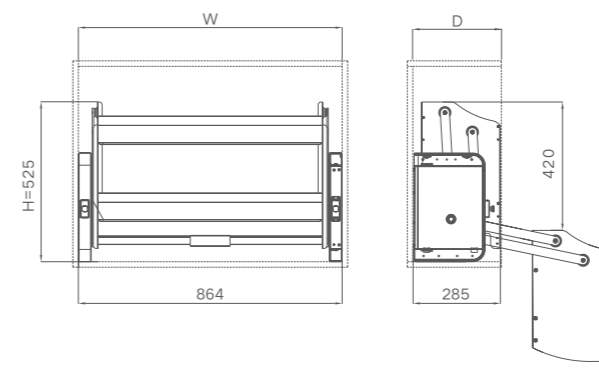

ART.NO	CABINET	W x D x H	MATERIAL	SURFACE
401221	600mm	564x285x525mm	Steel+Aluminum	Nano-coating
401222	700mm	664x285x525mm	Steel+Aluminum	Nano-coating
401223	800mm	764x285x525mm	Steel+Aluminum	Nano-coating
401224	900mm	864x285x525mm	Steel+Aluminum	Nano-coating

requirem: bottom panel have to open 256mm

HIGOLD®

STAR MOVE 2.0 LIFT-UP DISH RACK

Dedicated Tableware Storage,
Gesture Control

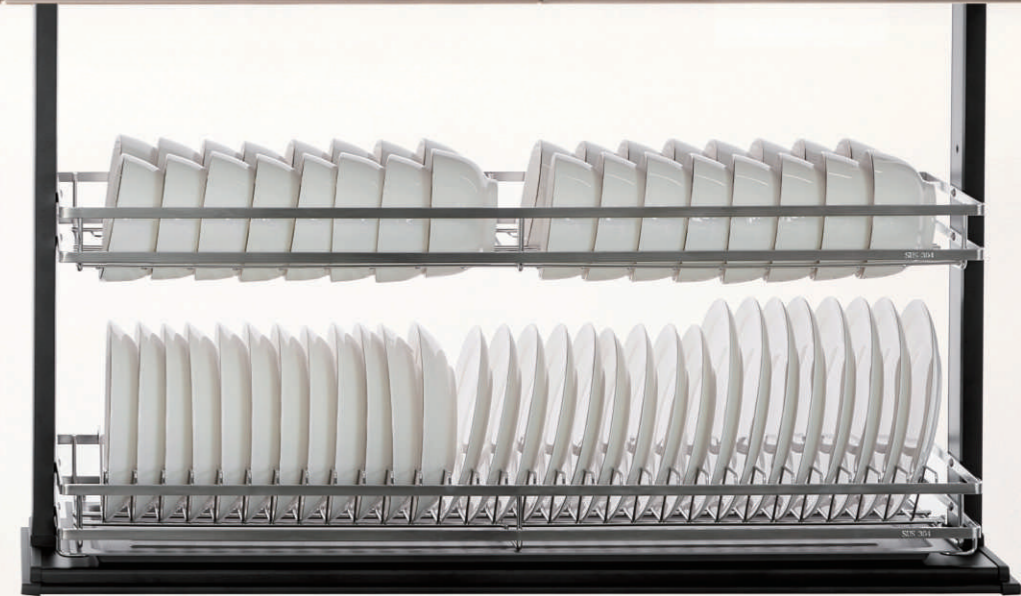



STAR MOVE 2.0 / SERIES

STAR MOVE 2.0 LIFT-UP DISH RACK (256)

Imagine a dish rack that understands your needs. The Star Move 2.0 Lift-up Dish Rack offers specialized storage for your bowls, plates, and cutlery, with an integrated drying tray to maintain perfect dryness and cleanliness. Its sturdy stainless-steel construction promises long-term, rust-free use. A wave of your hand or a simple touch is all it takes to interact with its intuitive gesture or touch controls, blending smart innovation seamlessly into your daily routine.

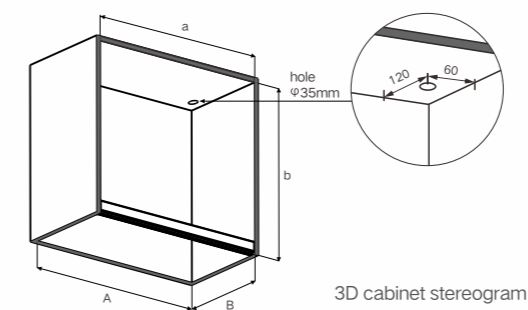

ART.NO	CABINET	SIZE a x b	BOTTOM PANEL AT LEAST OPEN SIZE A x B	MATERIAL	SURFACE	COLOR
401476	600mm	564x664mm	564x256mm	Steel+SUS 304	Nano-coating+Electrolysis	Gray+Silver
401475	700mm	664x664mm	664x256mm	Steel+SUS 304	Nano-coating+Electrolysis	Gray+Silver
401474	800mm	764x664mm	764x256mm	Steel+SUS 304	Nano-coating+Electrolysis	Gray+Silver
401473	900mm	864x664mm	864x256mm	Steel+SUS 304	Nano-coating+Electrolysis	Gray+Silver

requirem: bottom panel have to open 256mm | Notes: Cabinet rear panel minimum size:16mm



STAR MOVE 2.0 ELECTRICAL BOWL AND DISH LIFT BASKET

(Full-size 294mm basket)

Offer easy and versatile storage for even large items

HIGOLD®



STAR MOVE 2.0 / SERIES

STAR MOVE 2.0 ELECTRICAL BOWL AND DISH LIFT BASKET (294)

Elevate your kitchen experience with the Star Move 2.0 Electrical Bowl and Dish Lift Basket. Imagine a storage solution so spacious it effortlessly accommodates your largest dishes, yet so thoughtfully organized with exclusive compartments for bowls, dishes, and cutlery. The integrated drying tray ensures everything stays spotless and dry. A simple wave of your hand or a gentle touch is all it takes to activate its smooth, quiet operation, redefining elegance in your kitchen.

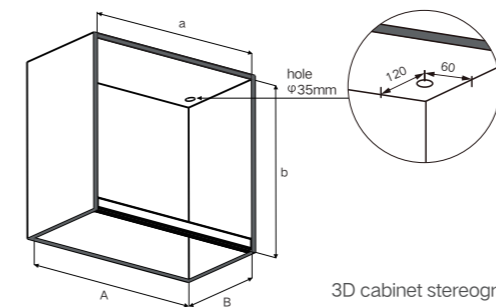

ART.NO	CABINET	SIZE a x b	BOTTOM PANEL AT LEAST OPEN SIZE A x B	MATERIAL	SURFACE	COLOR
401472	600mm	564x664mm	564x294mm	Steel+Aluminum	Nano-coating	Premium Gray
401471	700mm	664x664mm	664x294mm	Steel+Aluminum	Nano-coating	Premium Gray
401470	800mm	764x664mm	764x294mm	Steel+Aluminum	Nano-coating	Premium Gray
401469	900mm	864x664mm	864x294mm	Steel+Aluminum	Nano-coating	Premium Gray

requirem: bottom panel have to open 294mm | Notes: Cabinet rear panel minimum size:16mm



STAR MOVE 2.0 ELECTRICAL LIFT BASKET

(182)

Gesture Control, Seamless Operation

HIGOLD®



STAR MOVE 2.0 ELECTRICAL LIFT BASKET (182)

Star Move 2.0 Electric Lift System, innovative sensing technology enables intelligent control with a wave of your hand opening and closing freely and hovering at will, and equipped with a breakthrough silent system, you can enjoy 38db quiet lifting; installation efficiency is increased by 50%, and you can easily enjoy extraordinary texture and fill the room with elegance.

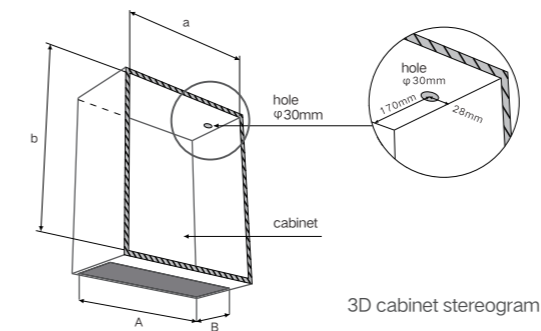

ART.NO	CABINET	SIZE a x b	BOTTOM PANEL AT LEAST OPEN SIZE A x B	MATERIAL	SURFACE	COLOR
401401	600mm	564x664mm	564x182mm	Steel+Aluminum	Nano-coating	Premium Gray
401402	700mm	664x664mm	664x182mm	Steel+Aluminum	Nano-coating	Premium Gray
401403	800mm	764x664mm	764x182mm	Steel+Aluminum	Nano-coating	Premium Gray
401404	900mm	864x664mm	864x182mm	Steel+Aluminum	Nano-coating	Premium Gray

requirement: bottom panel have to open 256mm | Notes: Cabinet rear panel minimum size:16mm



**STAR MOVE 2.0
ELECTRICAL LIFT
BASKET**

(256)

Bring you the extraordinary elegant enjoyment
with the gesture of inspiring home appliance

STAR MOVE 2.0 ELECTRICAL LIFT BASKET (256)

Star Move 2.0 Electric Lift System, innovative sensing technology enables intelligent control with a wave of your hand opening and closing freely and hovering at will, and equipped with a breakthrough silent system, you can enjoy 38db quiet lifting; installation efficiency is increased by 50%, and you can easily enjoy extraordinary texture and fill the room with elegance.

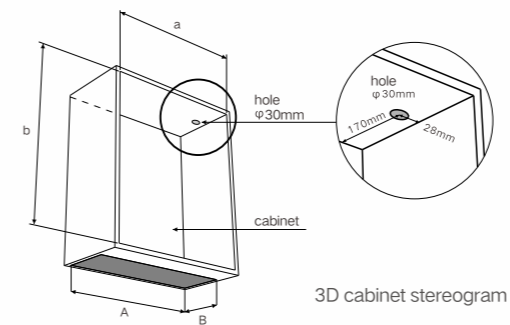

ART.NO	CABINET	SIZE a x b	BOTTOM PANEL AT LEAST OPEN SIZE A x B	MATERIAL	SURFACE	COLOR
401451	600mm	564x664mm	564x256mm	Steel+Aluminum	Nano-coating	Premium Gray
401452	700mm	664x664mm	664x256mm	Steel+Aluminum	Nano-coating	Premium Gray
401453	800mm	764x664mm	764x256mm	Steel+Aluminum	Nano-coating	Premium Gray
401454	900mm	864x664mm	864x256mm	Steel+Aluminum	Nano-coating	Premium Gray

requirem: bottom panel have to open 256mm | Notes: Cabinet rear panel minimum size:16mm



STAR MOVE Pro ELECTRICAL LIFT BASKET

Spatial Ingenuity
Advanced Smart Cabinet Storage Solutions

HIGOLD®



Every inch of space has been carefully considered to create a variety of storage spaces in the kitchen

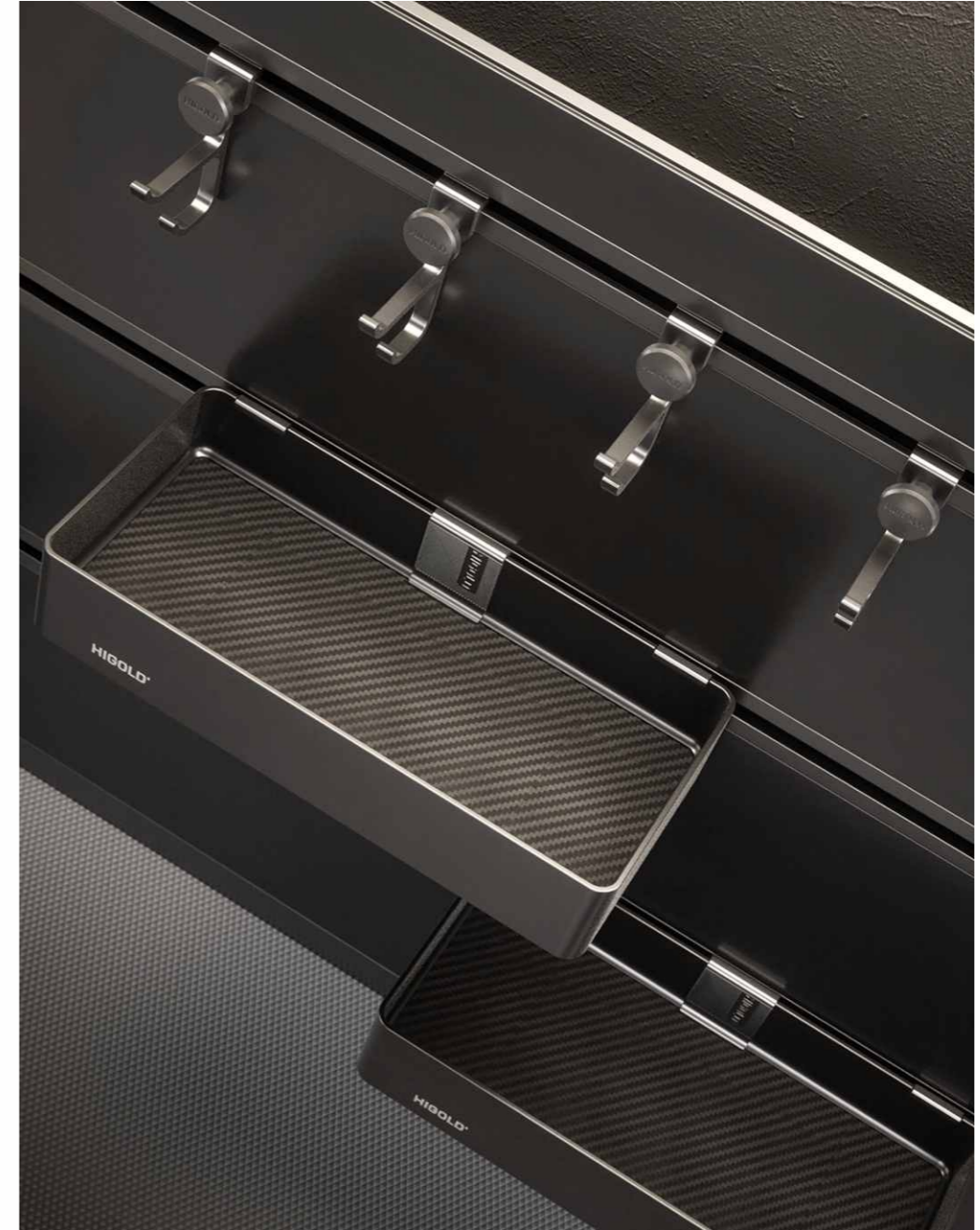

Detachable design, adjustable layout, easy disassembly, convenient maintenance, versatile applications

STAR MOVE Pro ELECTRICAL LIFT BASKET

Star Move Pro electric lift has a sophisticated space layout.

Every space and design has been carefully considered to create diverse storage in the kitchen.

Intelligent touch sensor enables lifting and lowering with just one touch.

Multifunctional layout design, smart use of every inch of space, detachable design, flexible layout, easy to clean.

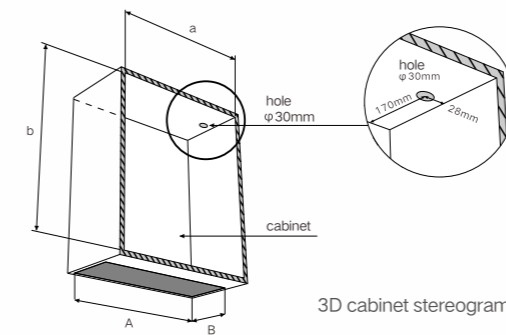

ART.NO	CABINET	SIZE a x b	BOTTOM PANEL AT LEAST OPEN SIZE A x B	MATERIAL	SURFACE	COLOR
401381	600mm	564x664mm	564x256mm	Steel+Aluminum	Nano-coating	Premium Gray
401382	700mm	664x664mm	664x256mm	Steel+Aluminum	Nano-coating	Premium Gray
401383	800mm	764x664mm	764x256mm	Steel+Aluminum	Nano-coating	Premium Gray
401384	900mm	864x664mm	864x256mm	Steel+Aluminum	Nano-coating	Premium Gray

requirem: bottom panel have to open 256mm | Notes: Cabinet rear panel minimum size:16mm

SHEARER SWING TRAY 3.0

Streamlined & light

HIGOLD®

Improve life with design inspiration





SHEARER / SERIES

SWING TRAYS 3.0

Patent NO.: ZL202010424189.2
 Patent NO.: ZL202130385109.2

Higold Swing Tray 3.0 – Shearer Style realizes a new pull-out motion trajectory of rotary cut-in through precise mechanical design of two axes and points. In the exquisite motion trajectory, it realizes the balanced fusion of aesthetics, function and interaction, greatly improving corner storage experience and satisfying the diverse needs for personalized storage of consumers.

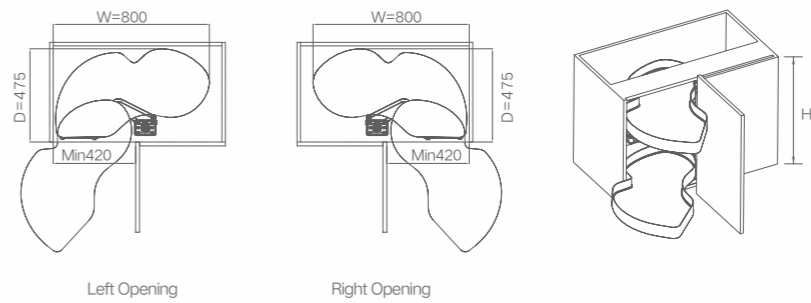

ART.NO	CABINET	W x D x H	MATERIAL	SURFACE	REMARK
101081	≥900mm	800x475x(600-750)mm	Steel+Aluminum	Nano-coating	2 layers/ left opening
101082	≥900mm	800x475x(600-750)mm	Steel+Aluminum	Nano-coating	2 layers/ right opening



SHEARER MAGICCORNER

Extraordinary corner
storage experience

HIGOLD®





SHEARER / SERIES

SHEARER MAGIC CORNER

Patent NO.: ZL202122637437.4
Patent NO.: ZL202122637501.9

It utilizes the corner space of kitchen to realize "no dead corner storage", reducing squatting and facilitating use.
High-performance damping slides, trouble-free open and close, quiet and smooth.
Stable product structure with steady push and pull, durable service life and worry-free quality.

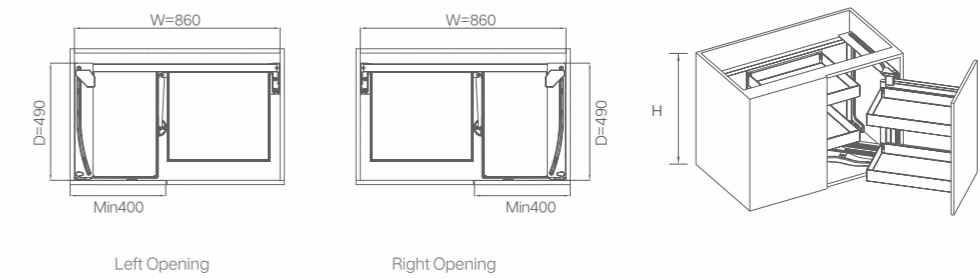

ART.NO	CABINET	W x D x H	MATERIAL	SURFACE	REMARK
101055	≥900mm	860x490x535mm	Steel+Aluminum	Nano-coating	left opening
101056	≥900mm	860x490x535mm	Steel+Aluminum	Nano-coating	right opening



SHOW HAND MAGIC CORNER

Light and flexible
diverse kitchen storage

HIGOLD®



SHEARER / SERIES

SHOW HAND MAGIC CORNER

Shearer show hand corner use the split design so that all the baskets can be pulled quietly. Re-enter the deep cabinet hardware is also instantly visible, palpable, to create elegant, easy and convenient kitchen life experience.

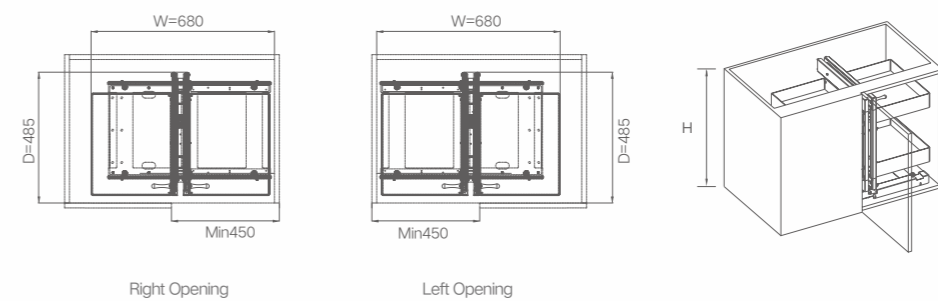

ART.NO	CABINET	W x D x H	MATERIAL	SURFACE	REMARK
101148	≥800mm	680x485x590mm	Steel+Aluminum	Nano-coating	left/right opening

SHEARER 4.0MAX BASE UNITS

HIGOLD®
Original Design & Quality



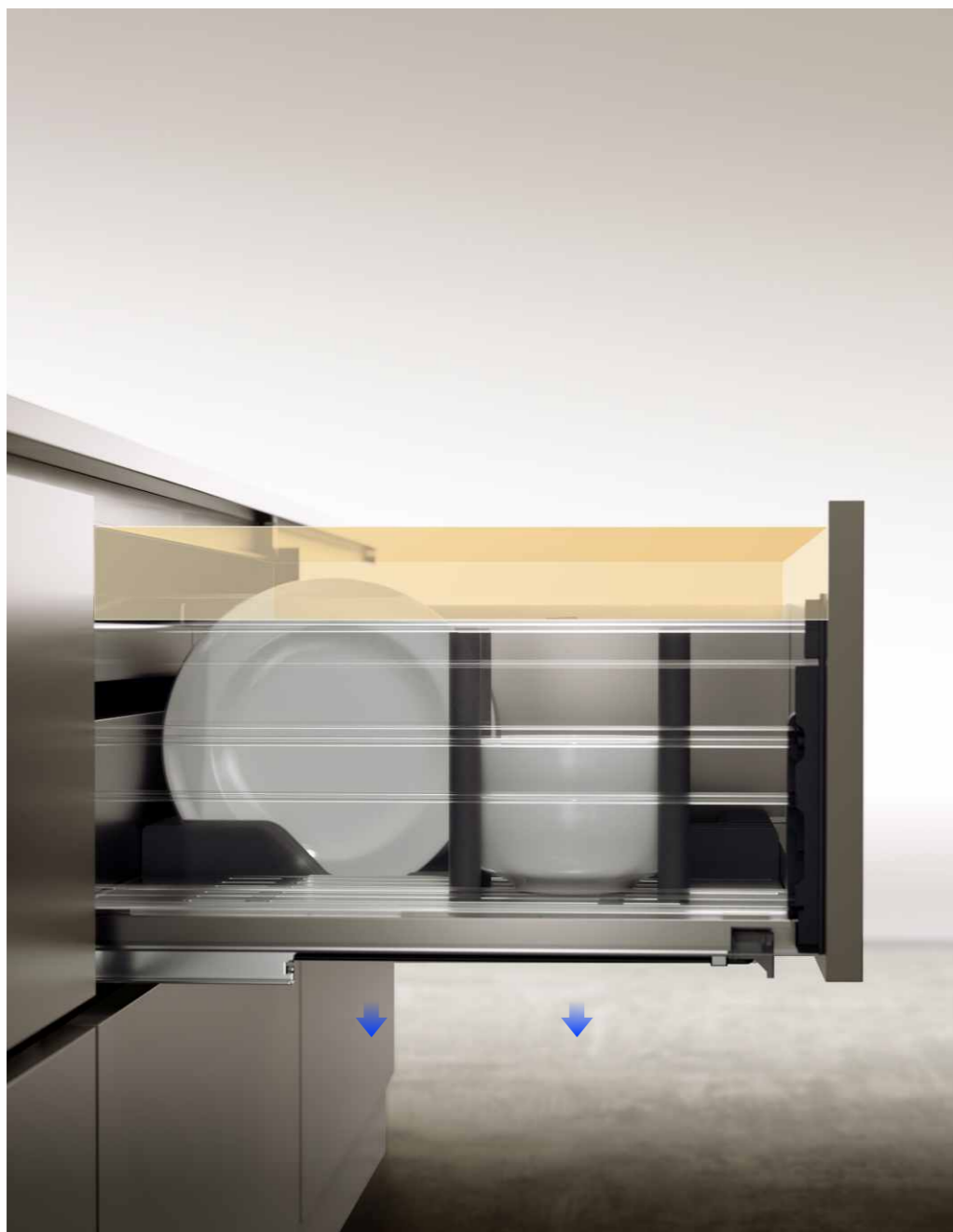

It sinks 20mm to solve the problem of collision between the invisible handle and the disc.







Modular functional components can be disassembled, making usage and cleaning more convenient.

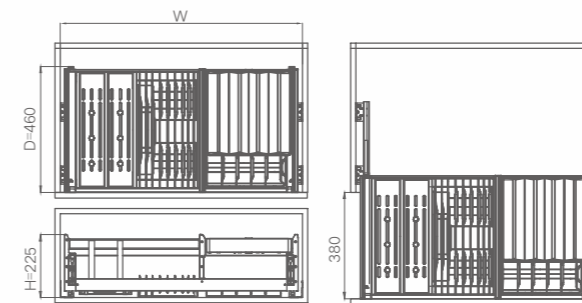

SHEARER 4.0 MAX THREE SIDES PULL OUT BASKET

Two layers total five area for larger storage space. While left side for the bigger item, right side enable with a two layers design. Consider for the low space, this basket sinks 20mm to avoid the interference for the dishes and cabinet. Fully using the height for the racks to make the larger space for the basket.



	ART.NO	CABINET	W x D x H	MATERIAL	SURFACE	COLOR
	303951	600mm	564x450x225mm	Aluminum	Nano-coating	Gray
	303952	700mm	664x450x225mm	Aluminum	Nano-coating	Gray
	303954	800mm	764x450x225mm	Aluminum	Nano-coating	Gray
	303955	900mm	864x450x225mm	Aluminum	Nano-coating	Gray

Remarks: The pull-out basket is equipped with channels, screws and other mounting accessories.

SHEARER 4.0 PRO BASE UNITS

PULL OUT MULTI PURPOSE BASKET

+

HIGOLD®

Original Design & Quality

HIGOLD®





It sinks 20mm,
solving the problem of collision between the hidden handle and dishes.

Modular functional components can be disassembled,
making usage and cleaning more convenient.







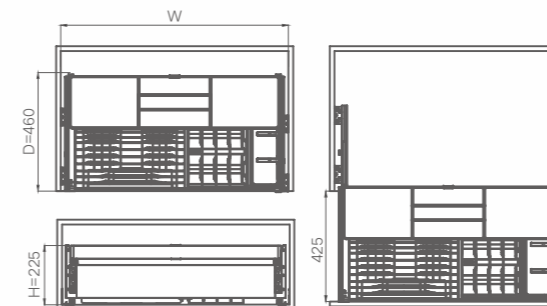

SHEARER 4.0 PRO PULL OUT MULTI PURPOSE BASKET

Sinking 20mm to solve the problem of collision between the invisible handle and the dishes. Drawer in drawer, fine classification; Fully hidden slide, silk-sliding push and pull; Fish plate design, more inclusive storage. Modular design, detachable functions, cleaning more convenient.



	ART.NO	CABINET	W x D x H	MATERIAL	SURFACE	COLOR
	303885	600mm	564x460x235mm	Aluminum	Nano-coating	Gray
	303884	700mm	664x460x235mm	Aluminum	Nano-coating	Gray
	303882	800mm	764x460x235mm	Aluminum	Nano-coating	Gray
	303881	900mm	864x460x235mm	Aluminum	Nano-coating	Gray

Remarks: The pull-out basket is equipped with channels, screws and other mounting accessories.

SHEARER 4.0 BASE UNITS

Drawer in Drawer





Modular functional components can be disassembled,
making usage and cleaning more convenient.

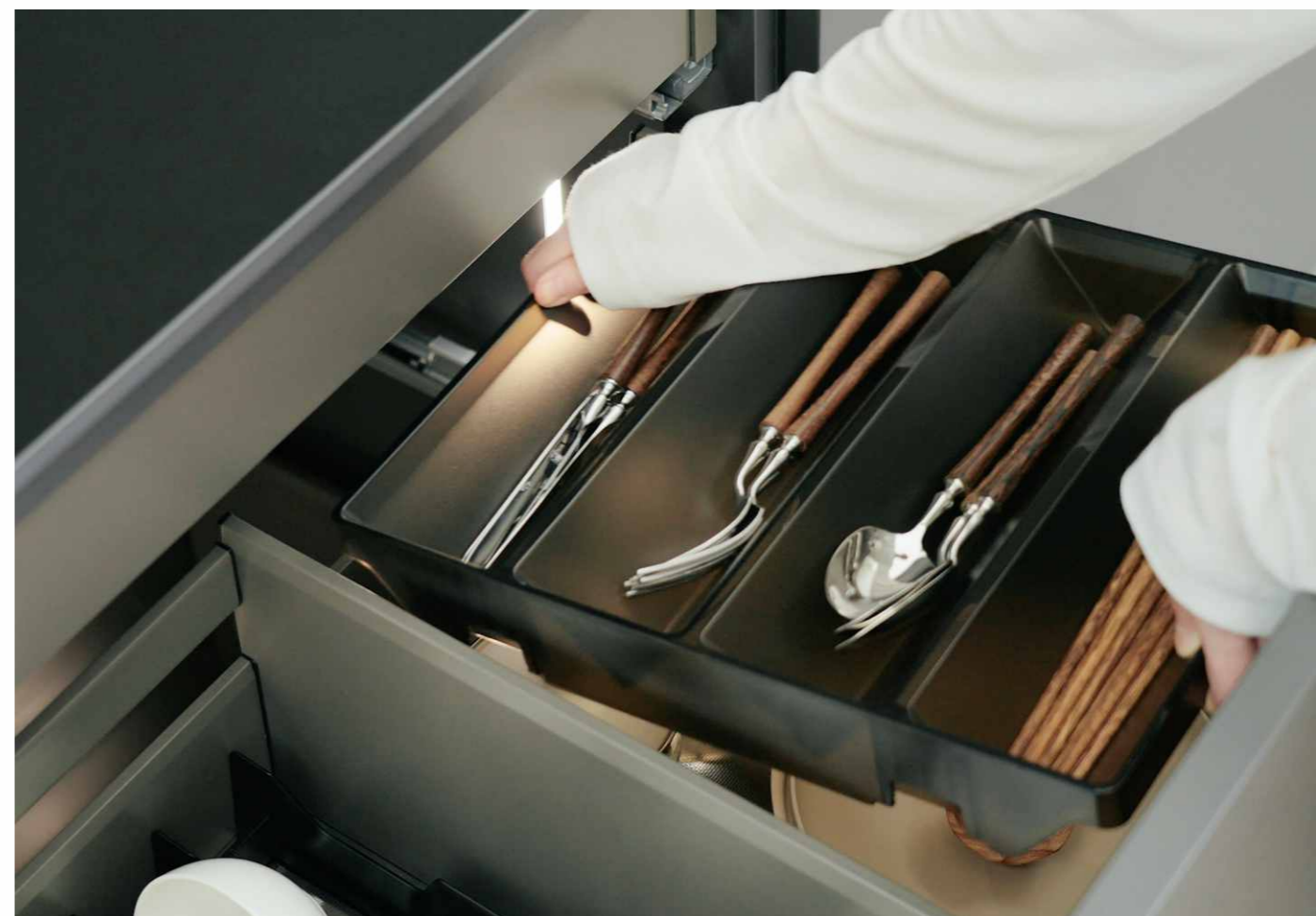





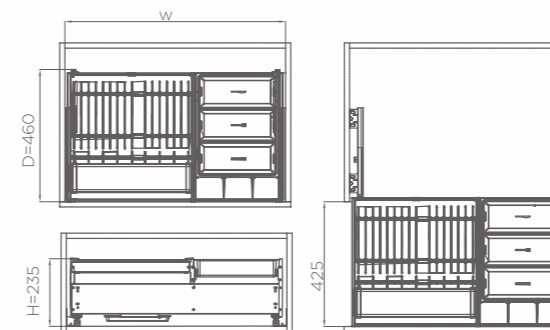

SHEARER 4.0 PULL OUT MULTI PURPOSE BASKET

Through upgrading and optimizing product material, product structure, aesthetic design and so on,reshaping space and upgrading storage. Space aluminum alloy basket body, make the product more light, strong, scratch resistant and easy to clean, ensure durable.



Patent NO. : ZL202130850255.8
 Patent NO. : ZL202030057021.3
 Patent NO. : ZL202020963650.7
 Patent NO. : ZL202122547978.8
 Patent NO. : ZL202130857647.7
 Patent NO. : ZL202130163682.9
 Patent NO. : ZL202130850264.7
 Patent NO. : ZL202030057005.4
 Patent NO. : ZL202020957731.6
 Patent NO. : ZL202122547978.8

	ART.NO	CABINET	W x D x H	MATERIAL	SURFACE	COLOR
	303585	600mm	564x460x235mm	Aluminum	Nano-coating	Gray
	303584	700mm	664x460x235mm	Aluminum	Nano-coating	Gray
	303582	800mm	764x460x235mm	Aluminum	Nano-coating	Gray
	303581	900mm	864x460x235mm	Aluminum	Nano-coating	Gray

Remarks: The pull-out basket is equipped with channels, screws and other mounting accessories.



SHEARER4.0 / SERIES

SHEARER 4.0 PULL OUT BASKET

Patent NO.: ZL202130850255.8
 Patent NO.: ZL202030057021.3
 Patent NO.: ZL202020963650.7
 Patent NO.: ZL202122547978.8
 Patent NO.: ZL202130857647.7
 Patent NO.: ZL202130163682.9
 Patent NO.: ZL202130850264.7
 Patent NO.: ZL202030057005.4
 Patent NO.: ZL202020957731.6
 Patent NO.: ZL202122547978.8

Upgrades design and materials comprehensively. Optimizes material, structure, and aesthetic to customize storage space and layout for more capacity, Large - sized visible flat basket holds big pots and basins. The spacious platform stores large cookware like pot sets and small kitchen appliances.

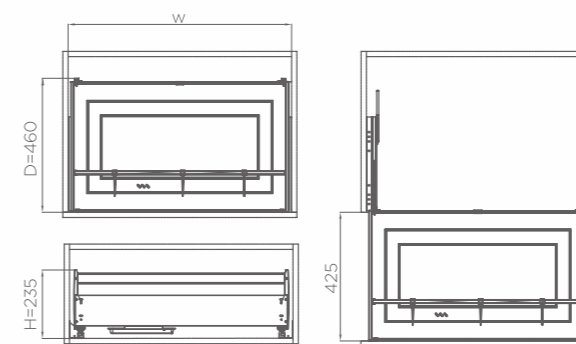

ART.NO	CABINET	W x D x H	MATERIAL	SURFACE	COLOR
303595	600mm	564x460x235mm	Aluminum	Nano-coating	Gray
303594	700mm	664x460x235mm	Aluminum	Nano-coating	Gray
303592	800mm	764x460x235mm	Aluminum	Nano-coating	Gray
303591	900mm	864x460x235mm	Aluminum	Nano-coating	Gray



Drawer in Drawer-Push

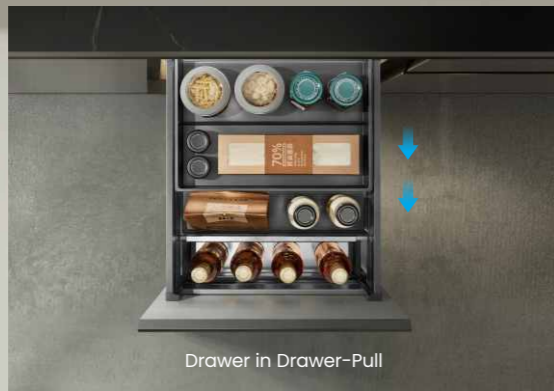

Drawer in Drawer-Pull



SHEARER 4.0

SEASONING PULL OUT BASKET

Drawer in Drawer





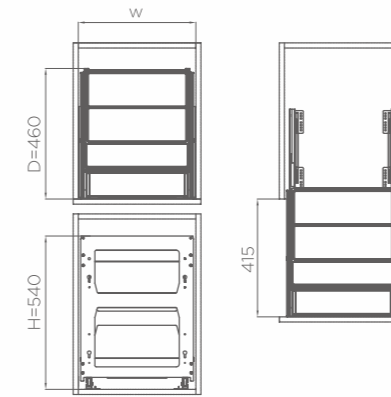

SHEARER 4.0 SEASONING PULL OUT BASKET

innovative structure for endless use. Four - layer, five - zone layout for smart organization, speeding up kitchen tasks, inner - drawer - within-drawer design breaks boundaries, unlocking storage potential. The "mini - drawer" feature allows easy access to lower -layer items by pushing in the upper layer, maximizing drawer space utilization.



Patent NO.: ZL202130850255.8
 Patent NO.: ZL202030057021.3
 Patent NO.: ZL202020963650.7
 Patent NO.: ZL202122547978.8
 Patent NO.: ZL202130857647.7
 Patent NO.: ZL202130163682.9
 Patent NO.: ZL202130850264.7
 Patent NO.: ZL202030057005.4
 Patent NO.: ZL202020957731.6
 Patent NO.: ZL202122547978.8

	ART.NO	CABINET	W x D x H	MATERIAL	SURFACE	COLOR
	306271	300mm	264x460x540mm	Aluminum	Nano-coating	Gray
	306272	350mm	314x460x540mm	Aluminum	Nano-coating	Gray
	306273	400mm	364x460x540mm	Aluminum	Nano-coating	Gray
	306274	450mm	414x460x540mm	Aluminum	Nano-coating	Gray

Remarks: The pull-out basket is equipped with channels, screws and other mounting accessories.



SHEARER 4.0 MAGIC DRAWER

Receive with inherent strong force, to create more likely to receive





SHEARER 4.0 / SERIES

SHEARER 4.0 MAGIC DRAWER

Patent NO. : ZL202130163270.5

Patent NO. : ZI202122547978.8

Shearer 4.0 magic drawer , by optimizing the product material, structure, aesthetic design, etc., Will receive a space subdivision, adjustable, meet the demand of users receive a variety of kitchen utensils, clean the kitchen bring comfortable and relaxed.

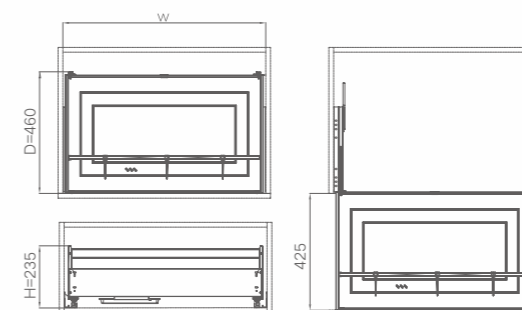

ART.NO	CABINET	W x D x H	MATERIAL	SURFACE
303575	600mm	550x460x235mm	Aluminum	Nano-coating
303574	700mm	650x460x235mm	Aluminum	Nano-coating
303572	800mm	750x460x235mm	Aluminum	Nano-coating
303571	900mm	850x460x235mm	Aluminum	Nano-coating



HIGOLD®
Original Design & Quality

+

SHEAREA 3.0 MAX BASE UNITS



Sinks 20mm, increasing storage height by 20%

☑ Cruise-ship-style dinnerware tray. Utilizes double-layer space.







☑ Modular functional components can be removed, making use and cleaning easier.

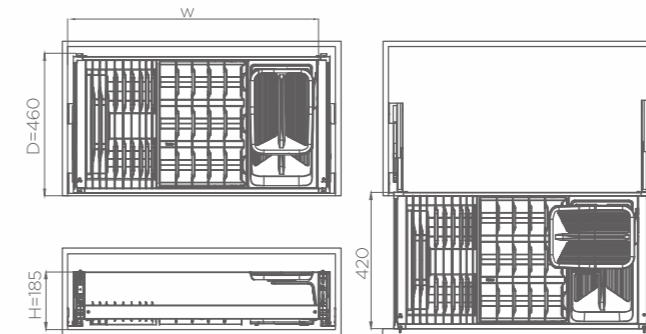

SHEARER 3.0 MAX THREE SIDES PULL OUT BASKET

Sinks 20mm to solve the collision problem between the invisible handle and dishes, Inner- drawer - within- drawer design for reined classification. Fully- concealed guide rails ensure smooth siding. Zones are well- organized. The basket holds all- sized tableware needed for cooking. With a see -through aesthetic, it hides the charm of life.



	ART.NO	CABINET	W x D x H	MATERIAL	SURFACE	COLOR
	303875	600mm	564x460x185mm	Aluminum+Glass	Nano-coating	Gray
	303874	700mm	664x460x185mm	Aluminum+Glass	Nano-coating	Gray
	303872	800mm	764x460x185mm	Aluminum+Glass	Nano-coating	Gray
	303871	900mm	864x460x185mm	Aluminum+Glass	Nano-coating	Gray

Remarks: The pull-out basket is equipped with channels, screws and other mounting accessories.



SHEARER 3.0 BASE UNITS

Limpid and bright,
a universe of expectation



ORIGINAL DESIGN & QUALITY



SHEARER 3.0 PULL OUT MULTI PURPOSE BASKET

With black crystal - tempered finish, it shines with brilliance, ingeniously designed to enhance creative storage, it maximizes the space utilization within the pull - out basket. The overall design is ultra - minimalist, stylish and generous, elevating both the aesthetic and storage experience in the kitchen.

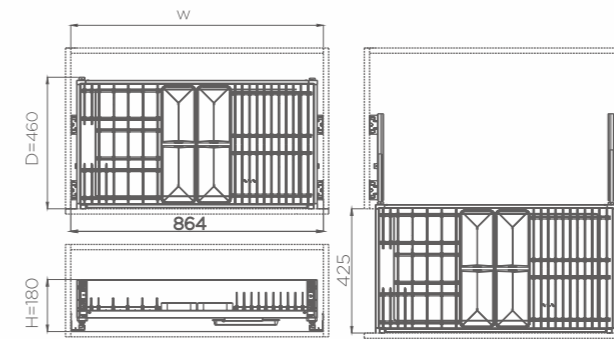

Patent NO.: ZL202020957904.4
 Patent NO.: ZL202020958081.7
 Patent NO.: ZL202130163354.9
 Patent NO.: ZL202030056722.5
 Patent NO.: ZL202030057132.4
 Patent NO.: ZL202020963648.X

	ART.NO	CABINET	W x D x H	MATERIAL	SURFACE	COLOR
	303555	600mm	564x450x180mm	Aluminum+Glass	Nano-coating	Gray
	303554	700mm	664x450x180mm	Aluminum+Glass	Nano-coating	Gray
	303552	800mm	764x450x180mm	Aluminum+Glass	Nano-coating	Gray
	303551	900mm	864x450x180mm	Aluminum+Glass	Nano-coating	Gray

Remarks: The pull-out basket is equipped with channels, screws and other mounting accessories.



SHEARER3.0 / SERIES

SHEARER 3.0 PULL OUT BASKET

Patent NO.: ZL202020957904.4
 Patent NO.: ZL202020958081.7
 Patent NO.: ZL202130163354.9
 Patent NO.: ZL202030056722.5
 Patent NO.: ZL202030057132.4
 Patent NO.: ZL202020963648.X

The large - sized visible flat basket can hold big pots and basins. The detachable ABS water-collecting tray prevents water from pooling. With creative storage design, it maximizes the space utilization within the pul - out basket. Stylish and generous, it enhances the aesthetic and storage experience in the kitchen.

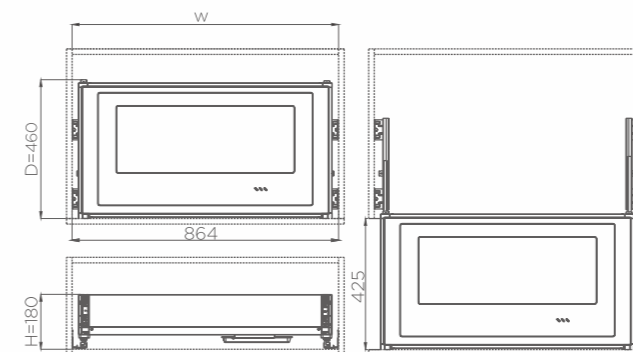

ART.NO	CABINET	W x D x H	MATERIAL	SURFACE	COLOR
303565	600mm	564x450x180mm	Aluminum+Glass	Nano-coating	Gray
303564	700mm	664x450x180mm	Aluminum+Glass	Nano-coating	Gray
303562	800mm	764x450x180mm	Aluminum+Glass	Nano-coating	Gray
303561	900mm	864x450x180mm	Aluminum+Glass	Nano-coating	Gray





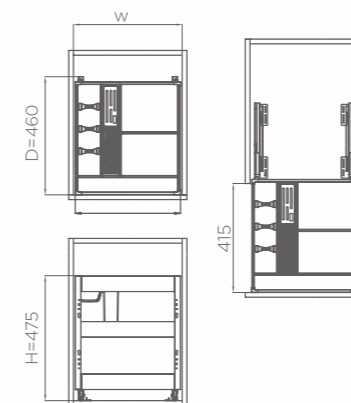

SHEARER 3.0 SEASONING PULL OUT BASKET

Three - layer, six - zone layout for rational classification speeds up kitchen tasks. The three - tier design, with varying heights, easily accommodates items of different heights without interference, optimizing space utilization. Movable dividers keep boles stable; they can be adjusted freely according to bottle sizes, ensuring smooth sliding without wobbling.



Patent NO.: ZL202020957904.4
 Patent NO.: ZL202020958081.7
 Patent NO.: ZL202130163354.9
 Patent NO.: ZL202030056722.5
 Patent NO.: ZL202030057132.4
 Patent NO.: ZL202020963648.X

	ART.NO	CABINET	W x D x H	MATERIAL	SURFACE	COLOR
	306291	300mm	264x450x475mm	Aluminum+Glass	Nano-coating	Gray
	306292	350mm	314x450x475mm	Aluminum+Glass	Nano-coating	Gray
	306293	400mm	364x450x475mm	Aluminum+Glass	Nano-coating	Gray
	306294	450mm	414x450x475mm	Aluminum+Glass	Nano-coating	Gray

Remarks: The pull-out basket is equipped with channels, screws and other mounting accessories.

SHEARER 3.0 Mini BASE UNITS

Limpid and bright,
a universe of expectation

The beauty
of industrial design!



Kitchen Functional Hardware

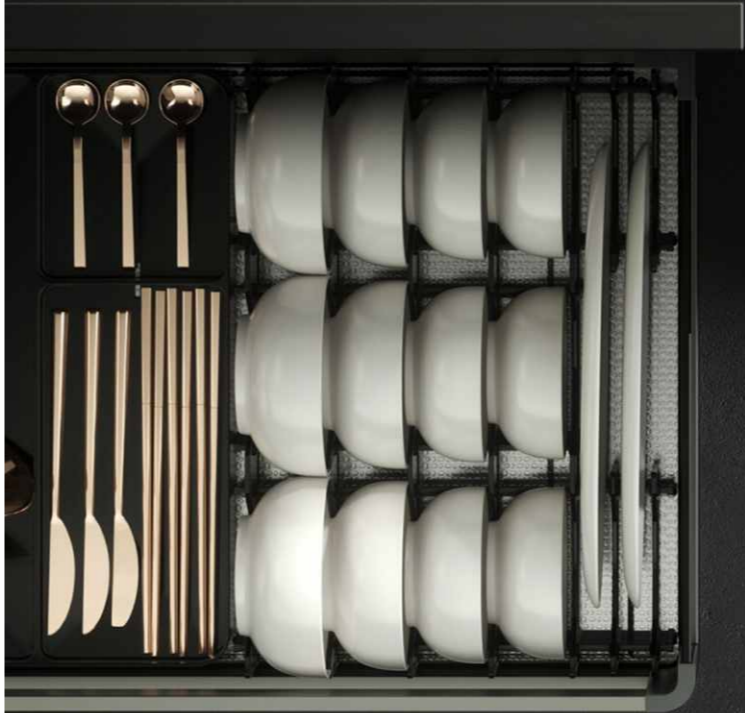
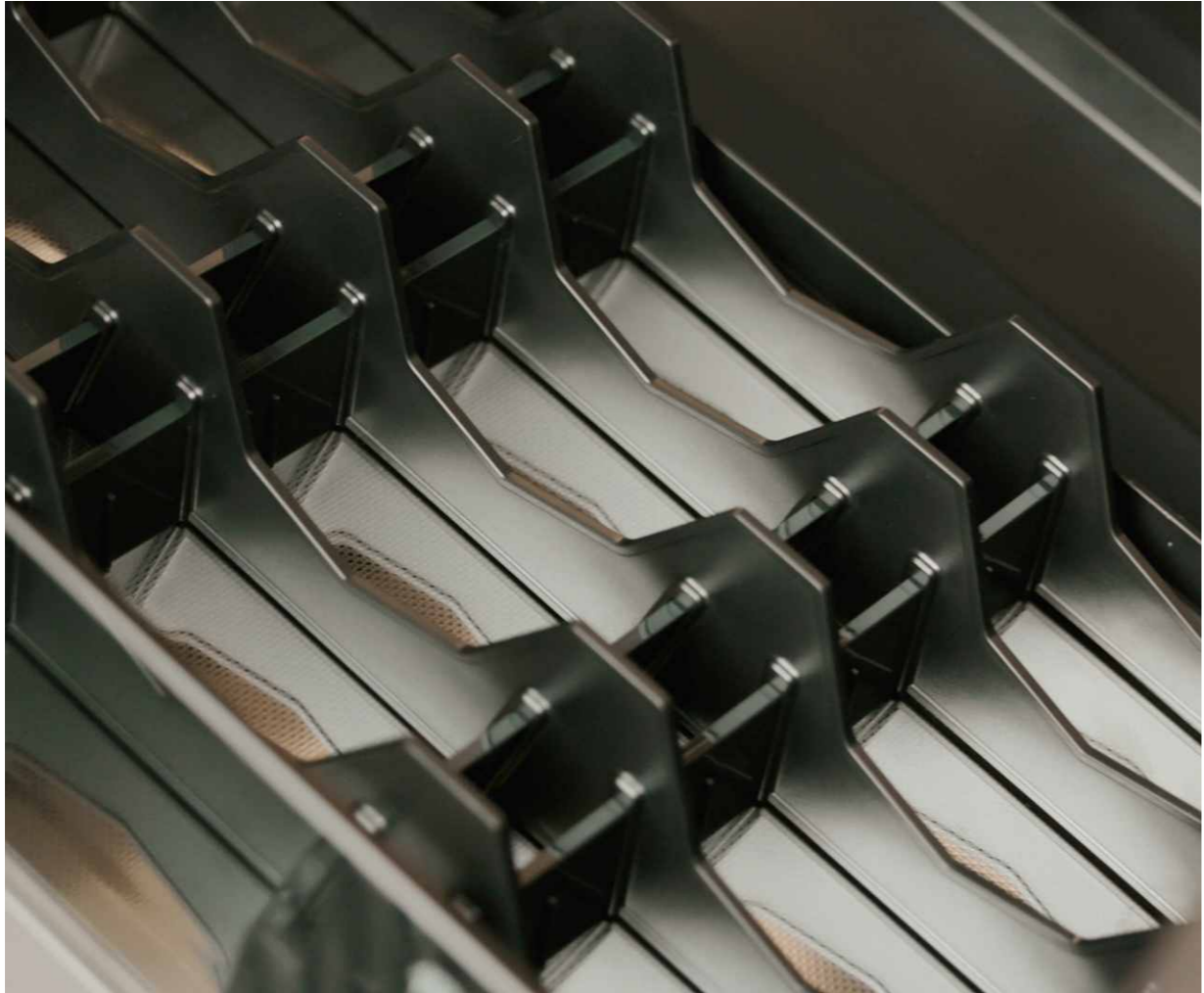





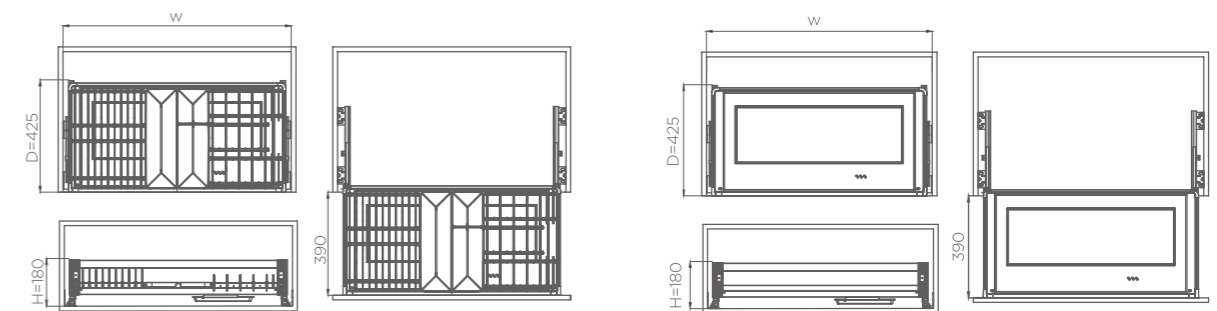

SHEARER 3.0 Mini PULL OUT BASKET (TWO BASKET)

Larger glass panels eliminate boundaries. Increasing the glass proportion enhances lighting for a more transparent look. Compact in size yet with greater capacity. The entire basket's compartments are re-designed to maximize every inch of space, increasing dish storage by 5%. With modular combinations, customization reaches new heights.



	ART.NO	CABINET	W x D x H	MATERIAL	SURFACE	COLOR
	303625	600mm	564x425x180mm	Aluminum+Glass	Nano-coating	Gray
	303624	700mm	664x425x180mm	Aluminum+Glass	Nano-coating	Gray
	303622	800mm	764x425x180mm	Aluminum+Glass	Nano-coating	Gray
	303621	900mm	864x425x180mm	Aluminum+Glass	Nano-coating	Gray

Remarks: The pull-out basket is equipped with channels, screws and other mounting accessories.



SHEARER 3.0 mini SEASONING BASKET

Exquisitely carved and finely
seasoned for storage

HIGOLD®



SHEARER3.0 mini / SERIES

SHEARER 3.0 mini SEASONING BASKET

Exquisite and translucent, for storing various flavors. The flat, unobstructed layer allows for more casual storage. The duplex - flat structure offers greater freedom in organizing. With a single partition for fine - grained zoning. Silicone seals at both ends ensure precise locking without displacement, The offset space allocates areas rationally for bottles of different heights, even accommodating large oil drums.

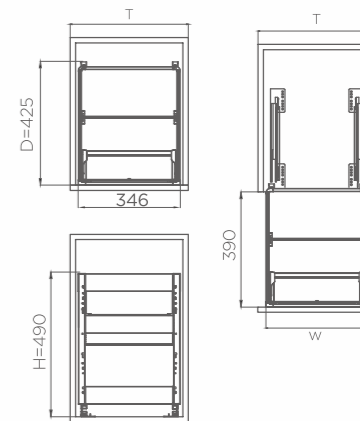

	ART.NO	CABINET	W x D x H	MATERIAL	SURFACE	COLOR
	306411	300mm	264x425x490mm	Aluminum+Glass	Nano-coating	Gray
	306412	350mm	314x425x490mm	Aluminum+Glass	Nano-coating	Gray
	306413	400mm	364x425x490mm	Aluminum+Glass	Nano-coating	Gray
	306414	450mm	414x425x490mm	Aluminum+Glass	Nano-coating	Gray

Remarks: The pull-out basket is equipped with channels, screws and other mounting accessories.

SHEARER 6.0 Mini BASE UNITS

Fashionable style
reconstruct imagination

The beauty
of industrial design!





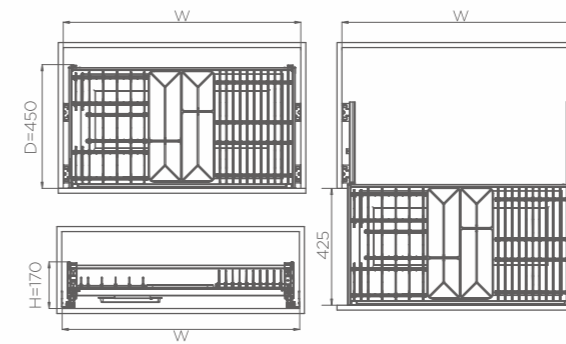

SHEARER 6.0 Mini PULL OUT MULTI PURPOSE BASKET

Stainless - steel original color, trendy and outstanding, Embracing minimalism, it features a stylish panel design in metallic silver, blending smart storage with industrial aesthetics that exceed imagination. With a newly - upgraded layout, the overall storage capacity increases by 38%, The detachable structure allows free switching between dish basket and flat basket.

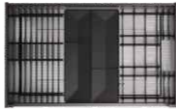
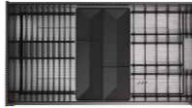

	ART.NO	CABINET	W x D x H	MATERIAL	SURFACE	COLOR
	303755	600mm	564x450x170mm	SS	Brushed	matte
	303754	700mm	664x450x170mm	SS	Brushed	matte
	303752	800mm	764x450x170mm	SS	Brushed	matte
	303751	900mm	864x450x170mm	SS	Brushed	matte

Remarks: The pull-out basket is equipped with channels, screws and other mounting accessories.



SHEARER 6.0 Mini PULL OUT BASKET

Detachable structure enables free switching between dish basket and flat basket, making it multi-functional. It can store dishes and cutlery; remove the rack to store large cookware. With a minimalist and stylish panel design in metallic silver, it combines smart storage with industrial aesthetics beyond imagination.

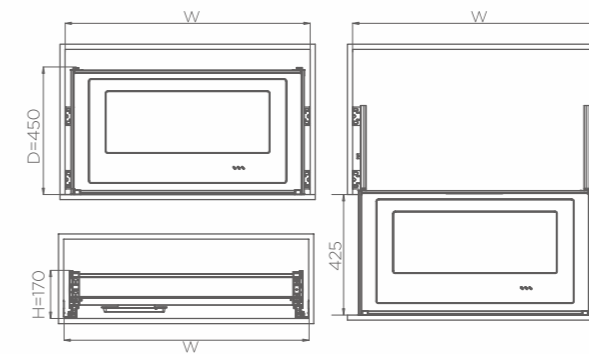

ART.NO	CABINET	W x D x H	MATERIAL	SURFACE	COLOR
303765	600mm	564x450x170mm	SS	Brushed	Matte
303764	700mm	664x450x170mm	SS	Brushed	Matte
303762	800mm	764x450x170mm	SS	Brushed	Matte
303761	900mm	864x450x170mm	SS	Brushed	Matte



SHEARER6.0 Mini / SERIES

SHEARER 6.0 mini SEASONING PULL OUT BASKET

With Multiple storage place on top layer and increasing height design for the bottom layer, which make it easier to storage for the 5L oil tank, it is dedicating for seasoning storage and keep the cupboard clean and clear.

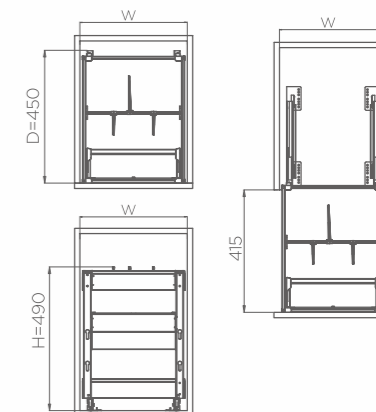

	ART.NO	CABINET	W x D x H	MATERIAL	SURFACE	COLOR
	306381	300mm	264x450x487mm	Aluminum+Glass	Nano-coating	Gray
	306382	350mm	314x450x487mm	Aluminum+Glass	Nano-coating	Gray
	306383	400mm	364x450x487mm	Aluminum+Glass	Nano-coating	Gray
	306384	450mm	414x450x487mm	Aluminum+Glass	Nano-coating	Gray

Remarks: The pull-out basket is equipped with channels, screws and other mounting accessories.

PDL 2.0 BASE UNITS

Redefine Layout. Master Space.

HIGOLD®







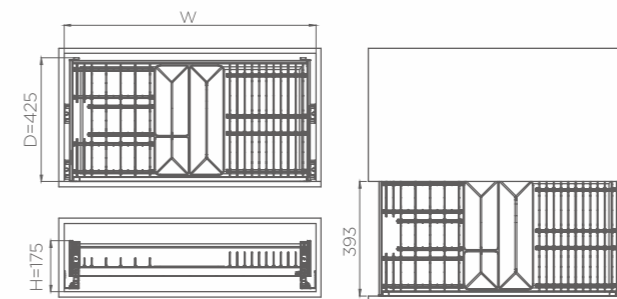

PDL 2.0 SERIES PULL OUT MULTI PURPOSE BASKET

The new upgraded PDL 2.0 series simply design maximize the storage space, make the end user feel more tidy and Convenient . The drawer do not need to fully open and it can be taken out all the bowls, dishes, chopsticks and spoons



Patent NO.: ZL202230562498.6
Patent NO.: ZL202230562901.5
Patent NO.: ZL201521116688.6

	ART.NO	CABINET	W x D x H	MATERIAL	SURFACE	COLOR
	303381	600mm	564x425x175mm	SS	Brushed	Matte
	303382	700mm	664x425x175mm	SS	Brushed	Matte
	303384	800mm	764x425x175mm	SS	Brushed	Matte
	303385	900mm	864x425x175mm	SS	Brushed	Matte

Remarks: The pull-out basket is equipped with channels, screws and other mounting accessories.



PDL 2.0 / SERIES

PDL 2.0 SERIES PULL OUT BASKET

Patent NO.: ZL202230562498.6
 Patent NO.: ZL202230562901.5
 Patent NO.: ZL201521116688.6

Large flat layer design with the side design upgrade maximize the storage space and make it easy for cleaning, improving the convenient for the end user and tidy for the kitchen.

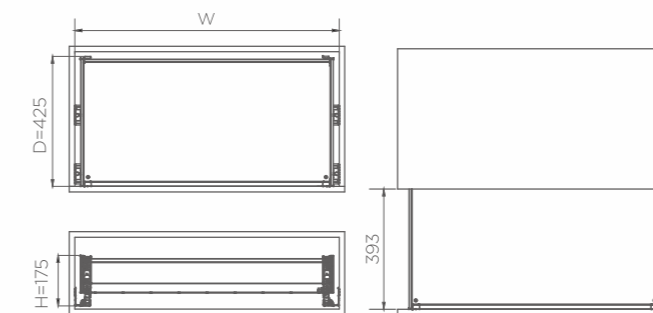

ART.NO	CABINET	W x D x H	MATERIAL	SURFACE	COLOR
303281	600mm	564x425x175mm	SS	Brushed	Matte
303282	700mm	664x425x175mm	SS	Brushed	Matte
303284	800mm	764x425x175mm	SS	Brushed	Matte
303285	900mm	864x425x175mm	SS	Brushed	Matte



PDL 2.0 SEASONAL POT BASKET

Kitchen Functional Hardware, Creative Living, Soul.



PDL 2.0 SEASONAL POT BASKET

Patent NO.: ZL202230562498.6
 Patent NO.: ZL202230562901.5
 Patent NO.: ZL201521116688.6

Seasoning storage is more simplified. Optimize the intermediate storage layer and have greater space, Reform the large flat-layer seasoning area, which is fully visible and clean and convenient.

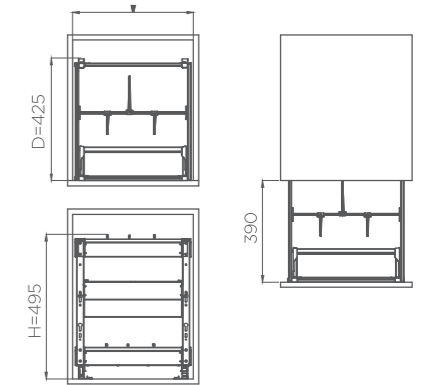

	ART.NO	CABINET	W x D x H	MATERIAL	SURFACE	COLOR
	306280	200mm	164x425x495mm	SS	Brushed	Matte
	306281	300mm	264x425x495mm	SS	Brushed	Matte
	306282	350mm	314x425x495mm	SS	Brushed	Matte
	306283	400mm	364x425x495mm	SS	Brushed	Matte
	306284	450mm	414x425x495mm	SS	Brushed	Matte

Remarks: The pull-out basket is equipped with channels, screws and other mounting accessories.



JING RAN

Couture selection, well organized

Jingran Sereis Drawer divider system

Patent NO. : CN2024205141382
Patent NO. : CN2024301204176
Patent NO. : CN2024301204161
Patent NO. : CN2024301204142
Patent NO. : CN2024301204138
Patent NO. : CN2024301204123
Patent NO. : CN2024301204231
Patent NO. : CN2024301204053
Patent NO. : CN2024301203987
Patent NO. : CN2024301203972
Patent NO. : CN2024301203953

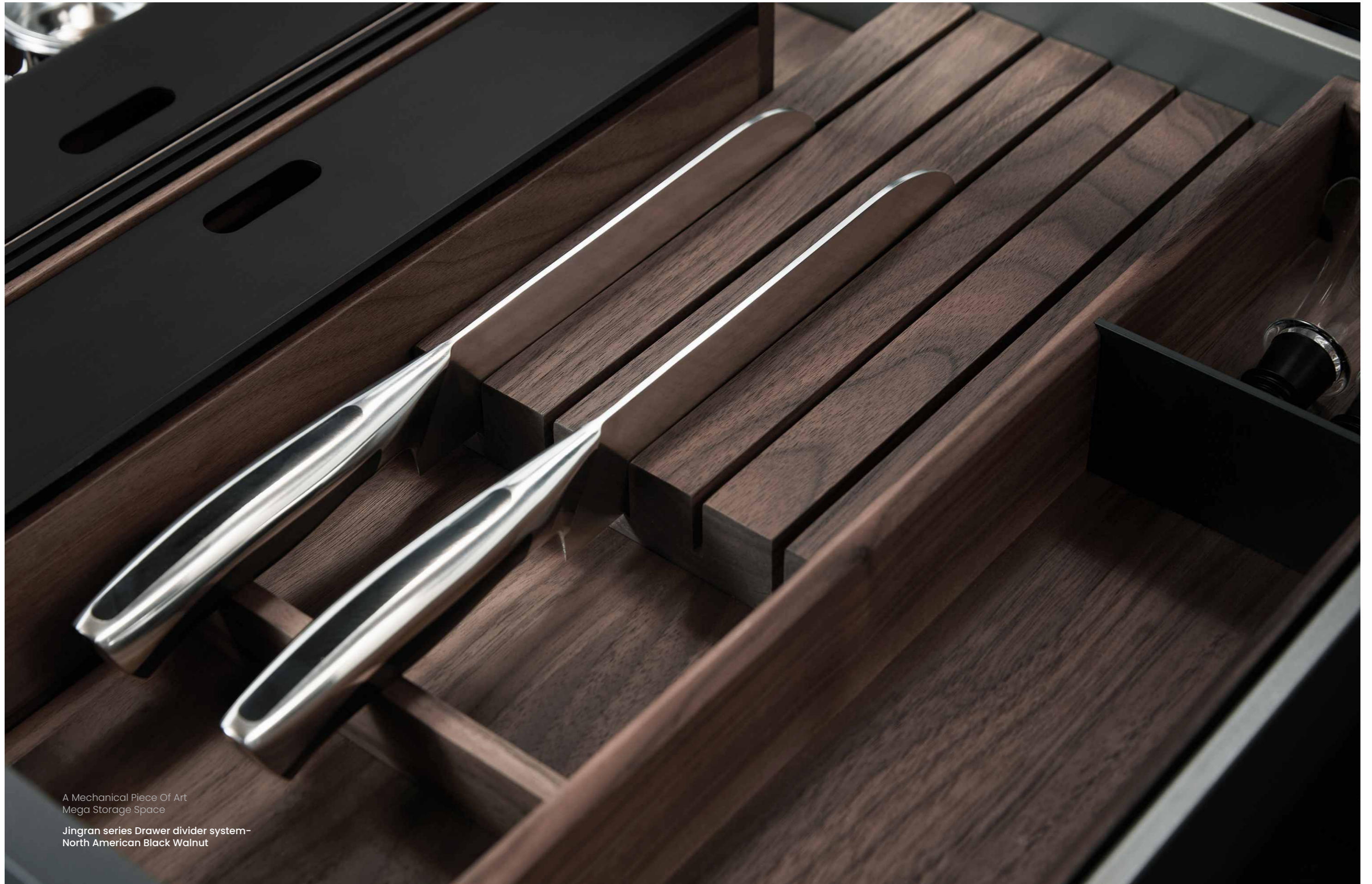

A Mechanical Piece Of Art
Mega Storage Space

Jingran series Drawer divider system-
North American Black Walnut

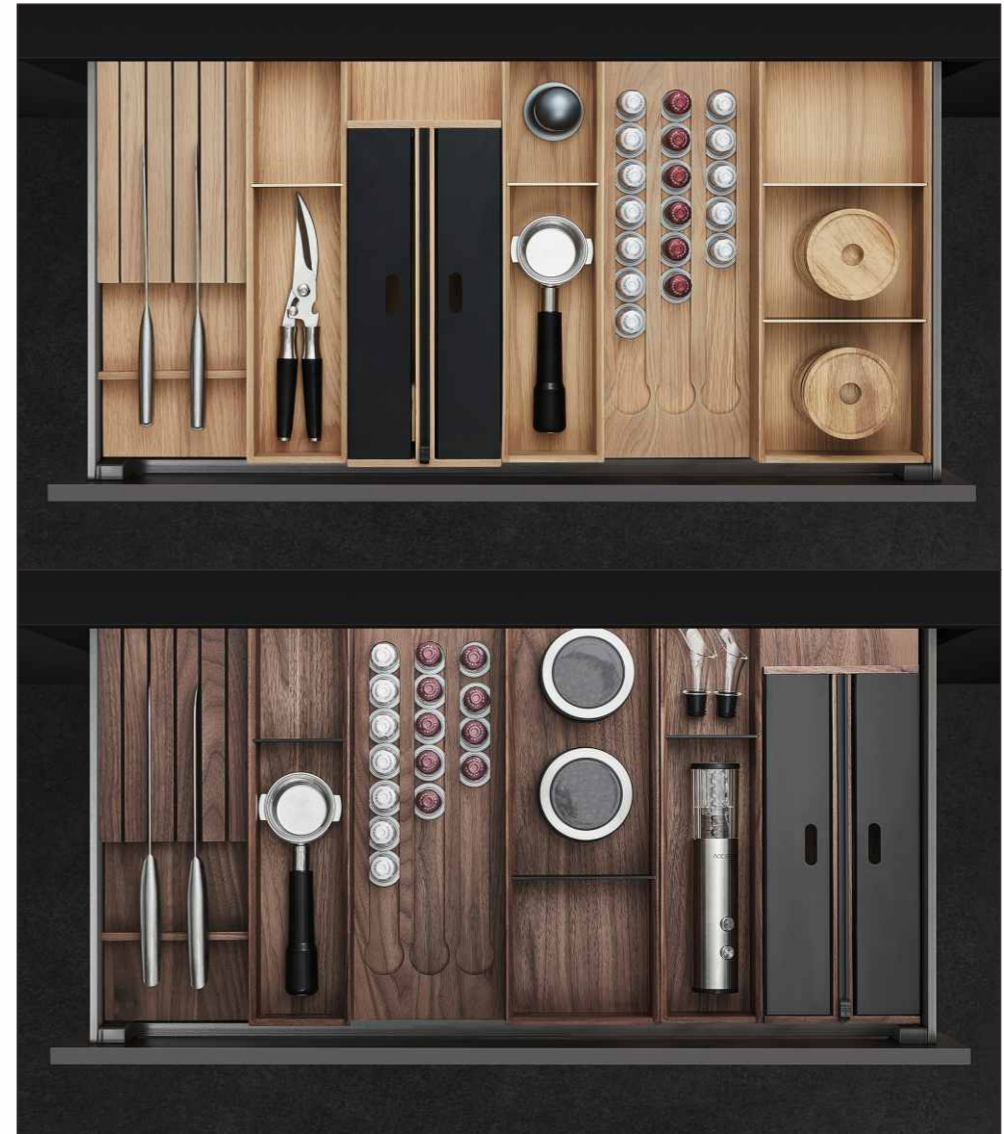

In Order, High-end Customization Well Organized,
Variety of combinations

Orderly layout,
simple and luxurious life aesthetics.

Scientific storage, multiple stacking.



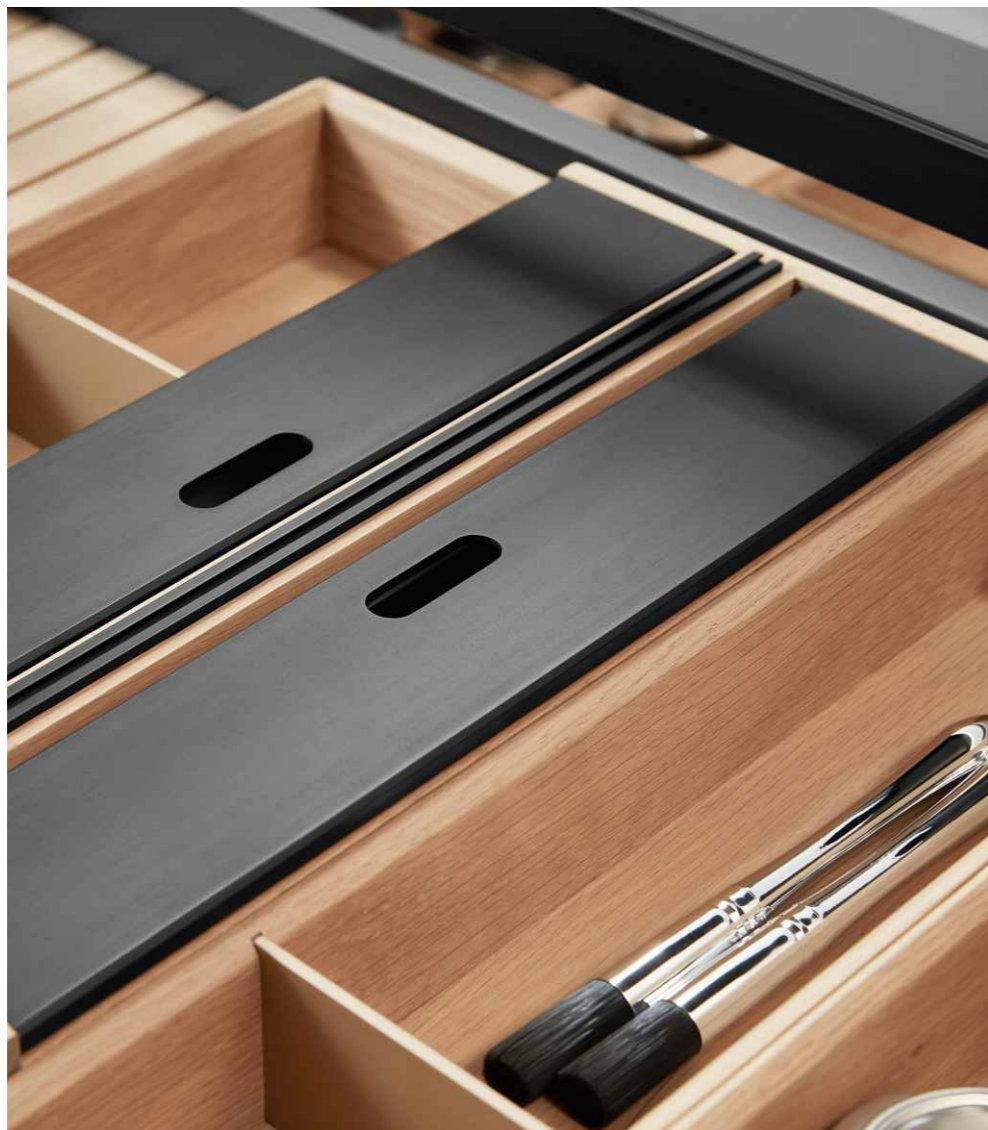

Spanning 6,800 kilometers,
Nordic logs were selected under strict quality standards.
JR Series drawer division system, White oak.





A Mechanical Piece Of Art
Mega Storage Space



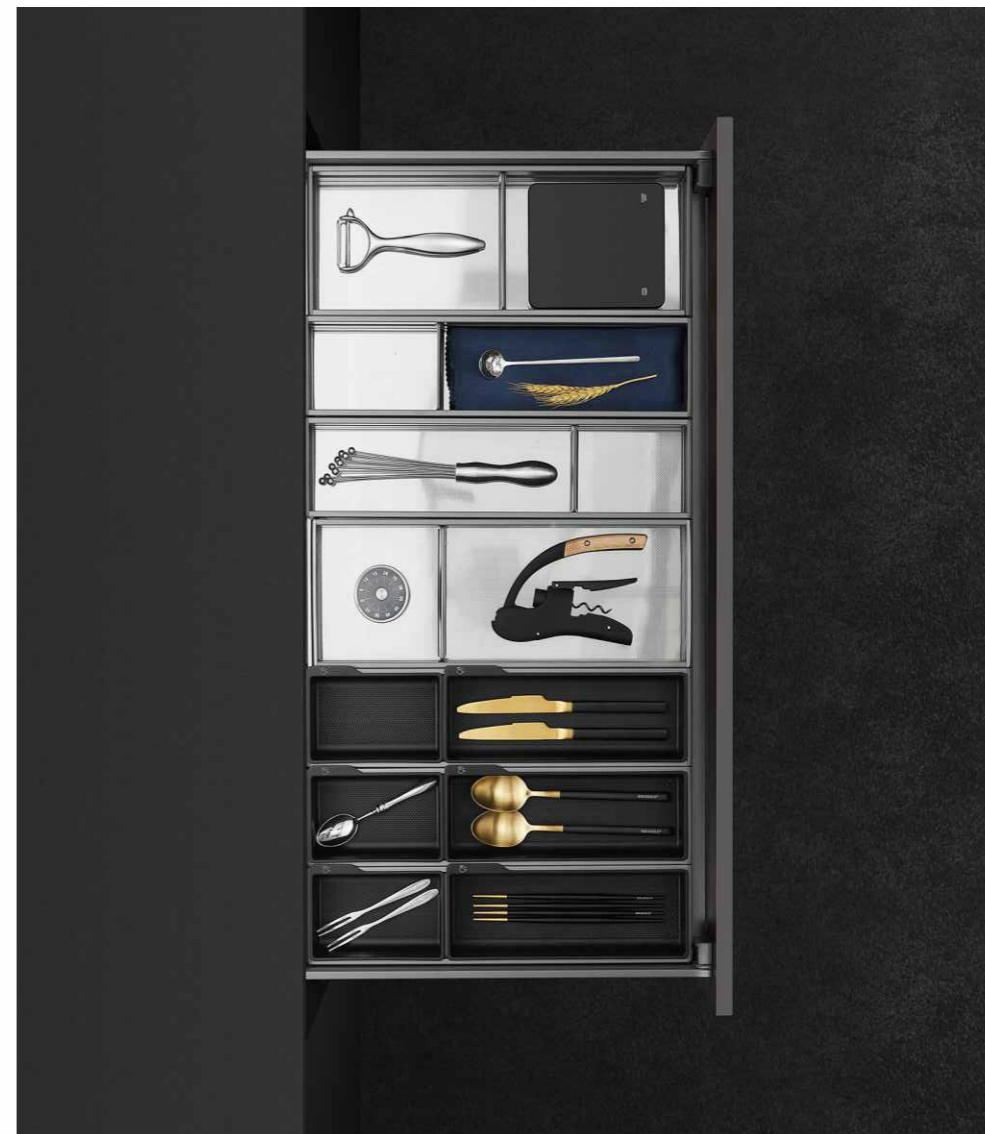











Jingran series Drawer divider system-
Aluminum

















Minimalist metal creates an infinitely stylish
aesthetic in the kitchen.

JING RAN





Jingran Sereis Drawer divider system - Single product

	ART.NO.	NAME	MATERIAL	W X D X H
	301051	Capsule coffee box	North American Black Walnut	150x422x10mm
	301052	knife block	North American Black Walnut	150x422x33mm
	301053	Plastic wrap box	North American Black Walnut	150x422x66mm
	301054	100 separator	North American Black Walnut	100x422x60mm
	301055	150 separator	North American Black Walnut	150x422x60mm
	301056	170 separator	North American Black Walnut	170x422x60mm
	301057	Seasoning container	North American Black Walnut	100x422x58mm
	301058	Grinder rack	North American Black Walnut	150x422x58mm
	301061	150 Cross divider	North American Black Walnut	150x422x48mm
	301062	150 T-type Cross divider	North American Black Walnut	150x422x43mm
	301063	150 U-type Cross divider	North American Black Walnut	150x422x48mm
	301064	200 U-type Cross divider	North American Black Walnut	200x422x48mm
	301065	250 U-type Cross divider	North American Black Walnut	250x422x48mm
	301066	300 U-type Cross divider	North American Black Walnut	300x422x48mm





	ART.NO.	NAME	MATERIAL	W X D X H
	301021	Capsule coffee box	European White Oak	150x422x10mm
	301022	knife block	European White Oak	150x422x33mm
	301023	Plastic wrap box	European White Oak	150x422x66mm
	301024	100 separator	European White Oak	100x422x60mm
	301025	150 separator	European White Oak	150x422x60mm
	301026	170 separator	European White Oak	170x422x60mm
	301027	Seasoning container	European White Oak	100x422x58mm
	301028	Grinder rack	European White Oak	150x422x58mm
	301031	150 Cross divider	European White Oak	150x422x48mm
	301032	150 T-type Cross divider	European White Oak	150x422x43mm
	301033	150 U-type Cross divider	European White Oak	150x422x48mm
	301034	200 U-type Cross divider	European White Oak	200x422x48mm
	301035	250 U-type Cross divider	European White Oak	250x422x48mm
	301036	300 U-type Cross divider	European White Oak	300x422x48mm

JING RAN







Jingran Sereis Drawer divider system - Single product

	ART.NO.	NAME	MATERIAL	W X D X H
	301071	100 Storage box	Aluminum+ABS	100x422x50mm
	301072	150 Storage box	Aluminum+ABS	150x422x50mm
	301073	200 Storage box	Aluminum+ABS	200x422x50mm
	301074	100 Large Tableware Storage box	ABS	99x260x53mm
	301075	100 Small Tableware Storage box	ABS	99x135x53mm

Jingran Sereis Drawer divider system - set

	ART.NO.	NAME	MATERIAL	W X D X H
	900mm	301094	Aluminum+ABS	800x415x50mm Drawer Net Width ≥ 810mm
	800mm	301093	Aluminum+ABS	700x415x50mm Drawer Net Width ≥ 710mm
	700mm	301092	Aluminum+ABS	600x415x50mm Drawer Net Width ≥ 610mm
	600mm	301091	Aluminum+ABS	500x415x50mm Drawer Net Width ≥ 510mm

Jingran Sereis Drawer divider system-set

	ART.NO.	NAME	MATERIAL	W X D X H
	900mm	301084	White oak	800x422x66mm Drawer Net Width ≥ 800mm
	900mm	301088	White oak	800x422x66mm Drawer Net Width ≥ 800mm
	800mm	301083	White oak	700x422x66mm Drawer Net Width ≥ 700mm
	800mm	301087	White oak	700x422x66mm Drawer Net Width ≥ 700mm
	700mm	301082	White oak	600x422x66mm Drawer Net Width ≥ 600mm
	700mm	301086	White oak	600x422x66mm Drawer Net Width ≥ 600mm
	600mm	301081	White oak	500x422x66mm Drawer Net Width ≥ 600mm



Aluminum combination



Black walnut combination



White oak combination

SHEARER THREE SIDES PULL OUT BASKET

Higold Shearer three sides pull out basket, through the optimization of product material, structure, aesthetic design, the storage space is subdivided and adjustable, to meet the needs of users to store a variety of kitchen utensils, experience the comfort and refreshing of a clean kitchen.

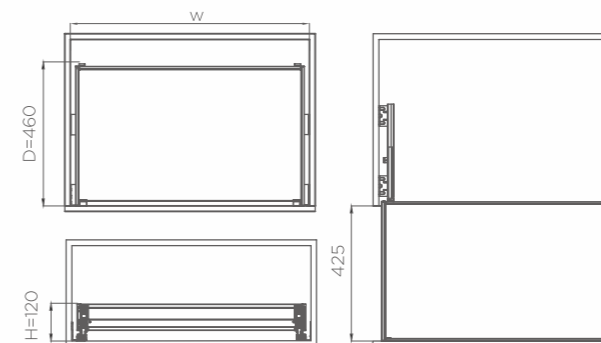

ART.NO	CABINET	W x D x H	MATERIAL	SURFACE	COLOR
303835	600mm	564x460x120mm	Aluminum	Nano-coating	Gray
303834	700mm	664x460x120mm	Aluminum	Nano-coating	Gray
303832	800mm	764x460x120mm	Aluminum	Nano-coating	Gray
303831	900mm	864x460x120mm	Aluminum	Nano-coating	Gray



Aluminum combination

Black walnut combination

White oak combination

SHEARER FOUR SIDES PULL OUT BASKET

Sinking 20mm to solve the problem of collision between the invisible handle and the dishes. Drawer in drawer design, well classified. Fully hidden slide, dust resistant and sliding smoother. Fish plate design, reasonable and more inclusive. Modular design, functional parts can be detachable, cleaning more convenient.

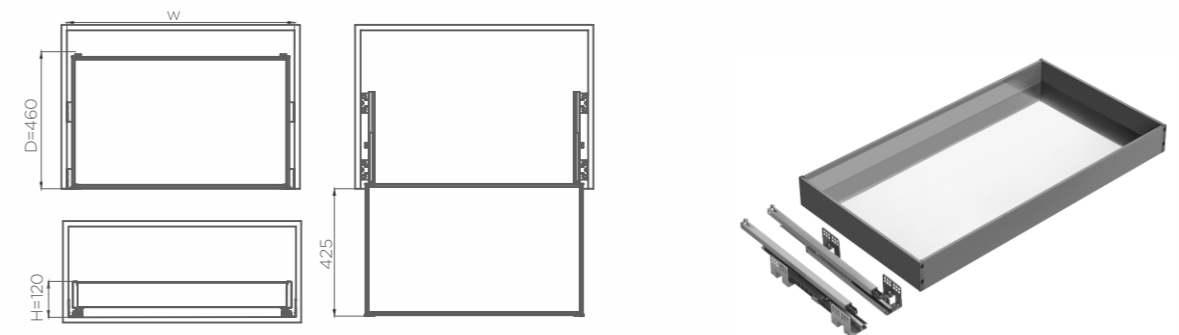

ART.NO	CABINET	W x D x H	MATERIAL	SURFACE	COLOR
301835	600mm	564x460x120mm	Aluminum	Nano-coating	Gray
301834	700mm	664x460x120mm	Aluminum	Nano-coating	Gray
301832	800mm	764x460x120mm	Aluminum	Nano-coating	Gray
301831	900mm	864x460x120mm	Aluminum	Nano-coating	Gray



**SHEARER STYLE
MINI PANTRY (UNIVERSAL MECHANISM)**

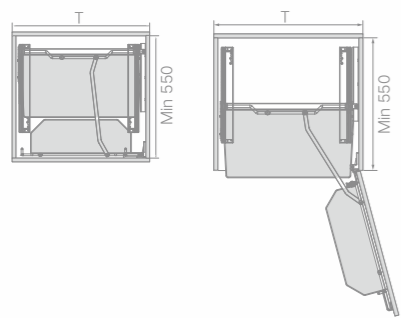

ART.NO	CABINET	WxDxH	MATERIAL	SURFACE
309041	600mm	550x490x590mm	Aluminum	Nano-coating



**SHEARER STYLE
TRAY BASKET (UNIVERSAL MECHANISM)**

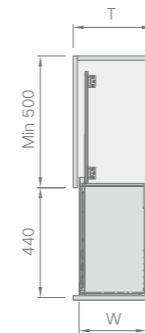

ART.NO	CABINET	W x D x H	MATERIAL	SURFACE	REMARK
304171	200mm	155X465X580mm	Aluminum	Nano-coating	2 Layers
304172	250mm	205X465X580mm	Aluminum	Nano-coating	2 Layers
304173	300mm	255X465X580mm	Aluminum	Nano-coating	2 Layers
304175	200mm	155x465x695mm	Aluminum	Nano-coating	3 Layers
304176	250mm	205x465x695mm	Aluminum	Nano-coating	3 Layers
304177	300mm	255x465x695mm	Aluminum	Nano-coating	3 Layers



SHEARER STYLE NARROW BASKET

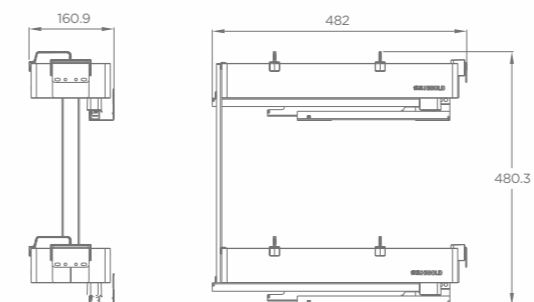

ART.NO	CABINET	W x D x H	MATERIAL	SURFACE	REMARK
304181	150mm	110X485X480mm	Aluminum	Nano-coating	Left installation
304182	150mm	110X485X480mm	Aluminum	Nano-coating	Right installation
304183	200mm	160X485X480mm	Aluminum	Nano-coating	Left installation
304184	200mm	160X485X480mm	Aluminum	Nano-coating	Right installation



CAPRI MID WAY SET

ART.NO	NAME	W x D x H	MATERIAL	ACCESSORIES MATERIAL	REMARK
403194	Hanging Rod	900x40x31.2mm	Aluminum Alloy	/	Nano Coating
	Hook	110x40x46mm	MS	/	Nano Coating
	Upper Shelf	280x105x12mm	MS	/	Nano Coating
	Tall Bottle Shelf	260x262x101mm	MS	/	Nano Coating
	Short Bottle Shelf	260x181x120mm	MS	ABS+Silica Gel	Nano Coating
	Knives Rack	220x262x52mm	MS	ABS	Nano Coating

Over All Size : 904x300x126mm

DIAMOND SERIES

Leading Design
Perfect Experience



DIAMOND TALL LARDER UNIT

fashion & Life

Give the kitchen a minimalist aesthetic

*

HIGOLD®





DIAMOND / SERIES

TALL LARDER UNITS

Patent NO.: ZL201922047348.7

Higold Platinum Tall Larder features a stylish, boldly innovative design, meeting the needs of large-capacity storage with high practicality. It stands as one of the standout products in Higold's kitchen storage hardware system. With smooth, seamless sliding and strict quality control from interior to exterior, it delivers a comfortable, durable storage experience. Meticulously crafted, it adds an extra touch of elegance to high-quality kitchen spaces.

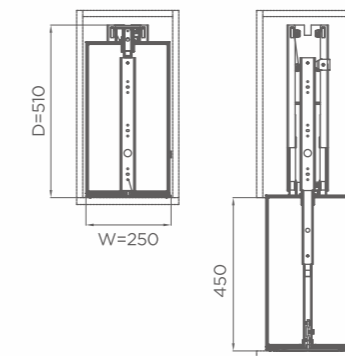

ART.NO	CABINET	W x D x H	MATERIAL	SURFACE	COLOR	REMARK
201122	300mm	250x510x(1659-2059)mm	Steel	Nano-coating	Gray	5 layers
201123	300mm	250x510x(1959-2359)mm	Steel	Nano-coating	Gray	6 layers
201125	400mm	350x510x(1659-2059)mm	Steel	Nano-coating	Gray	5 layers
201126	400mm	350x510x(1959-2359)mm	Steel	Nano-coating	Gray	6 layers

SWIVEL PULL OUT PANTRY

Convenient access,
linkage design

+

HIGOLD®



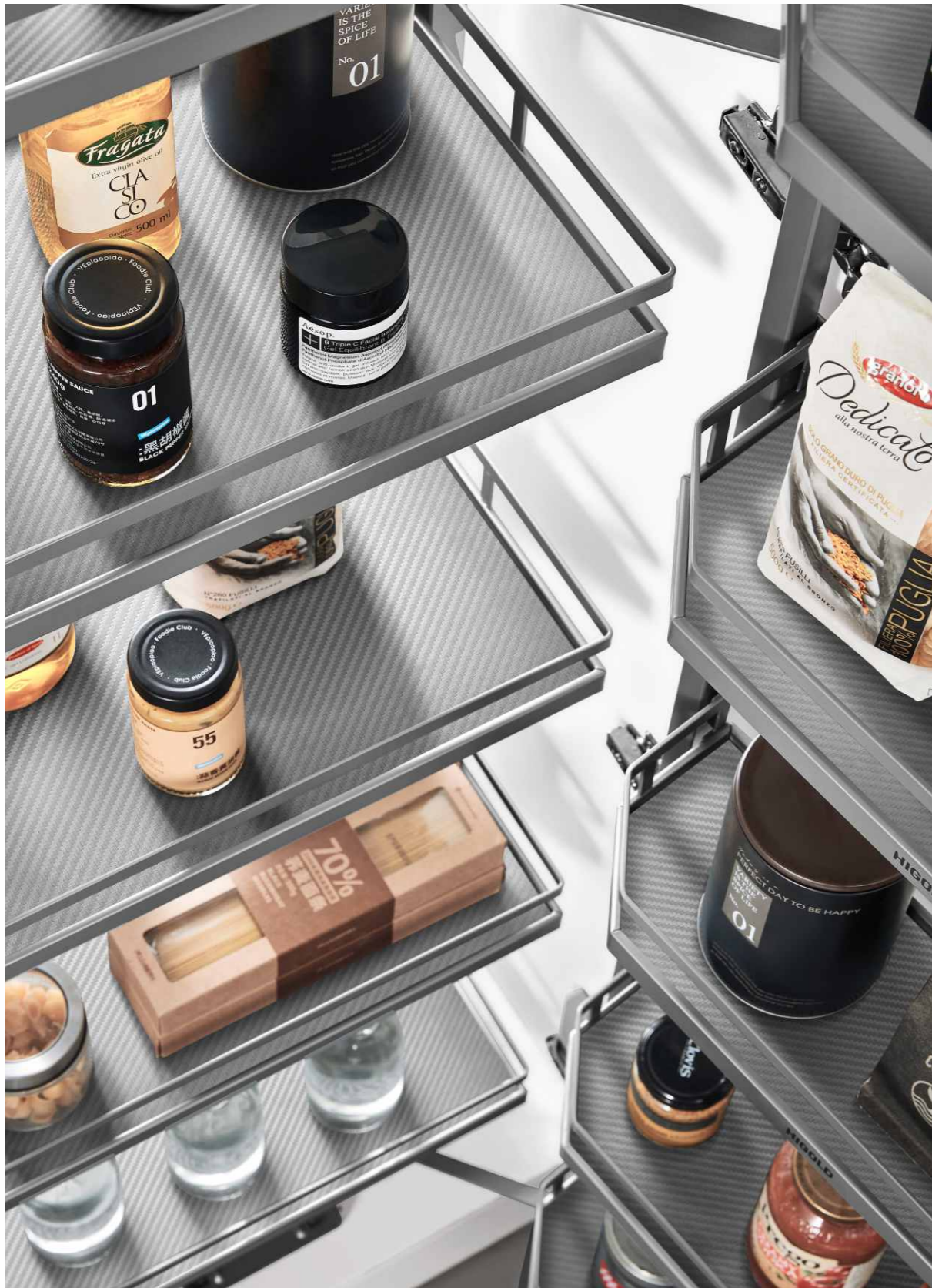

DIAMOND / SERIES

SWIVEL PULL OUT PANTRY

Patent NO.: ZL201920460643.2
Patent NO.: ZL202220774037.X

Higold Platinum Swivel Pul Out Pantry redefines kitchen storage: its multi-zone design keeps items neatly organized while the door-linked pull-out mechanism reveals every corner of the cabinet for easy access. Adjustable height levels adapt to various kitchen items, eliminating wasted space, and the intelligent engineering ensures a perfect fit for cabinets, blending functionality with sleek, space-saving design. Ideal for modern kitchens, it turns clutter into order with effortless usability.

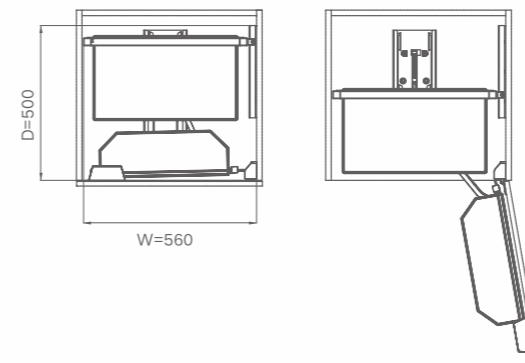

ART.NO	CABINET	W x D x H	MATERIAL	SURFACE	COLOR	REMARK
202262	450-500mm	410x500x1625mm	Steel	Nano-coating	Gray	5 layers
202263	450-500mm	410x500x1825mm	Steel	Nano-coating	Gray	6 layers
202265	600mm	560x500x1625mm	Steel	Nano-coating	Gray	5 layers
202266	600mm	560x500x1825mm	Steel	Nano-coating	Gray	6 layers



DIAMOND STYLE DISH AND BOWL LIET BASKET



ART.NO	CABINET	W x D x H	MATERIAL	SURFACE
401331	600mm	564x283x525mm	Steel	Nano-coating
401332	700mm	664x283x525mm	Steel	Nano-coating
401333	800mm	764x283x525mm	Steel	Nano-coating
401334	900mm	864x283x525mm	Steel	Nano-coating

SWING TRAYS 3.0

Aesthetic Storage,
Stylish Living





DIAMOND / SERIES

SWING TRAYS 3.0

Patent NO. : ZL202010424189.2
 Patent NO. : ZL202130385109.2

Higold Swing trays 3.0 innovates corner storage in both function and design. Its smooth flying-saucer shape cleverly slides out from the hidden space of the corner cabinet, and the 270° wide-angle view enables unobstructed access to items, showcasing a new strength in storage.

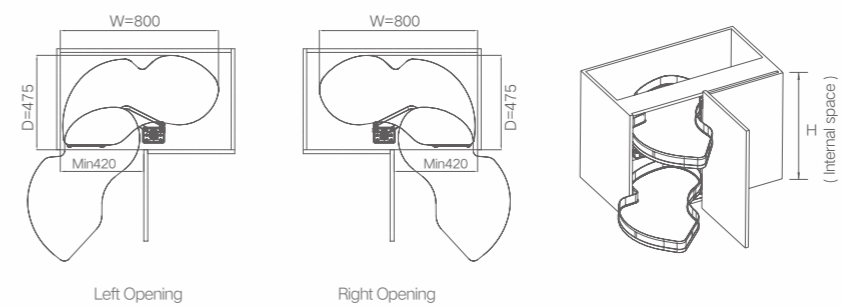

ART.NO	CABINET	W x D x H	MATERIAL	SURFACE	COLOR	REMARK
101071	≥900mm	800x475x(600-750)mm	Steel	Nano-coating	Gray	2 layers / left opening
101072	≥900mm	800x475x(600-750)mm	Steel	Nano-coating	Gray	2 layers / right opening

DIAMOND MAGIC CORNER

stable and clever
corner storage helper

The beauty
of industrial design!





DIAMOND / SERIES

DIAMOND MAGIC CORNER

Patent NO. : ZL202122637437.4
Patent NO. : ZL202122637501.9

The Higold Magic corner realizes a new kitchen storage experience of "I can get what I want", provides a kitchen solution that is both good-looking and usable, and makes the worthless space in kitchen more convenient and cool through the split-link design.

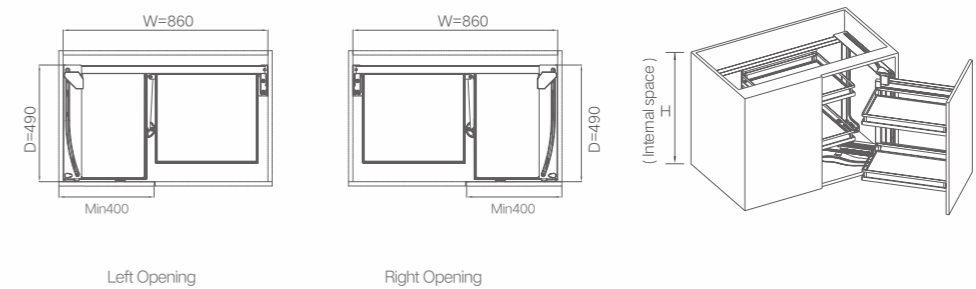

ART.NO	CABINET	W x D x H	MATERIAL	SURFACE	COLOR	REMARK
101035	≥900mm	860x490x535mm	Steel	Nano-coating	Gray	left opening
101036	≥900mm	860x490x535mm	Steel	Nano-coating	Gray	right opening



SHOW HAND MAGIC CORNER

The entire tray rotates out fully,
efficiently utilizing the corner space.



DIAMOND / SERIES

SHOW HAND MAGIC CORNER

Higold Show Hand Magic Corner breathes new life into the Higold corner storage system family. The full-extension design turns the corner from a "dead space" into a functional area. Four adjustable and partitioned baskets bring order and flexibility, revitalizing the kitchen corner storage with smart organization.

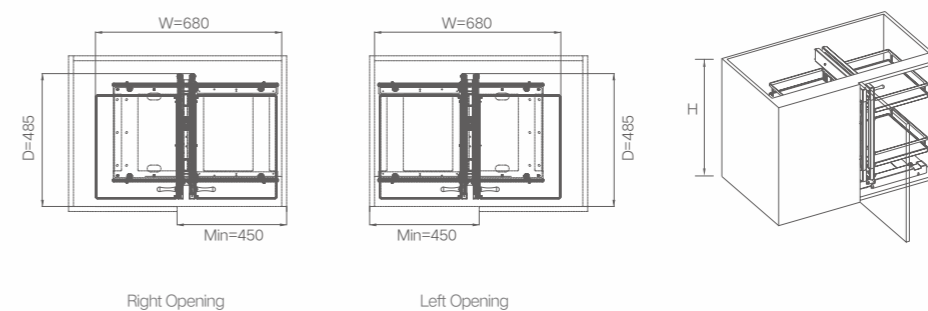

ART.NO	CABINET	W x D x H	MATERIAL	SURFACE	COLOR	REMARK
101125	≥800mm	680x485x590mm	Steel	Nano-coating	Gray	universal opening



STARRY BASE UNITS





STARRY / SERIES

STARRY THREE SIDE MULTI- PURPOSE BASKET (TWO BASKETS)

Higold Starry series pull baskets achieve a balance between professionalism and freedom, making the design more warm. The flat baskets of each layer of bowl baskets are universal, and the layout can be freely adjusted according to different storage habits without the need to reassemble. Humanized partition layout, compatible with small pendants and large oil drums, so that every item has a place to belong.

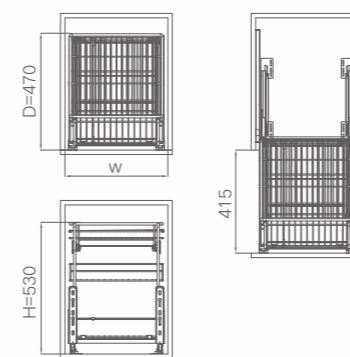

ART.NO	CABINET	W x D x H	MATERIAL	SURFACE
303661	600mm	564x440x180mm	SS 201	Electrolysis
303662	700mm	664x440x180mm	SS 201	Electrolysis
303664	800mm	764x440x180mm	SS 201	Electrolysis
303665	900mm	864x440x180mm	SS 201	Electrolysis



STARRY SERIES SEASONING PULL OUT BASKET

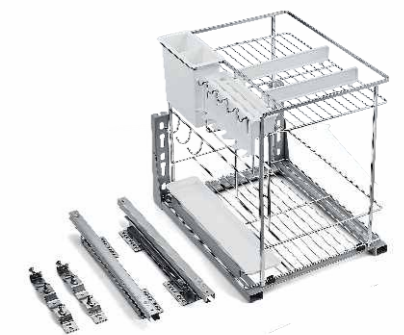
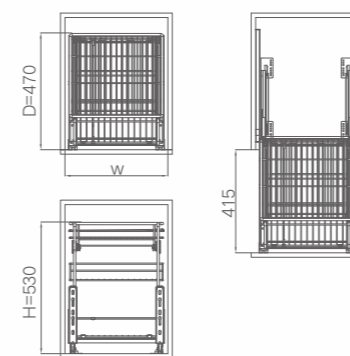

ART.NO	CABINET	W x D x H	MATERIAL	SURFACE
306191	300mm	264x420x465mm	SS + PP plastic	Electrolysis
306192	350mm	314x420x465mm	SS + PP plastic	Electrolysis
306193	400mm	364x420x465mm	SS + PP plastic	Electrolysis
306194	450mm	414x420x465mm	SS + PP plastic	Electrolysis



DIAMOND STYLE SIDE BASKET

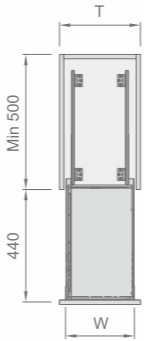

ART.NO	CABINET	W x D x H	MATERIAL	REMARK
304161	150mm	105x462x580mm	Steel	Soft Close / Universal Opening
304162	200mm	155x462x580mm	Steel	Soft Close / Universal Opening
304163	250mm	205x462x580mm	Steel	Soft Close / Universal Opening
304164	300mm	255x462x580mm	Steel	Soft Close / Universal Opening



DIAMOND STYLE SIDE BASKET

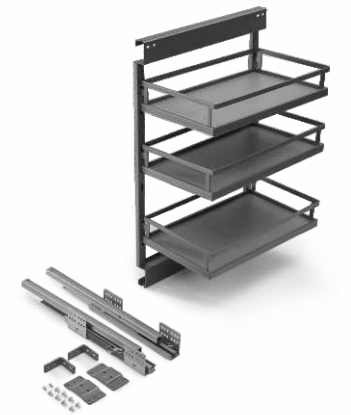
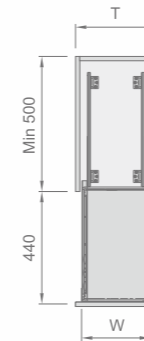

ART.NO	CABINET	W x D x H	MATERIAL	REMARK
304151	150mm	105x462x695mm	Steel	Soft Close / Universal Opening
304152	200mm	155x462x695mm	Steel	Soft Close / Universal Opening
304153	250mm	205x462x695mm	Steel	Soft Close / Universal Opening
304154	300mm	255x462x695mm	Steel	Soft Close / Universal Opening

(Wire basket optional)



**DIAMOND
2.0
BASE
UNITS**

Leading design
perfect experience

DIAMOND 2.0 PULL OUT MULTI PURPOSE FOUR SIDES BASKET

Cupboard features a spacious basin area capable of accommodating various tableware, with a load-bearing capacity of up to 30 kg. This allows family members to store items effortlessly without worry of breakage. The separate compartments for bowls and plates facilitate organization, enhancing both safety and aesthetic appeal.

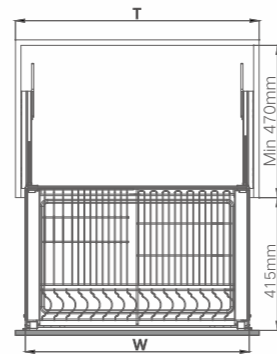

ART.NO	CABINET	W x D x H	MATERIAL	SURFACE
301501S	600mm	564x466x189mm	Steel	Nano-coating
301502S	700mm	664x466x189mm	Steel	Nano-coating
301504S	800mm	764x466x189mm	Steel	Nano-coating
301505S	900mm	864x466x189mm	Steel	Nano-coating

DIAMOND 2.0 PULL OUT FOUR SIDES BASKET

Boasting a flat, spacious design that maximizes storage space, the Diamond 2.0 Pot Stand features a convenient U-shaped opening for easy access. It offers versatile mounting options with open or pull-out wings, all included with complete installation accessories.

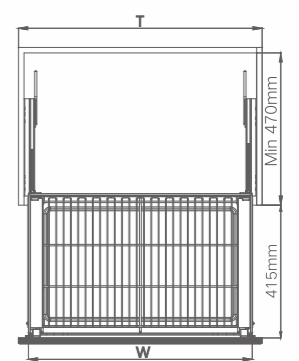

ART.NO	CABINET	W x D x H	MATERIAL	SURFACE
301511S	600mm	564x466x189mm	Steel	Nano-coating
301512S	700mm	664x466x189mm	Steel	Nano-coating
301514S	800mm	764x466x189mm	Steel	Nano-coating
301515S	900mm	864x466x189mm	Steel	Nano-coating



DIAMOND 2.0 / SERIES

DIAMOND 2.0 SEASONING PULL OUT BASKET

Knife and spice rack integrates multiple essential kitchen functions. The shelf accommodates various spices and condiment bottles of different sizes. The built-in knife box and utensil holder are easily removable for convenient and hygienic maintenance. The noise-dampening glide mechanism ensures smooth and quiet closing, providing users with a comfortable experience.

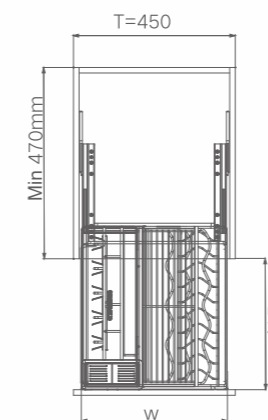

ART.NO	CABINET	W x D x H	MATERIAL	SURFACE
306034S	300 mm	264x465x465mm	Steel	Nano-coating
306035S	350 mm	314x465x465mm	Steel	Nano-coating
306043S	400 mm	364x465x465mm	Steel	Nano-coating
306052S	450 mm	414x465x465mm	Steel	Nano-coating



FASHION SERIES

Simple, Convenient,
Pleasing Experience



FASHION STYLE SOFT CLOSE TALL UNIT

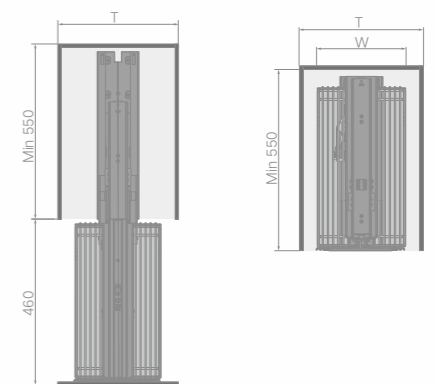

ART.NO	CABINET	W x D x H	MATERIAL	SURFACE	REMARK
201102	300mm	250x510x(1659-2059)mm	Steel	Nano coating	5 Layers
201103	300mm	250x510x(1959-2359)mm	Steel	Nano coating	6 Layers
201105	400mm	350x510x(1659-2059)mm	Steel	Nano coating	5 Layers
201106	400mm	350x510x(1959-2359)mm	Steel	Nano coating	6 Layers



FASHION STYLE SWIVEL TANDEM PANTRY

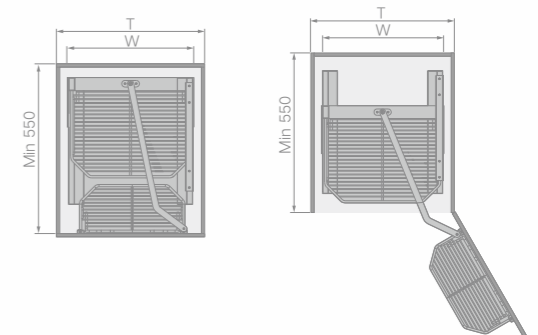

ART.NO	CABINET	W x D x H	MATERIAL	SURFACE	REMARK
202002	450/500mm	385x530x(1659-2059)mm	Steel	Nano coating	5 Layers
202003	450/500mm	385x530x(1959-2359)mm	Steel	Nano coating	6 Layers
202005	600mm	485x530x(1659-2059)mm	Steel	Nano coating	5 Layers
202006	600mm	485x530x(1959-2359)mm	Steel	Nano coating	6 Layers



**FASHION STYLE
SS DRAINING RACK**

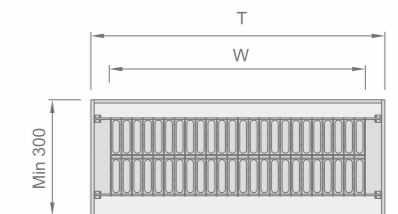

ART.NO	CABINET	W x D x H	MATERIAL	SURFACE
401070	600mm	565x250x(100+45)mm	SS 201 / 304	Chrome plating
401071	700mm	665x250x(100+45)mm	SS 201 / 304	Chrome plating
401072	800mm	765x250x(100+45)mm	SS 201 / 304	Chrome plating
401073	900mm	865x250x(100+45)mm	SS 201 / 304	Chrome plating

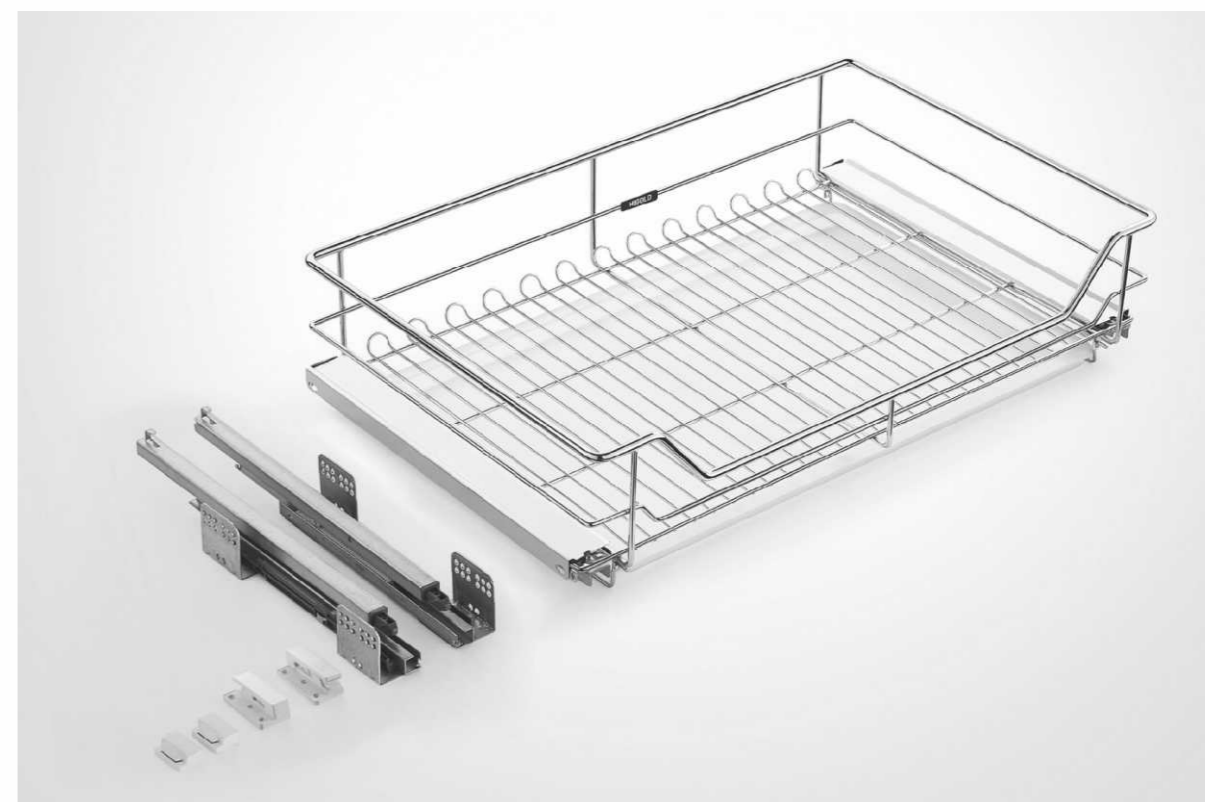

**FASHION STYLE
FOUR SIDE PULL OUT
BASKET**

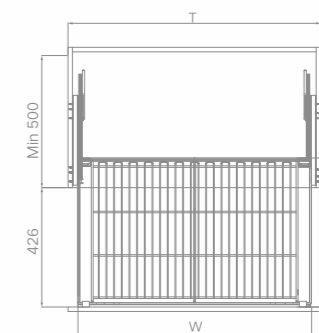

ART.NO	CABINET	W x D x H	MATERIAL	SURFACE	REMARK
301001	400mm	294x450x143mm	Steel	Nano coating	16 inch
301002	450mm	344x450x143mm	Steel	Nano coating	16 inch
301004	600mm	494x450x143mm	Steel	Nano coating	18 inch
301101	700mm	630x465x133mm	Steel	Nano coating	18 inch
301102	800mm	680x465x133mm	Steel	Nano coating	18 inch
301103	900mm	730x465x133mm	Steel	Nano coating	18 inch



FASHION STYLE SOFT CLOSE MAGIC CORNER

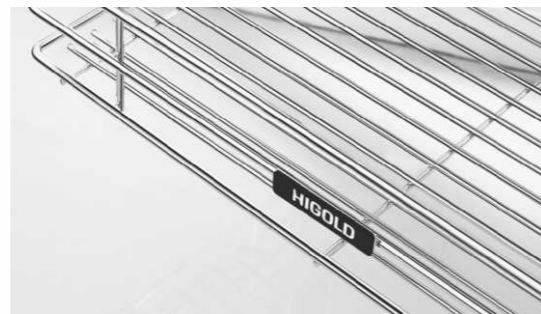
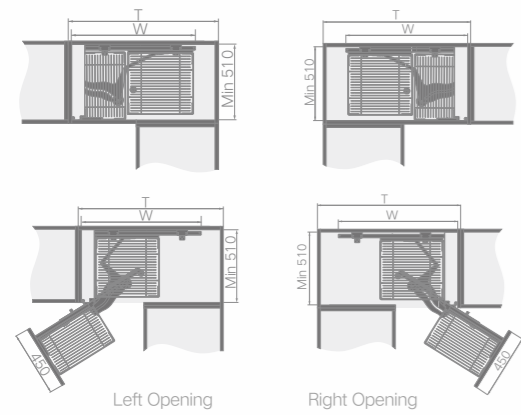

ART.NO	CABINET	W x D x H	MATERIAL	SURFACE	REMARK
101005	900mm	860x490x535mm	Steel	Nano coating	Left Opening
101006	900mm	860x490x535mm	Steel	Nano coating	Right Opening

FASHION STYLE SOFT CLOSE SHOW HAND CORNER

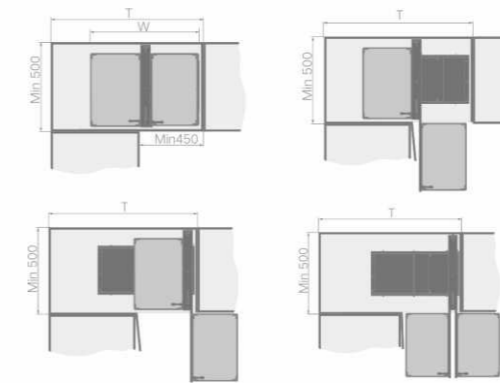

ART.NO	CABINET	W x D x H	MATERIAL	SURFACE	REMARK
101011	800/900mm	680x485x590mm	Steel	Nano coating	Universal Opening

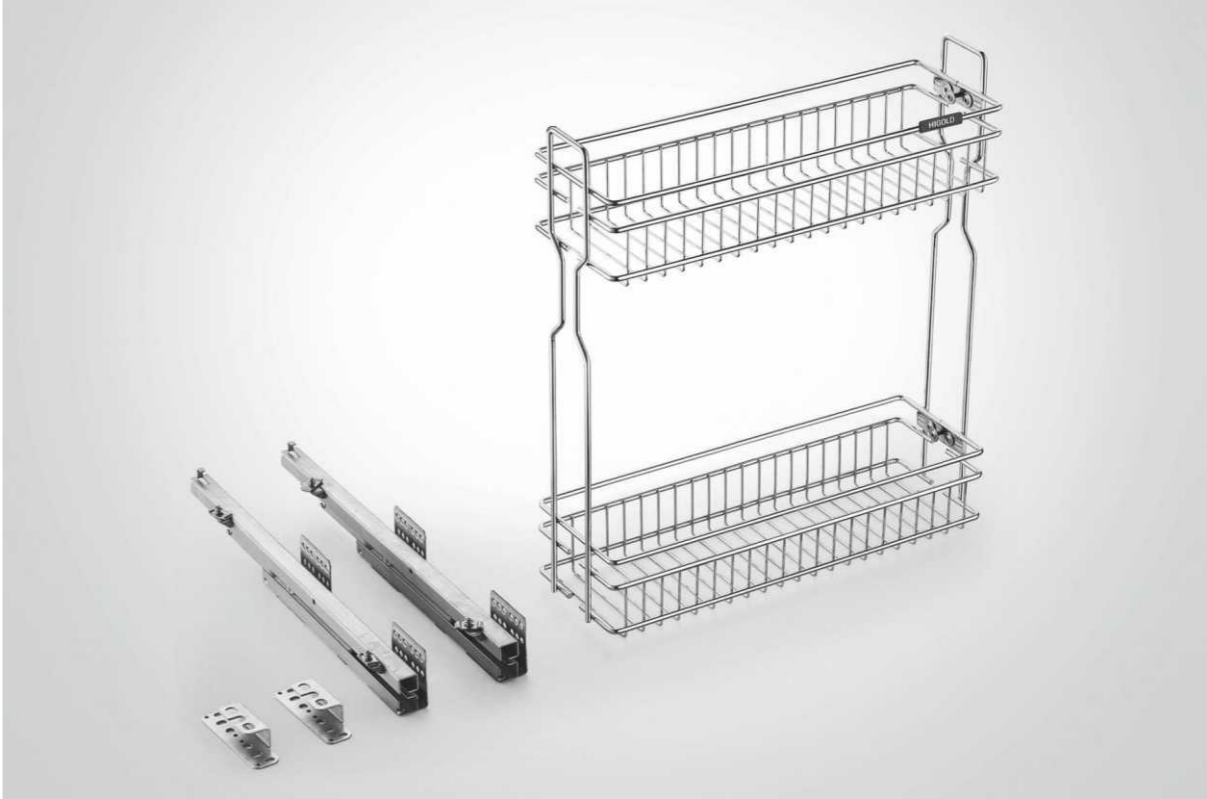

**FASHION STYLE
NARROW BASKET**

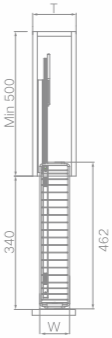

ART.NO	CABINET	W x D x H	MATERIAL	SURFACE	REMARK
304098	150mm	110x460x490mm	Steel	Nano coating	left/right side
304099	200mm	160x460x490mm	Steel	Nano coating	left/right side



FASHION STYLE BASE BASKET

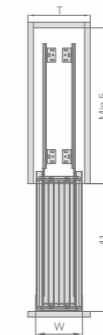

ART.NO	CABINET	W x D x H	MATERIAL	SURFACE
304084	150mm	100x450x520mm	Steel	Nano coating
304081	200mm	150x450x520mm	Steel	Nano coating
305001	300mm	235x450x520mm	Steel	Nano coating

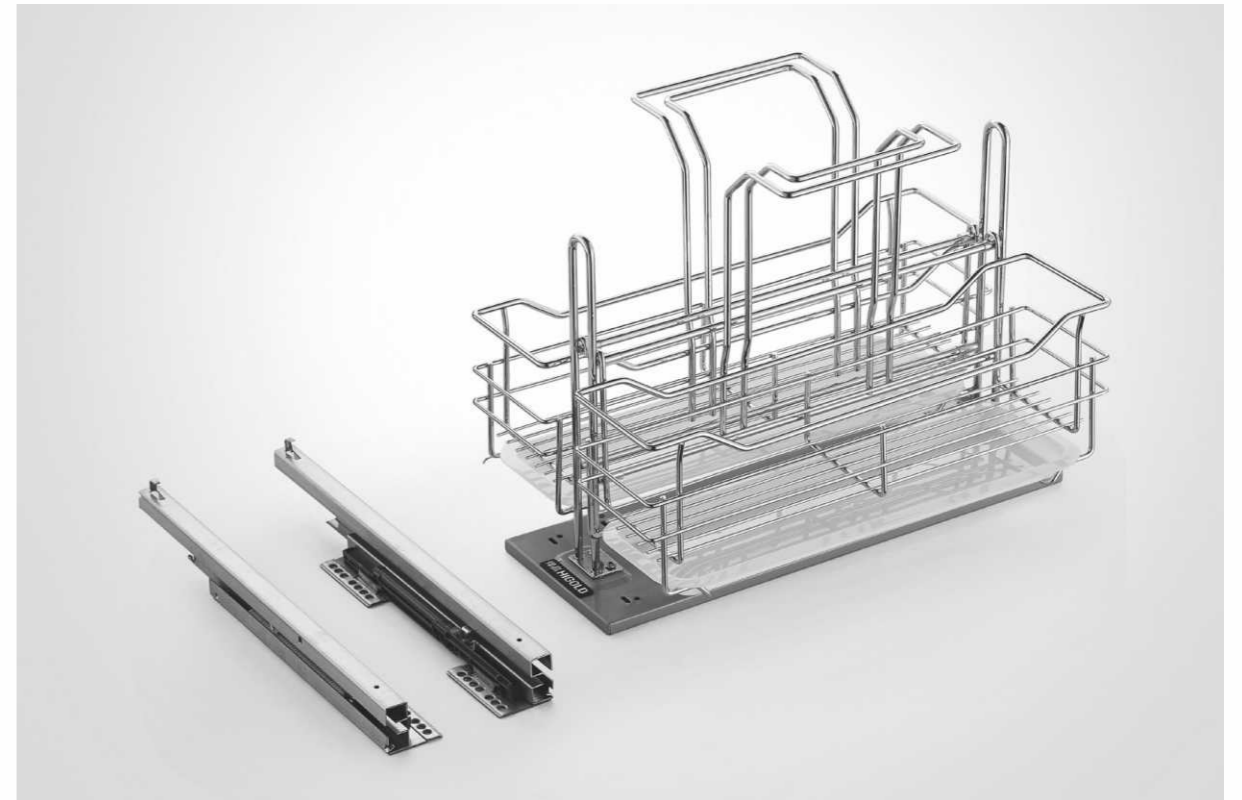

**FASHION STYLE
CLEAR-LIQUID RACK**

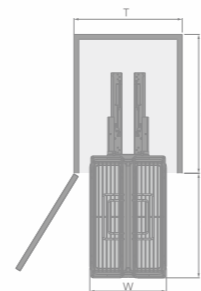

ART.NO	CABINET	W x D x H	MATERIAL	SURFACE
307020	350mm	314x465x405mm	Steel	Nano coating

PLATINUM 2.0 BASE UNITS

Receiving Life
More Imagination





PLATINUM 2.0 PULL OUT MULTI PURPOSE BASKET

Line reconstruction, space renewal. The structure has been completely upgraded. There are no restrictions on the storage form, The hidden flat-welded structure design is suitable for both vertical and horizontal storage.

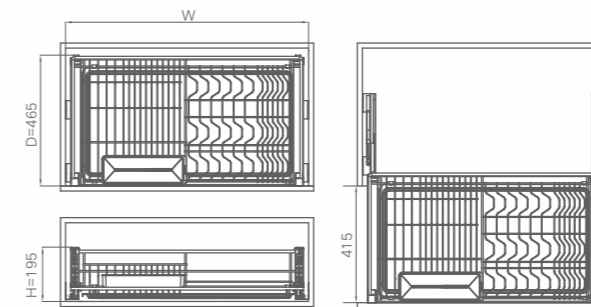

Patent NO.: ZL202230562498.6
Patent NO.: ZL202230562901.5
Patent NO.: ZL201521116688.6

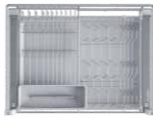
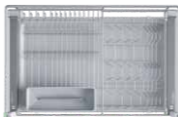
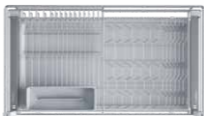
	ART.NO	CABINET	W x D x H	MATERIAL	SURFACE	COLOR
	303605S	600mm	564x465x195mm	Steel	Nano-coating	Metallic grey
	303601S	700mm	664x465x195mm	Steel	Nano-coating	Metallic grey
	303602S	800mm	764x465x195mm	Steel	Nano-coating	Metallic grey
	303603S	900mm	864x465x195mm	Steel	Nano-coating	Metallic grey

Remarks: The pull-out basket is equipped with channels, screws and other mounting accessories.



PLATINUM2.0 / SERIES

PLATINUM 2.0 PULL OUT BASKET

Simple line large flat basket, freely put without restrictions. The minimalist design leaves the maximum storage space, allowing users to experience convenient storage and making the kitchen environment neater.

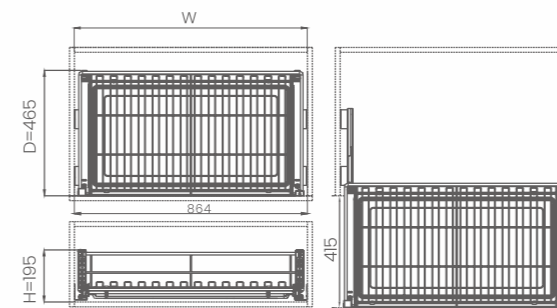

ART.NO	CABINET	W x D x H	MATERIAL	SURFACE	COLOR
303695S	600mm	564x465x195mm	Steel	Nano-coating	Metallic grey
303694S	700mm	664x465x195mm	Steel	Nano-coating	Metallic grey
303692S	800mm	764x465x195mm	Steel	Nano-coating	Metallic grey
303691S	900mm	864x465x195mm	Steel	Nano-coating	Metallic grey

PLATINUM 2.0 PRO BASE UNITS

HIGOLD®

Original Design & Quality



PLATINUM 2.0 PRO

Detachable modular design for effortless and efficient cleaning.

Upgraded Pro-level capacity with an added cutlery tray, increasing space efficiency by 30%.
Wave-style rack securely holds plates and bowls of various sizes, ensuring smooth and safe gliding.
Detachable functional module components, making it more convenient to use and clean.

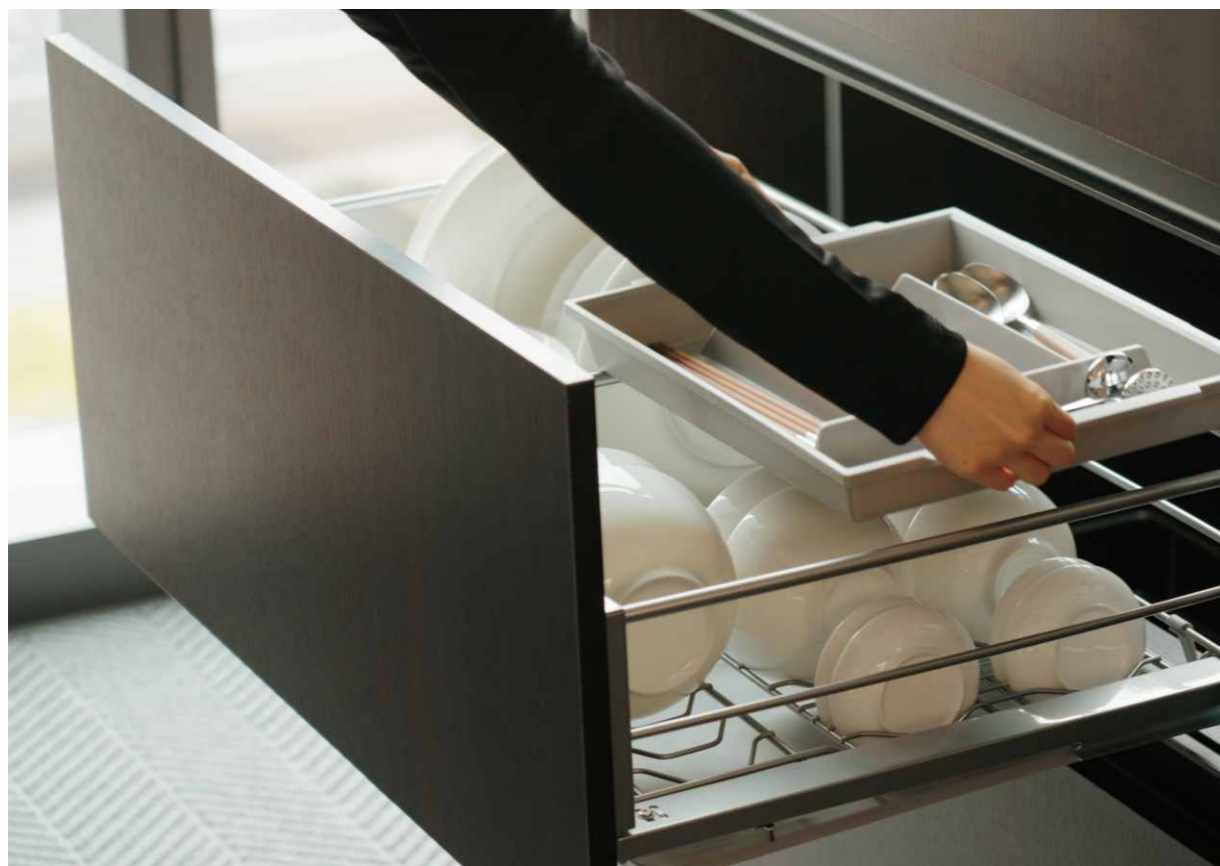



PLATINUM 2.0 PRO PULL OUT MULTI PURPOSE BASKET

Even if it accommodates many cutlery, it remains flexible and orderly. Higold Platinum 2.0Pro dishes & bowl basket ingeniously adds a storage area for tableware in the vertical direction, the space utilization rate has increased by 30%, and the practicality rate has doubled.

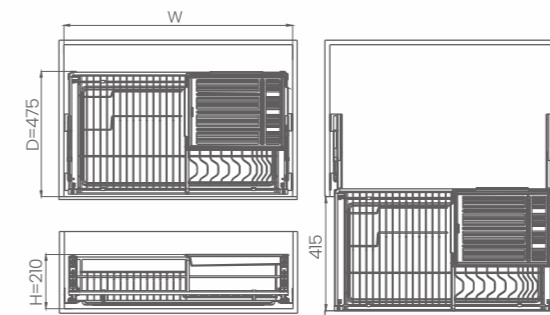

Patent NO. : ZL202230562498.6
Patent NO. : ZL202230562901.5
Patent NO. : ZL201521116688.6

	ART.NO	CABINET	W x D x H	MATERIAL	SURFACE	COLOR
	303121	600mm	564x475x210mm	Steel	Nano-coating	Metallic grey
	303122	700mm	664x475x210mm	Steel	Nano-coating	Metallic grey
	303124	800mm	764x475x210mm	Steel	Nano-coating	Metallic grey
	303125	900mm	864x475x210mm	Steel	Nano-coating	Metallic grey

Remarks: The pull-out basket is equipped with channels, screws and other mounting accessories.



PLATINUM 2.0 BASE UNITS

SEASONING
PULL OUT BASKET

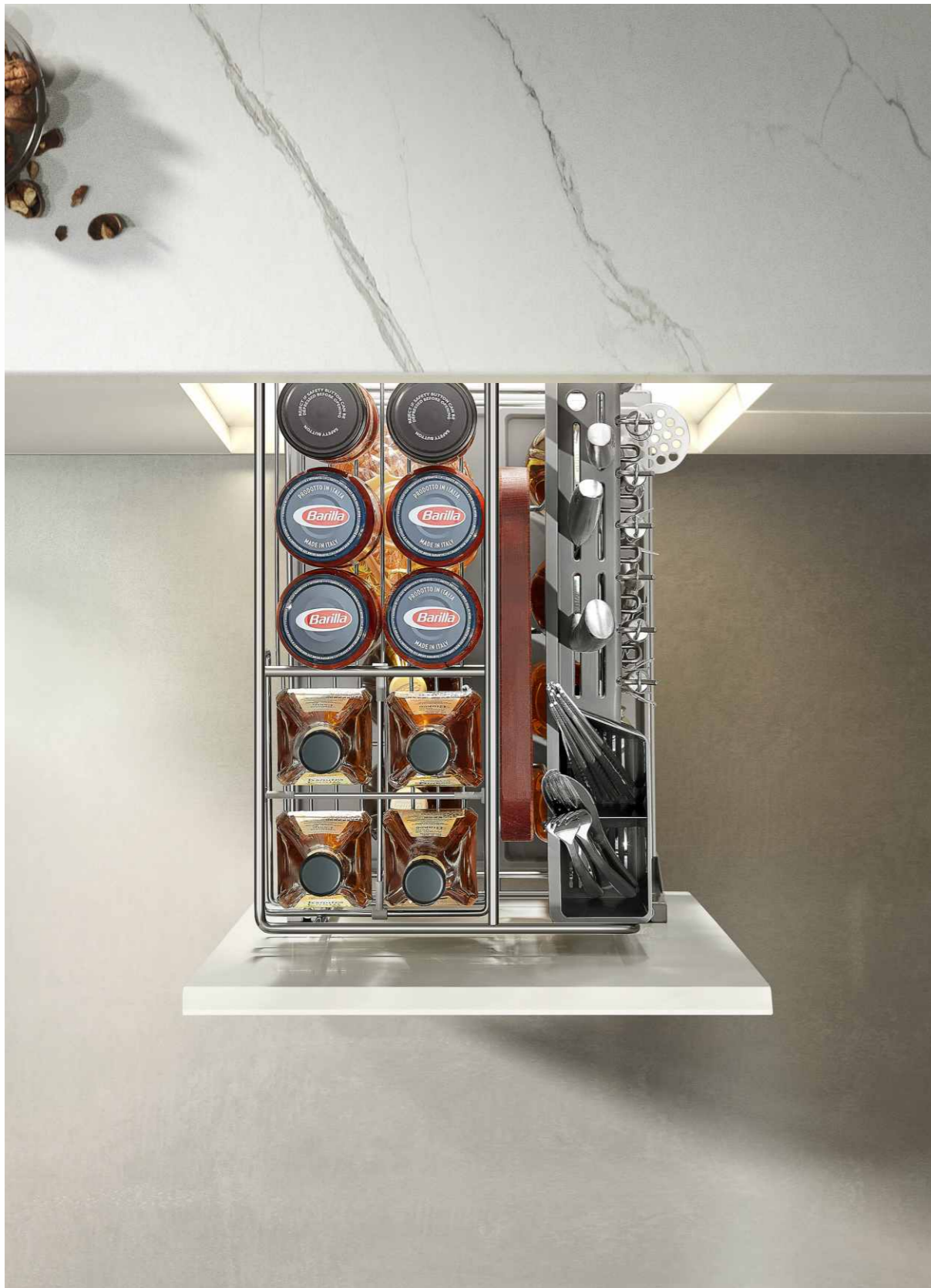





PLATINUM2.0 / SERIES

PLATINUM2.0 SEASONING PULL OUT BASKET

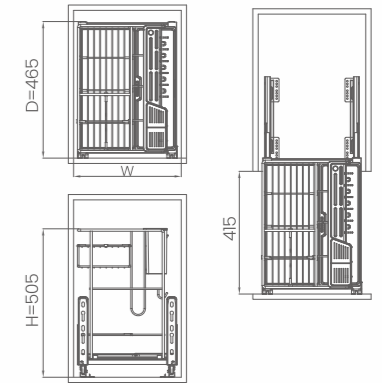
Patent NO.: ZL202230562498.6
 Patent NO.: ZL202230562901.5
 Patent NO.: ZL201521116688.6

The cooking utensils are all in full view, The brand-new height offset structure meets the storage needs of different heights, and all kinds of bottles and cans of different heights are included. Upgrade to large-area PP trays, ensuring that residual liquids can escape seamlessly and keeping the cabinets dry and tidy. Reasonable storage design, endowing everything with storage the seasoning space allows users to cook comfortably.



	ART.NO	CABINET	W x D x H	MATERIAL	SURFACE	COLOR
	306031S	300mm	264x465x505mm	Steel	Nano-coating	Metallic grey
	306021S	350mm	314x465x505mm	Steel	Nano-coating	Metallic grey
	306041S	400mm	364x465x505mm	Steel	Nano-coating	Metallic grey
	306051S	450mm	414x465x505mm	Steel	Nano-coating	Metallic grey

Remarks: The pull-out basket is equipped with channels, screws and other mounting accessories.



MARTIN 2.0 BASE UNITS

Space interpretation, refreshed.

HIGOLD®



MARTIN 2.0 PULL OUT MULTI PURPOSE BASKET

Martin 2.0 pul basket adopts fashionable high-end design, reflecting the artistic aesthetics of the basket body.



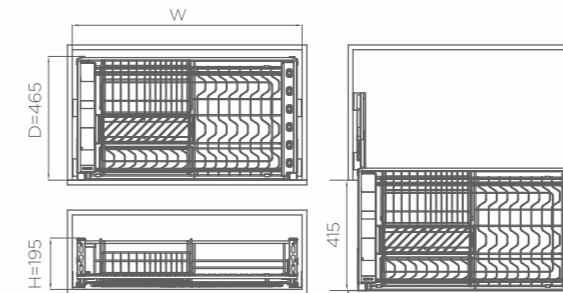

Separable detachable tray design allows users to independently take out the tray and store the dishes.

After putting away the cutlery, the user can put the tray back on the basket as a whole.

The new design allows the basket to increase the storage space of dishes, making storage more convenient and practical.



Patent NO.: ZL202230602487.6
Patent NO.: ZL202230602487.6
Patent NO.: ZL202230562487.8

	ART.NO	CABINET	W x D x H	MATERIAL	SURFACE	COLOR
	303401S	600mm	564x465x195mm	Steel	Nano-coating	Metallic grey
	303402S	700mm	664x465x195mm	Steel	Nano-coating	Metallic grey
	303404S	800mm	764x465x195mm	Steel	Nano-coating	Metallic grey
	303405S	900mm	864x465x195mm	Steel	Nano-coating	Metallic grey

Remarks: The pull-out basket is equipped with channels, screws and other mounting accessories.



MARTIN 2.0 / SERIES

MARTIN 2.0 PULL OUT BASKET

Patent NO. : ZL202230602487.6
 Patent NO. : ZL202230602487.6
 Patent NO. : ZL202230562487.8

Visualize the large flat basket for more free storage. It can store large pots, small appliances, and special-shaped tableware, which are more suitable for special kitchenware storage; nano coating technology, which refuses rust and is durable.

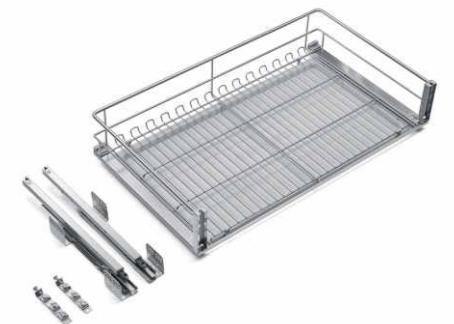
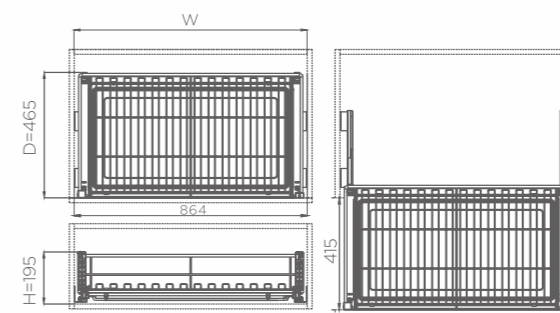

ART.NO	CABINET	W x D x H	MATERIAL	SURFACE	COLOR
303695S	600mm	564x465x195mm	Steel	Nano-coating	Metallic grey
303694S	700mm	664x465x195mm	Steel	Nano-coating	Metallic grey
303692S	800mm	764x465x195mm	Steel	Nano-coating	Metallic grey
303691S	900mm	864x465x195mm	Steel	Nano-coating	Metallic grey



MARTIN 2.0
SEASONING PULL OUT BASKET

The refined structural design allows the accessories to be removed separately, making it more convenient to use







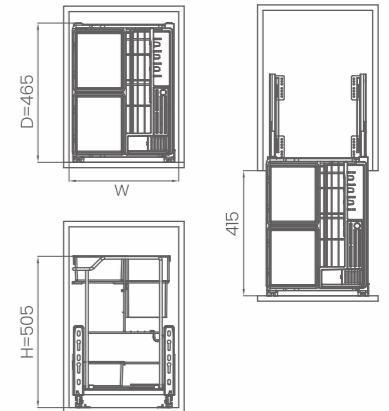

MARTIN 2.0 SEASONING PULL OUT BASKET

Patent NO.: ZL202230602487.6
 Patent NO.: ZL202230602487.6
 Patent NO.: ZL202230562487.8

Smart storage, dynamic interpretation. Reorganize the storage layout to make the space more flexible. Flexible storage boxes for easy movement and placement, kitchenware. Handle it with ease. The high and low offset design, the full three-dimensional storage space, and the ingenious orderly zoning for storage make it easy to find immediately when you open it.



	ART.NO	CABINET	W x D x H	MATERIAL	SURFACE	COLOR
	306091S	300mm	264x465x505mm	Steel	Nano-coating	Metallic grey
	306092S	350mm	314x465x505mm	Steel	Nano-coating	Metallic grey
	306093S	400mm	364x465x505mm	Steel	Nano-coating	Metallic grey
	306094S	450mm	414x465x505mm	Steel	Nano-coating	Metallic grey

Remarks: The pull-out basket is equipped with channels, screws and other mounting accessories.

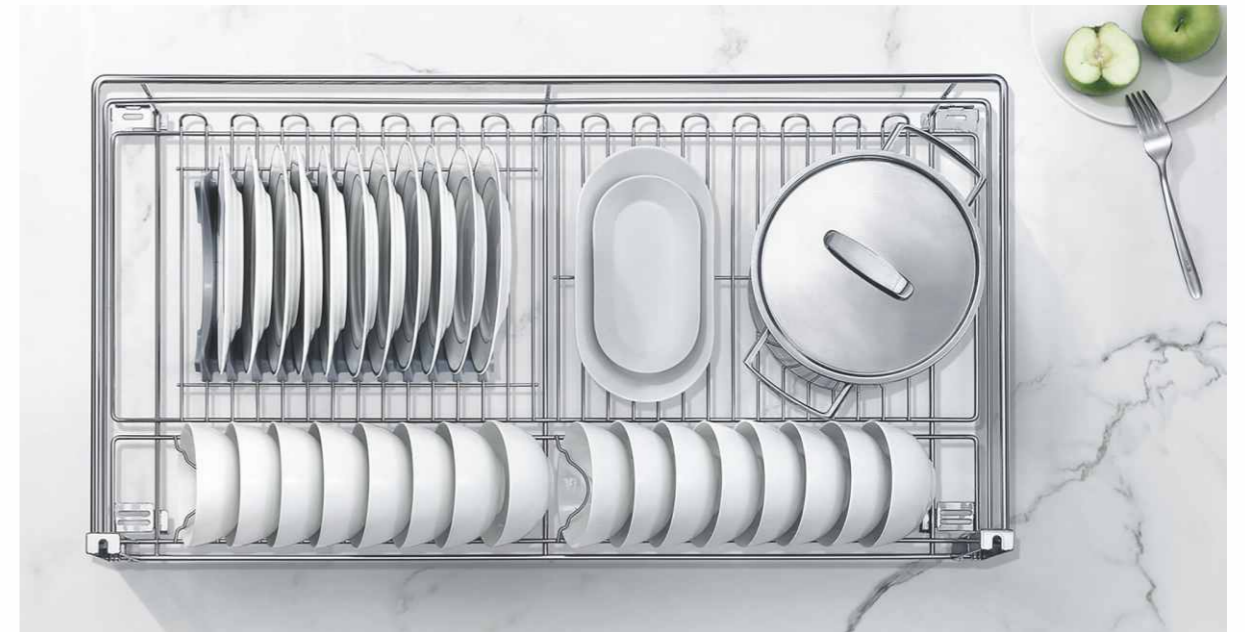

**M SEREIS
PULL OUT BASKET (TWO BASKET)**

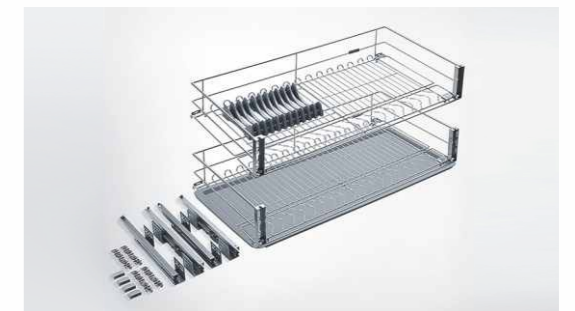
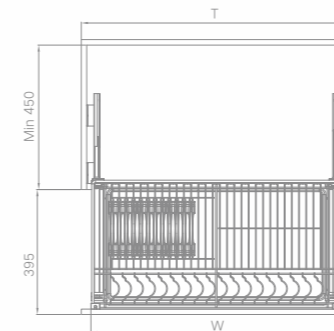

ART.NO	CABINET	W x D x H	MATERIAL	SURFACE
303271	600mm	564x440x180mm	Steel	Nano-coating
303272	700mm	664x440x180mm	Steel	Nano-coating
303274	800mm	764x440x180mm	Steel	Nano-coating
303275	900mm	864x440x180mm	Steel	Nano-coating



M SEREIS MULTI PURPOSE BASKET

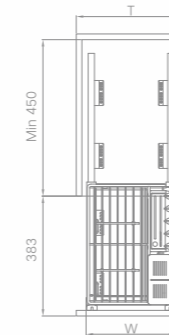

ART.NO	CABINET	W x D x H	MATERIAL	SURFACE
306181	300mm	264x420x465mm	Steel	Nano-coating
306182	350mm	314x420x465mm	Steel	Nano-coating
306183	400mm	364x420x465mm	Steel	Nano-coating
306184	450mm	386x420x465mm	Steel	Nano-coating



S.S. WASTEBIN

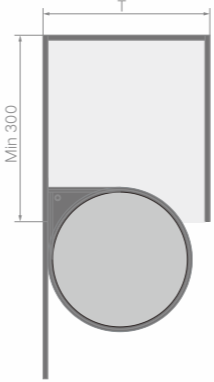

ART.NO	CABINET	W x D x H	MATERIAL	REMARK
307015	350mm	Ø260xH315mm	SS 201	8L
307016	450mm	Ø290xH350mm	SS 201	14L



UNDER SINK WASTEBIN

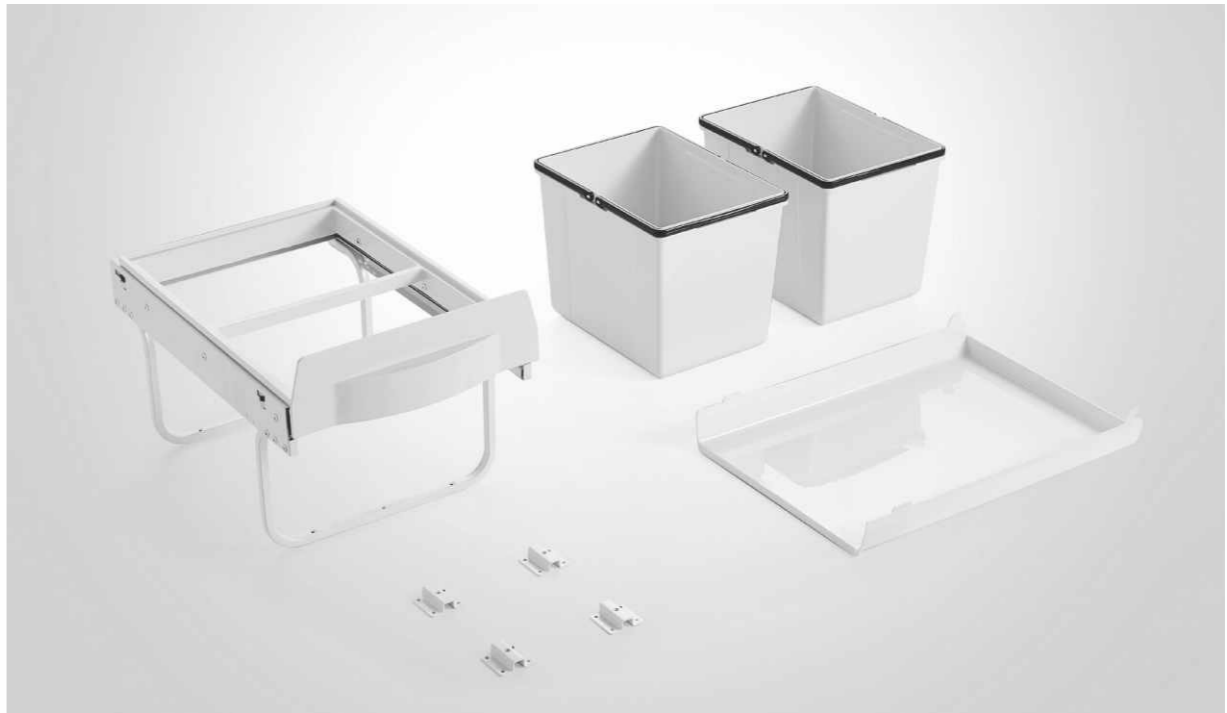
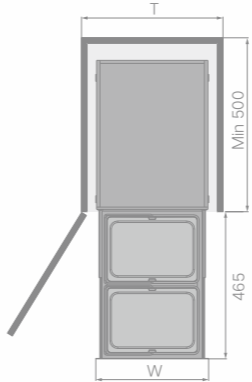

ART.NO	CABINET	W x D x H	MATERIAL	REMARK
307013	400mm	345x500x310mm	Plastic	2x15L



SOFT CLOSE WASTEBIN

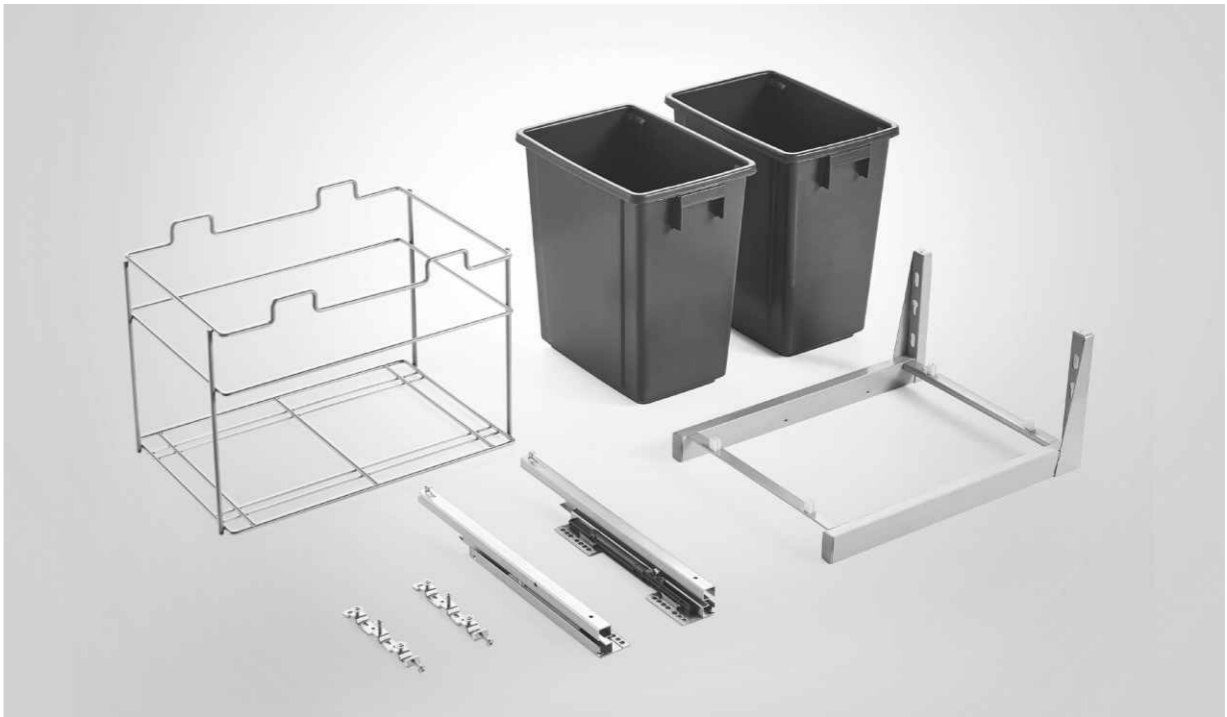
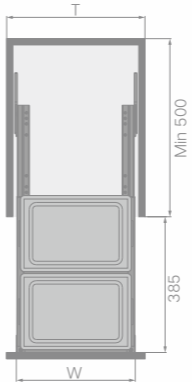

ART.NO	CABINET	W x D x H	MATERIAL	SURFACE	REMARK	COLOR
307012	450mm	345x475x440mm	Steel+Plastic	Nano-coating	2x17L	Metallic grey+Black



US STYLE WASTEBIN

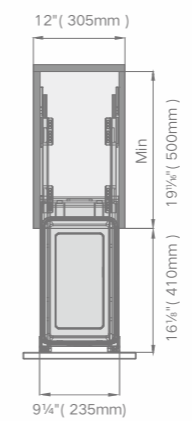

ART.NO	CABINET	W x D x H	MATERIAL	REMARK
307027	300mm	235x465x500mm	Steel+Plastic	1x28L



US STYLE WASTEBIN

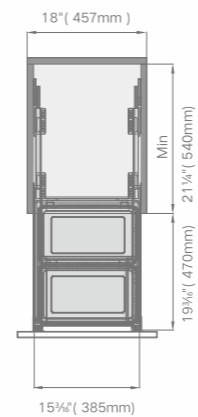

ART.NO	CABINET	W x D x H	MATERIAL	REMARK
307026	450mm	385x520x500mm	Steel+Plastic	2x28L

WARDROBE SYSTEMS

HIGOLD®

Leading Design
Perfect Experience



WARDROBE

Higold wardrobe storage function hardware system, multi-dimensional display practical storage ingenuity and space aesthetic design, the integration of pragmatism and Romanticism, for consumers to provide a full set of cloakroom storage solution, to create a life of grace and ease.





B SERIES



B 2.0 SERIES



A SERIES



MUSE SERIES

ELEGANT AND MODERN

Use artistic colors to
interpret the fashion style of urban upstarts,
continuing elegance and respect.

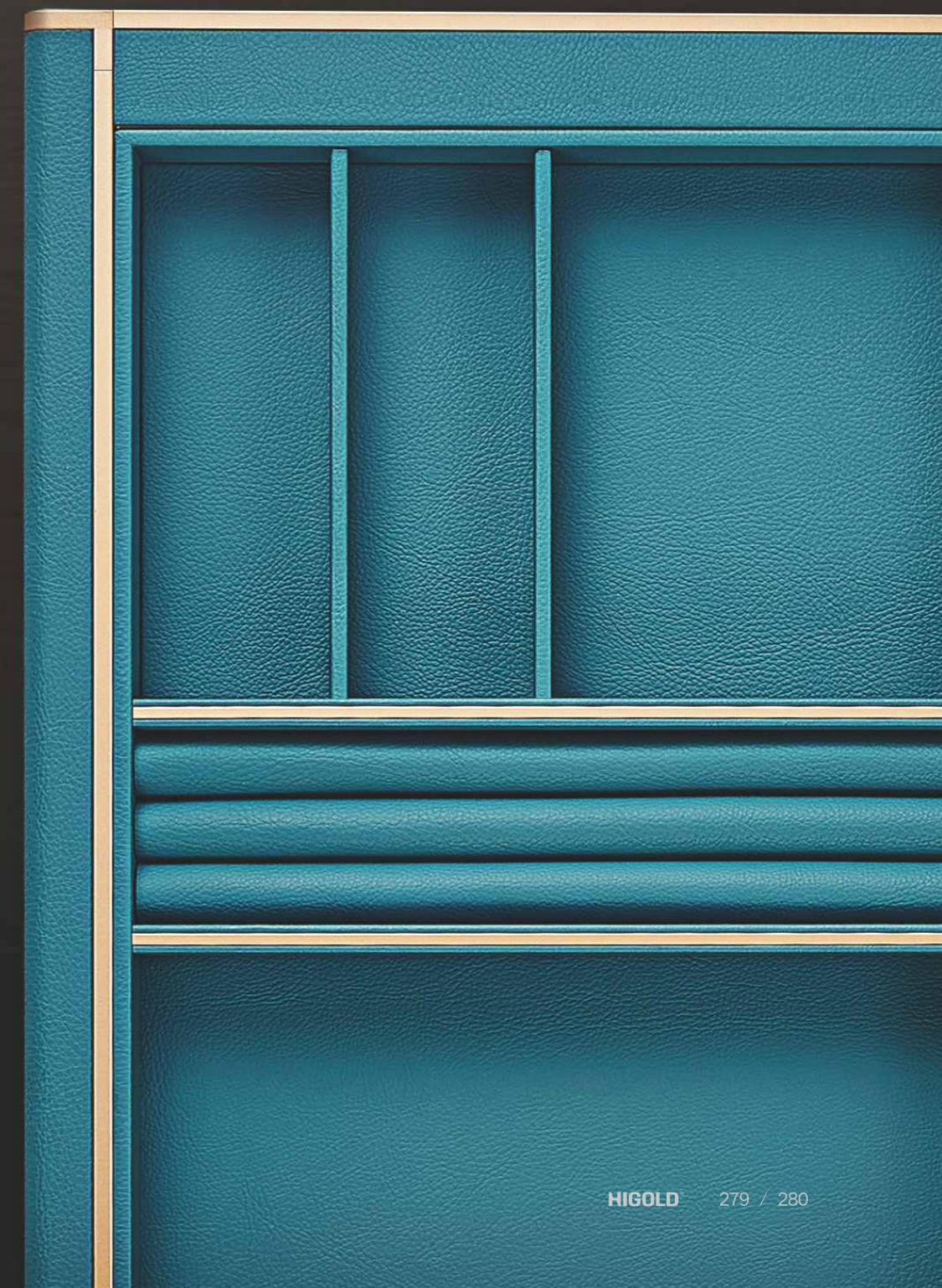
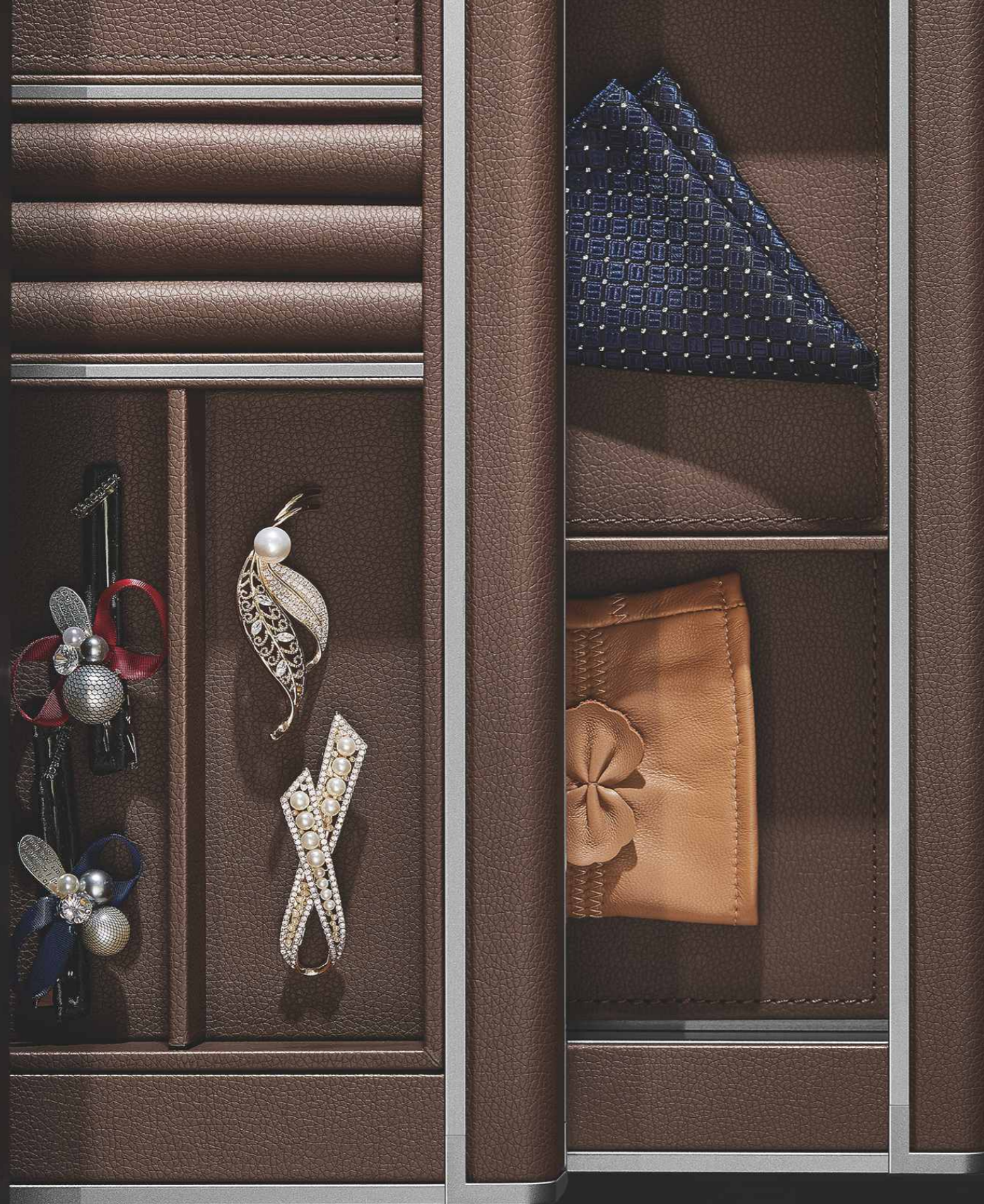

B SERIES

MORAN GREEN

Like a blonde in a green woolen coat, walking slowly from an oil painting.

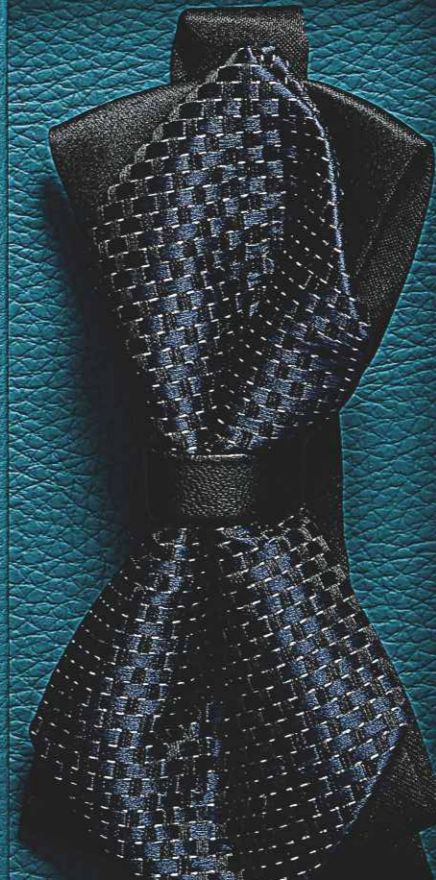

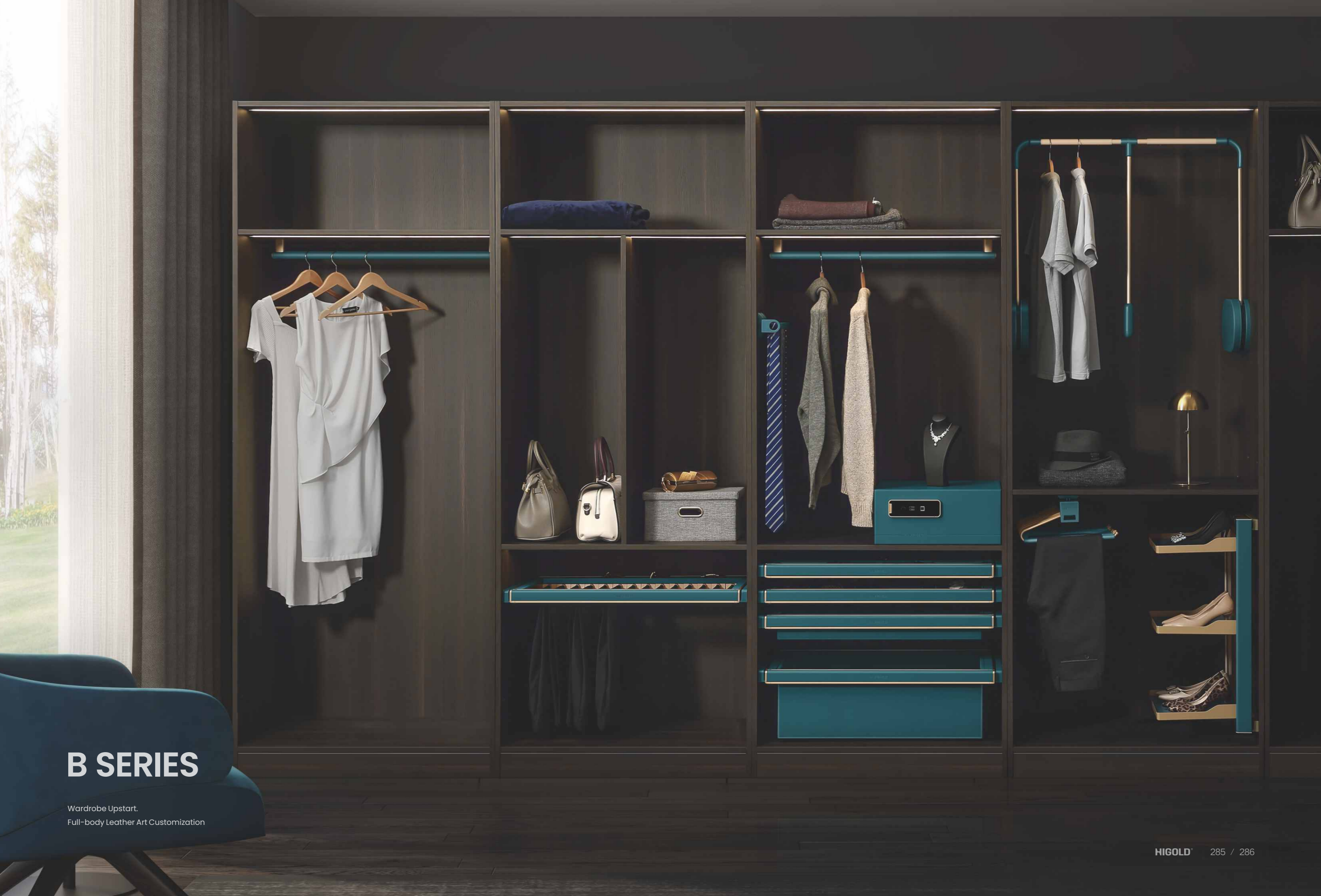

B SERIES

Wardrobe Upstart.
Full-body Leather Art Customization



B SERIES

MORAN GREEN ACCESSORIES STORAGE BOX

Earrings, jewelry, and hair accessories are stored in a basket. Every time, it's like opening a treasure box, slowly choosing the jewelry that fits the day's dress, and traveling shingly.



MORAN GREEN MULTI-FUNCTIONAL STORAGE BOX

Store small items in order to keep warm from the cold, and you can take them as you need them when the season changes.



MORAN GREEN UNDERWEAR STORAGE BOX

Private clothing should be treated with care. Be purely restrained and release elegance, in the most intimate family space.





MORAN GREEN
DEEP LEATHER BASKET

Thick coats and bedding in winter donot take up closet space.



MORAN GREEN
SHALLOW LEATHER BASKET

Summer thin silk scarves and smallvests are stored uniformly, so you arenot afraid of losing them when youbid farewell to the mess.



MORAN GREEN TIE RACK

Hanging storage avoids zoubaba travel;
avariety of styles are intuitive and easy to matchbefore going to work.

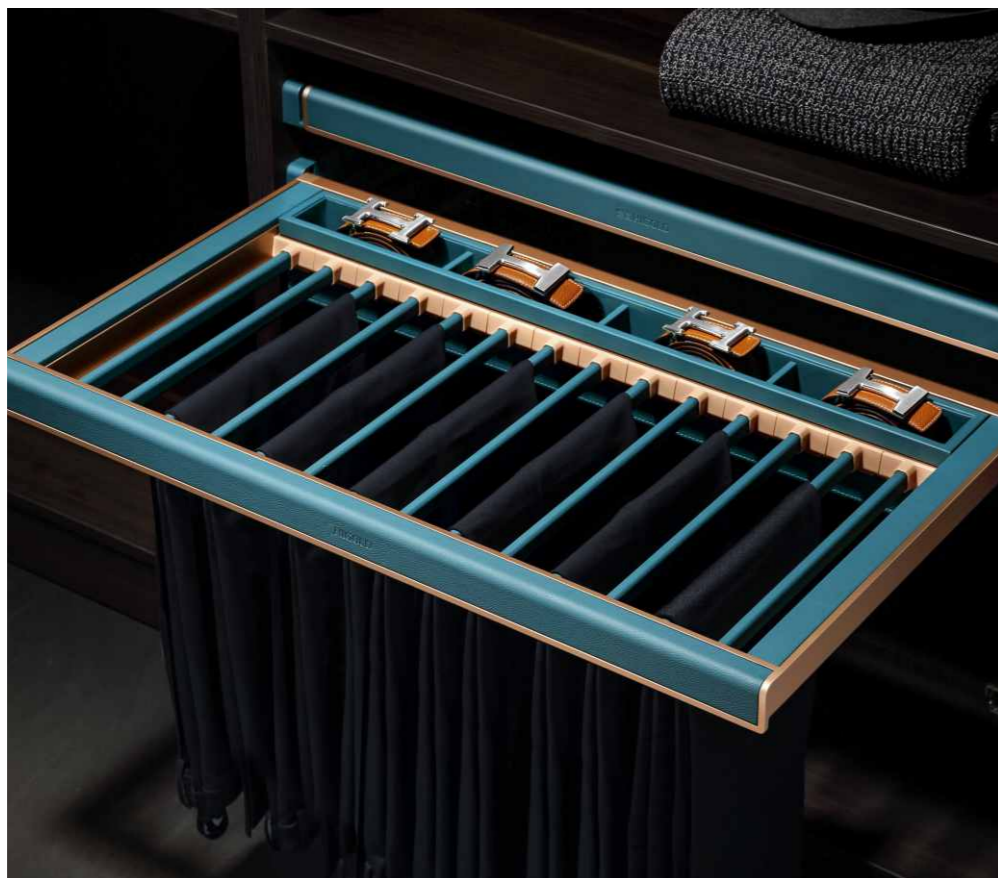

TROUSERS RACK

MORAN GREEN

The belt storage compartment is newly added which is neatly stored and can be taken as needed.

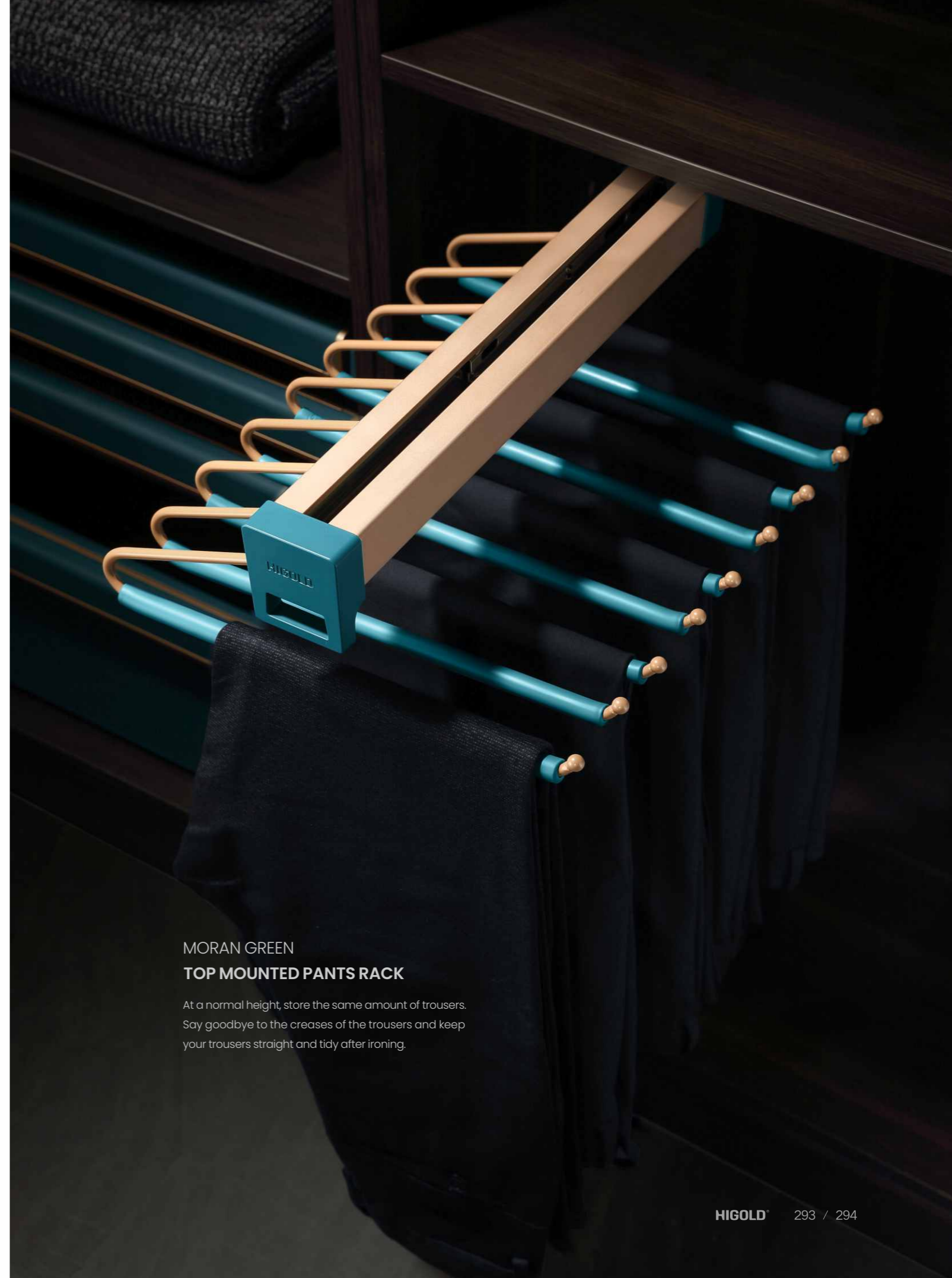

MORAN GREEN TOP MOUNTED PANTS RACK

At a normal height, store the same amount of trousers. Say goodbye to the creases of the trousers and keep your trousers straight and tidy after ironing.

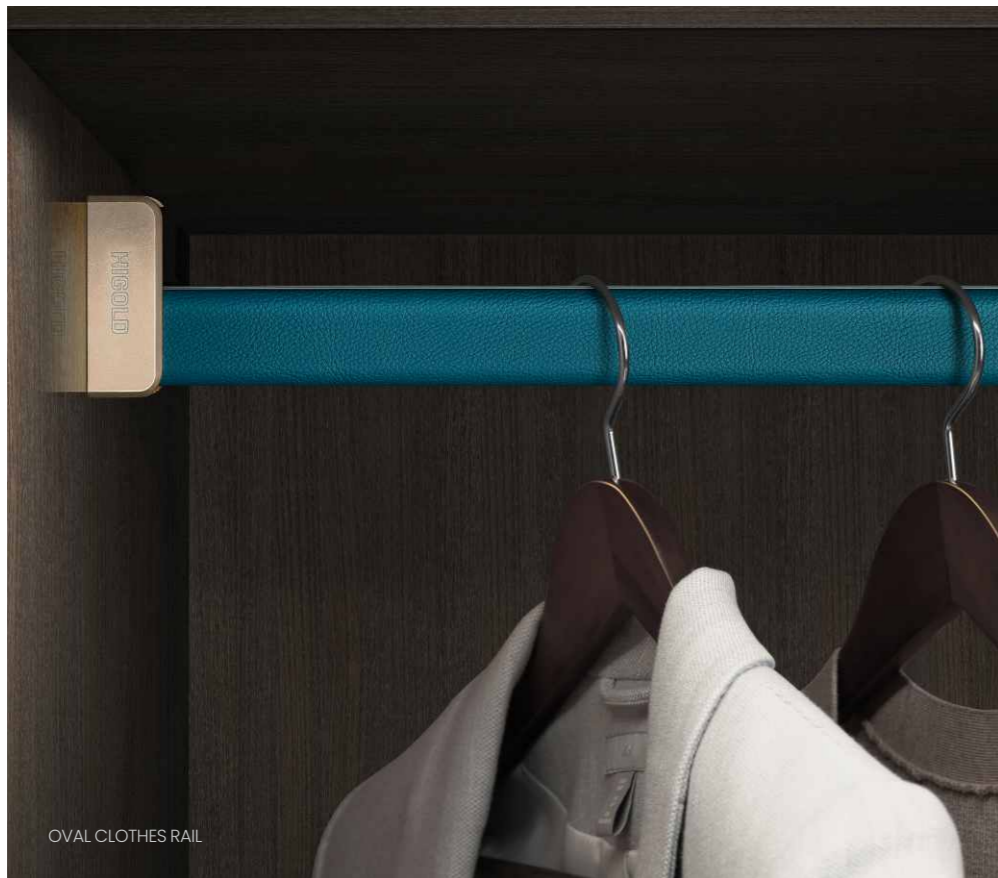

HANG GARMENT LEVER

MORAN GREEN

Match your favorite dresses with gorgeous garment lever.
Add elegance to your wardrobe.

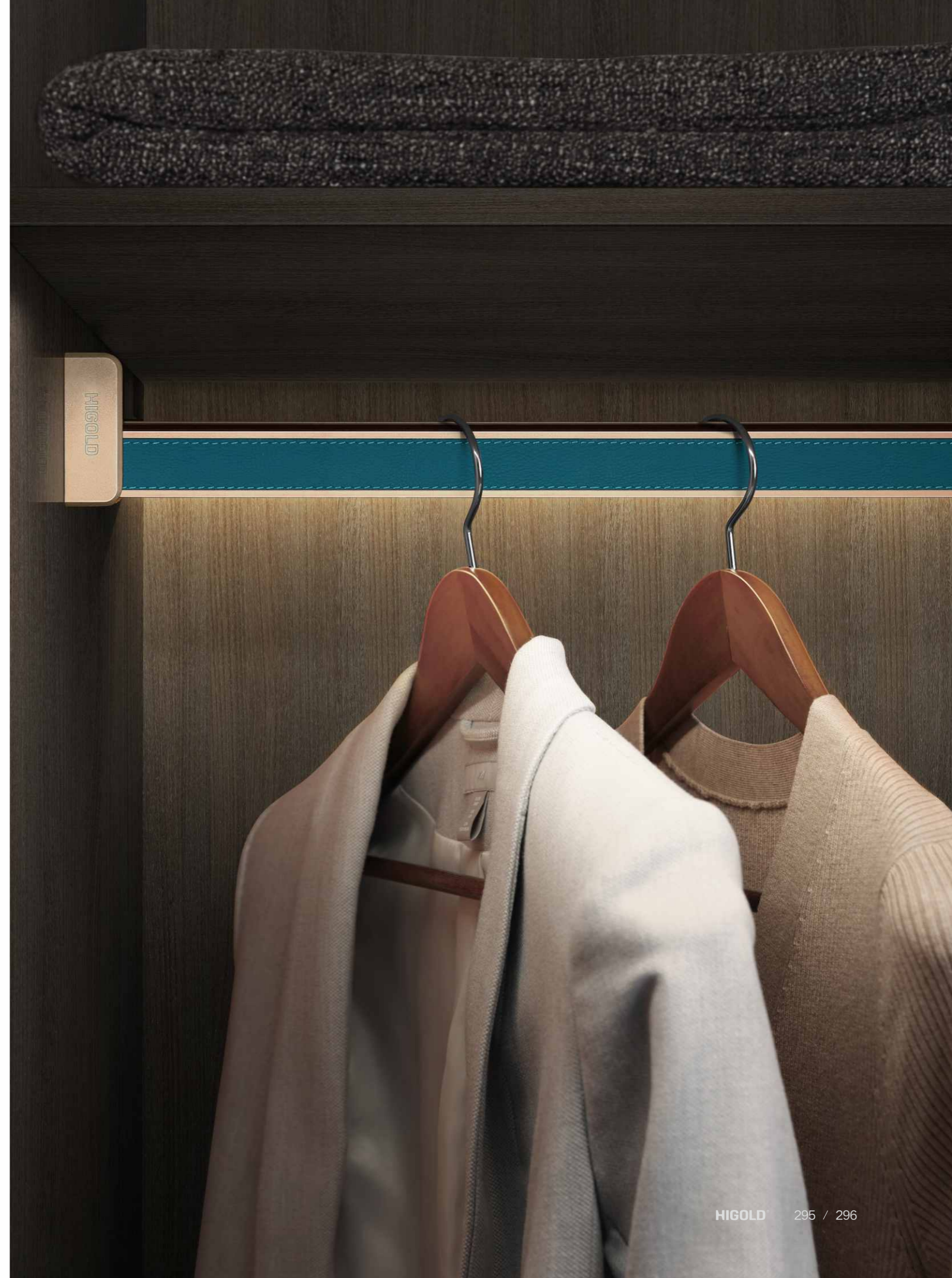



**MORAN GREEN
CLOTHING LIFTING RACK**

Particularly suitable for large wardrobes,
you can hold it no matter how high.



**MORAN GREEN
FULL-LENGTH MIRROR**

The height of 169cm clearly shows the overall
matching effect of each small accessory
on the body.





**MORAN GREEN
ROTATING SHOE RACK**

360° all-round turn-in design, Take put shoes and selection becomes easy, elegant and easy.



**MORAN GREEN
O-SHAPED CORNER CLOTHES RACK**

The difficult problem of traditional wardrobe corners is solved. The longitudinal space is cut into three layers of available positions for large capacity storage bags, clothes, leather cases, etc.

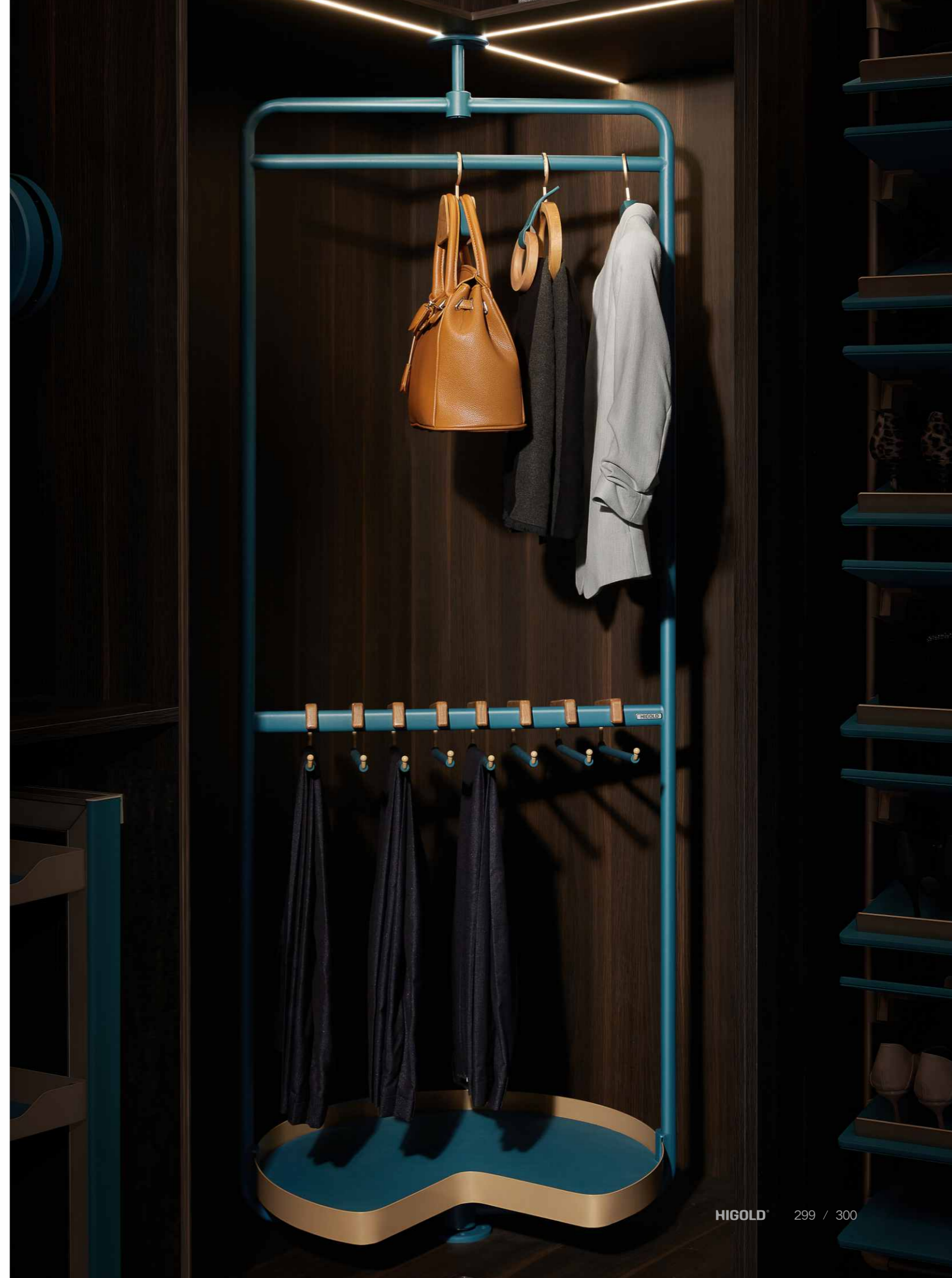

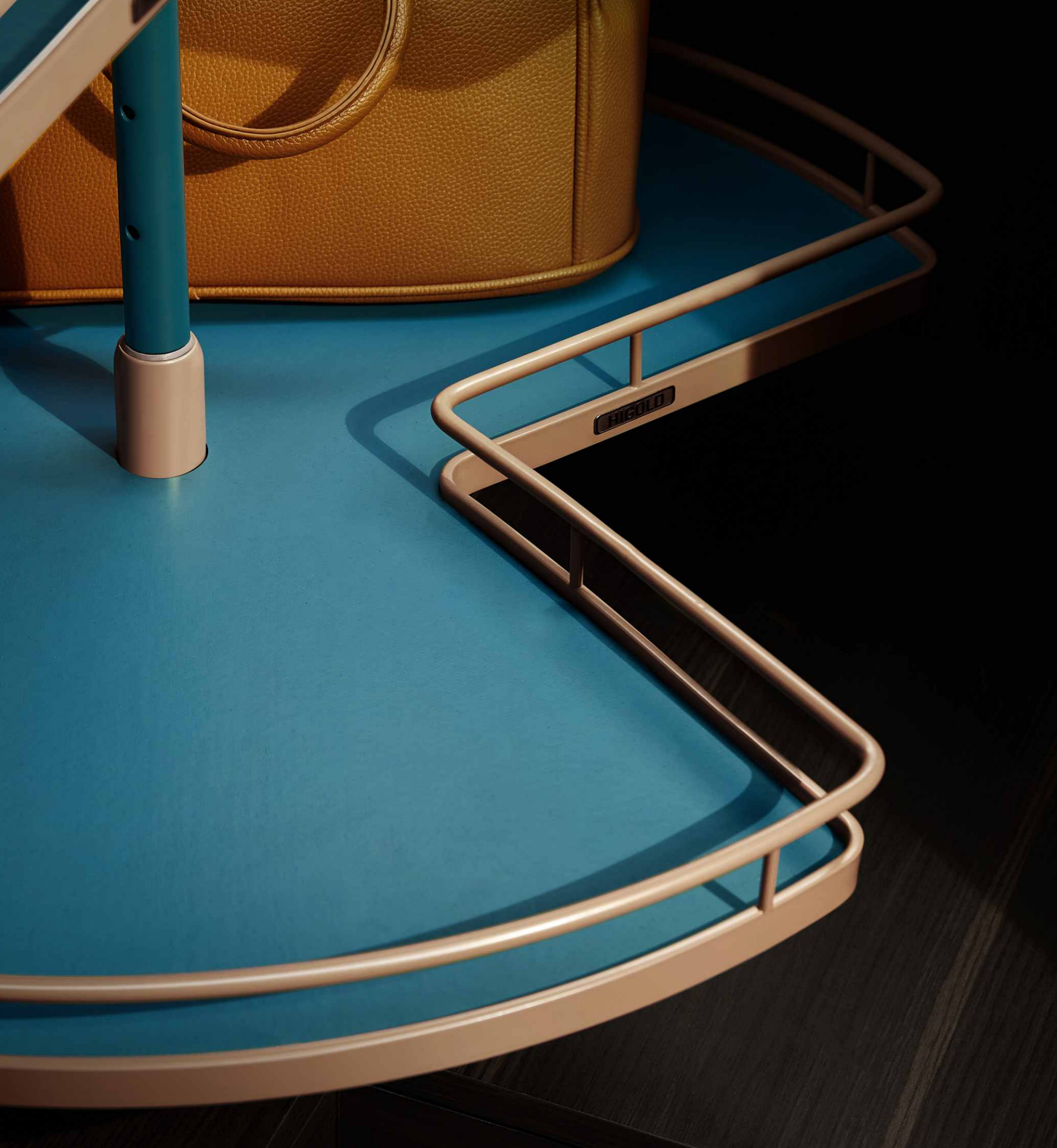

THREE LAYERS CAROUSEL

MORAN GREEN

Designed for corners, 360°rotating design,
objects can be easily retrieved no matter how deep they are hidden.

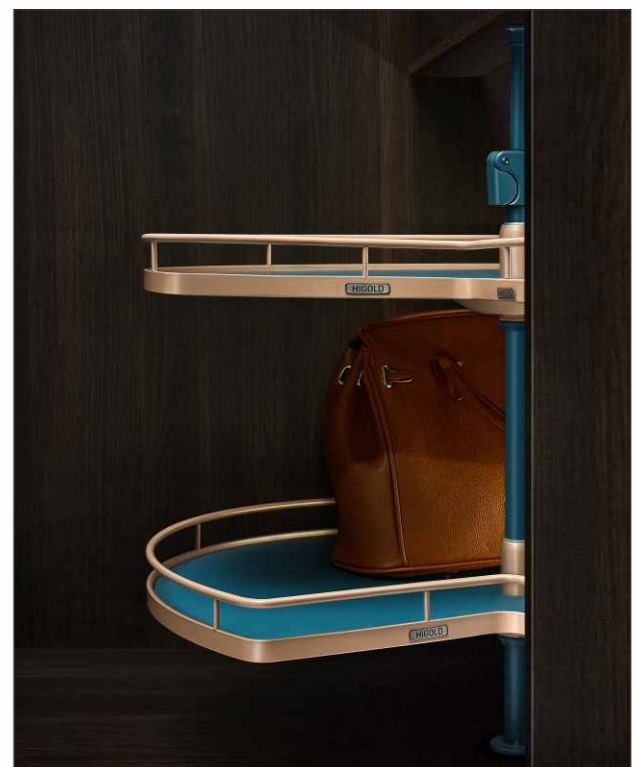



SIDE MOUNT

MORAN GREEN

Side-pull out, clear at a glance, easy to take. Precise guide rail design gives you weightless experience, elegance exists between pushing and pulling.

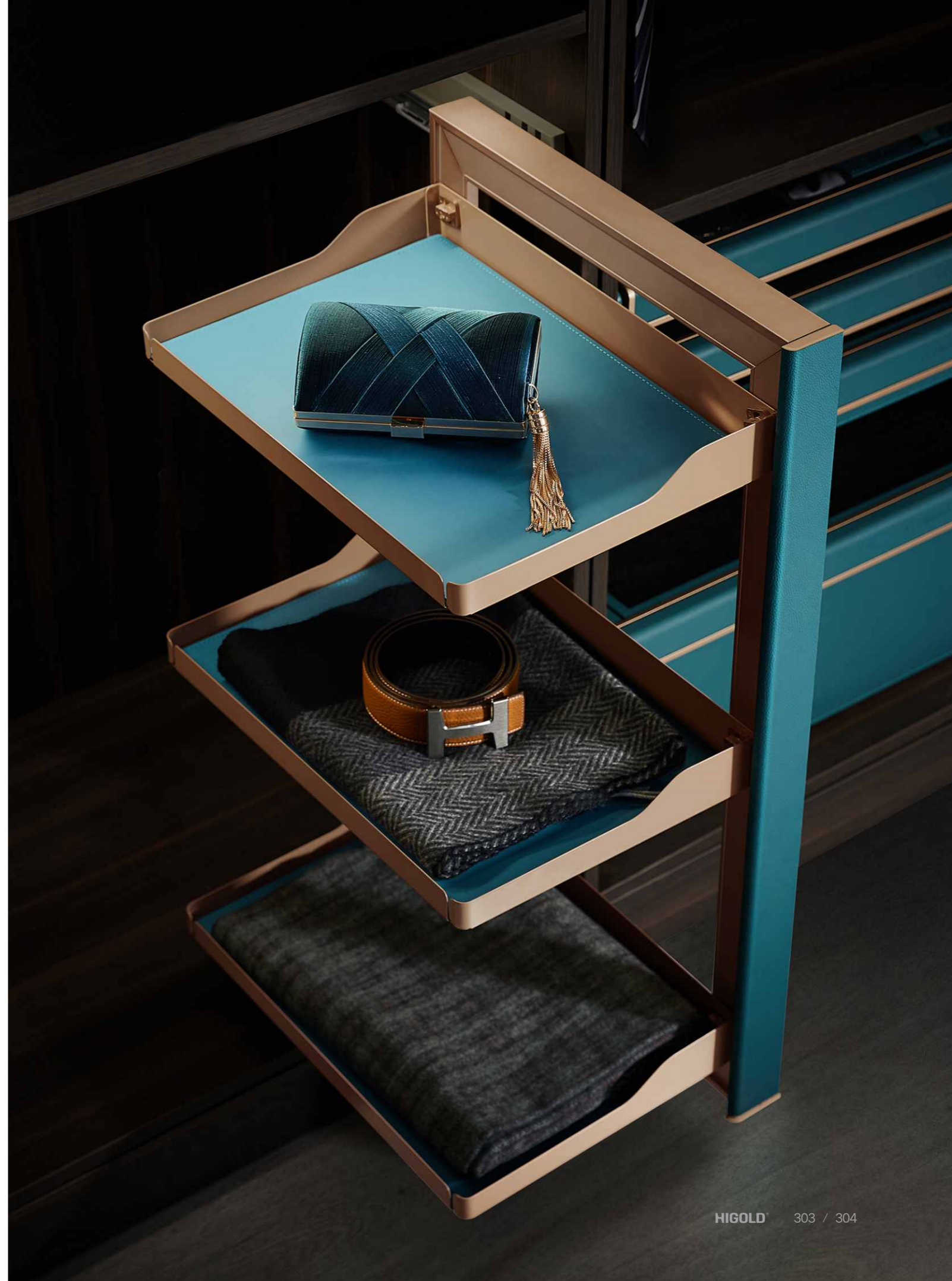



WOODEN CLOTHES HANGER

MORAN GREEN

All kinds of wooden clothes hangers can meet the needs of modern family wardrobes to store clothes, and the clothes accessories are neat and orderly, and it is more considered to solve the problem of picking and hanging clothes.

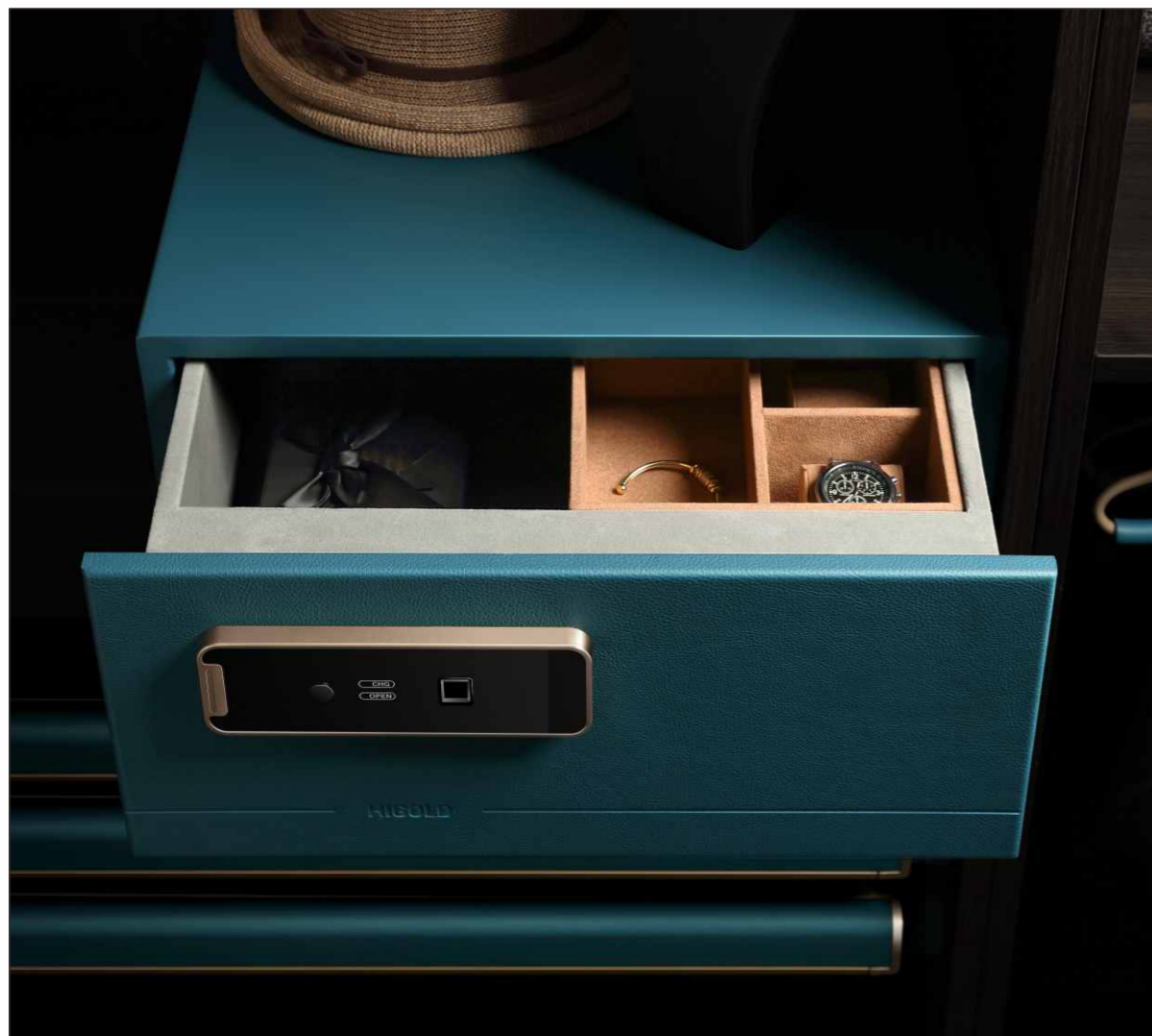

STEEL SAFE

MORAN GREEN

Fingerprint unlocking, no longer worry about losing precious watches and jewelry, and protect precious things privately.



WATCH WINDER

MORAN GREEN

The watch shaker is equipped with a micro motor, which drives the small dial to rotate slowly. The mechanical watch is placed in the dial to achieve the effect of automatic winding, which can prevent the mechanical watch from stopping when the mechanical watch is idle for a long time due to insufficient exercise.



ACCESSORIES STORAGE BOX

Patent NO. : ZL202030714465.X
 Patent NO. : ZL202030714559.7
 Patent NO. : ZL202120623138.2

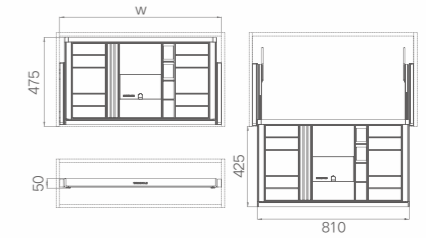
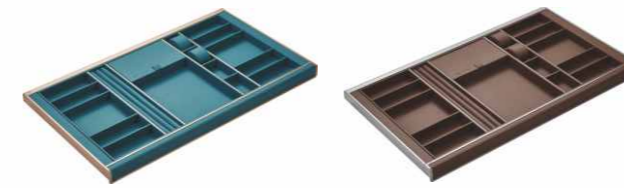

ART.NO (Moran Green)	ART.NO (Premium Gray)	CABINET	W x D x H	REMARK
706041M	706041S	600mm	564x475x50mm	soft close
706042M	706042S	700mm	664x475x50mm	
706043M	706043S	800mm	764x475x50mm	
706044M	706044S	900mm	864x475x50mm	

MULTI-FUNCTIONAL STORAGE BOX

Patent NO. : ZL202030714559.7
 Patent NO. : ZL202120623138.2

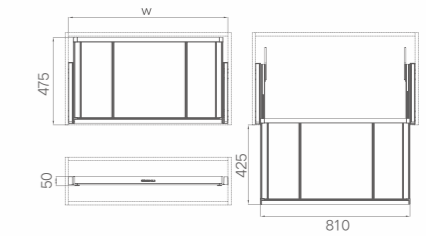
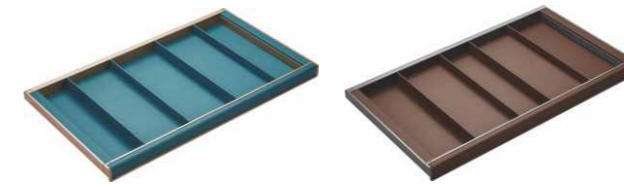

ART.NO (Moran Green)	ART.NO (Premium Gray)	CABINET	W x D x H	REMARK
706001M	706001S	600mm	564x475x50mm	soft close
706002M	706002S	700mm	664x475x50mm	
706003M	706003S	800mm	764x475x50mm	
706004M	706004S	900mm	864x475x50mm	

UNDERWEAR STORAGE BOX

Patent NO. : ZL202030714492.7
 Patent NO. : ZL202030714559.7
 Patent NO. : ZL202120623138.2

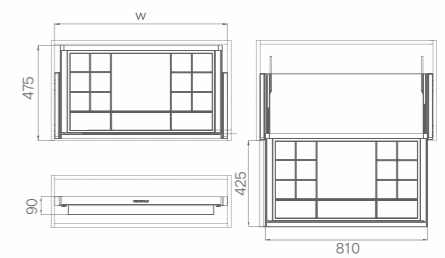
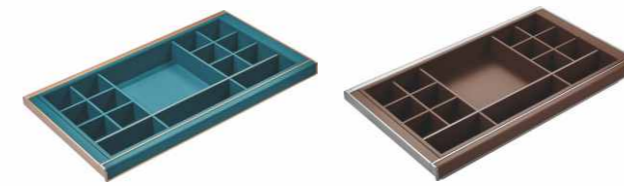

ART.NO (Moran Green)	ART.NO (Premium Gray)	CABINET	W x D x H	REMARK
706011M	706011S	600mm	564x475x90mm	soft close
706012M	706012S	700mm	664x475x90mm	
706013M	706013S	800mm	764x475x90mm	
706014M	706014S	900mm	864x475x90mm	

DEEP LEATHER BASKET

Patent NO.: ZL202030714559.7
Patent NO.: ZL202120623138.2



ART.NO (Moran Green)	ART.NO (Premium Gray)	CABINET	W x D x H	REMARK
706051M	706051S	600mm	564x475x250mm	soft close
706052M	706052S	700mm	664x475x250mm	
706053M	706053S	800mm	764x475x250mm	
706054M	706054S	900mm	864x475x250mm	

SHALLOW LEATHER BASKET

Patent NO.: ZL202030714559.7
Patent NO.: ZL202120623138.2



ART.NO (Moran Green)	ART.NO (Premium Gray)	CABINET	W x D x H	REMARK
706031M	706031S	600mm	564x475x150mm	soft close
706032M	706032S	700mm	664x475x150mm	
706033M	706033S	800mm	764x475x150mm	
706034M	706034S	900mm	864x475x150mm	

TROUSERS RACK

Patent NO.: ZL202030717074.3
Patent NO.: ZL202030714559.7
Patent NO.: ZL202120623138.2



ART.NO (Moran Green)	ART.NO (Premium Gray)	CABINET	W x D x H	REMARK
706021M	706021S	600mm	564x475x90mm	soft close
706022M	706022S	700mm	664x475x90mm	
706023M	706023S	800mm	764x475x90mm	
706024M	706024S	900mm	864x475x90mm	

TOP MOUNTED PANTS RACK

Patent NO.: ZL201930264233.6

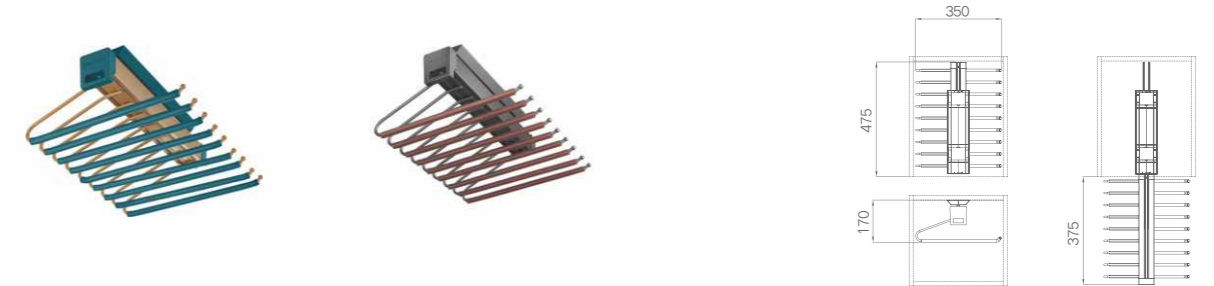

ART.NO (Moran Green)	ART.NO (Premium Gray)	CABINET	W x D x H	REMARK
703502M	703502S	≥400mm	350x475x170mm	soft close

ROTATING SHOE RACK

Patent NO. : ZL201930264676.5
 Patent NO. : ZL202122543108.3
 Patent NO. : ZL202220767539.X



ART.NO (Moran Green)	ART.NO (Premium Gray)	CABINET	W x D x H	REMARK
703591M	703591S	≥800mm	685x370x(1910-2110)mm	12 layers
703592M	703592S	≥800mm	685x370x(1630-1830)mm	10 layers
703593M	703593S	≥800mm	685x370x(1350-1550)mm	8 layers
703594M	703594S	≥800mm	685x370x(1070-1270)mm	6 layers
703595M	703595S	≥800mm	685x370x(790-990)mm	4 layers

O - SHAPED CORNER CLOTHES RACK

Patent NO. : ZL202130362804.7
 Patent NO. : ZL202122547976.9



ART.NO (Moran Green)	ART.NO (Premium Gray)	CABINET	W x D x H	REMARK
706202M	706202S	≥800mm	Φ 700x(1900-2100)mm	/

SIDE MOUNTED BASKET

Patent NO. : ZL201930264242.5



ART.NO (Moran Green)	ART.NO (Premium Gray)	CABINET	W x D x H	REMARK
703573M	703573S	≥400mm	360x475x795mm	left opening / soft close
703574M	703574S	≥400mm	360x475x795mm	right opening / soft close

FULL-LENGTH MIRROR

Patent NO. : ZL202030715715.1



ART.NO (Moran Green)	ART.NO (Premium Gray)	CABINET	W x D x H	REMARK
706161M	706161S	1700mm	400x55x1700mm	/

STEEL SAFE

Patent NO.: ZL202230193249.4

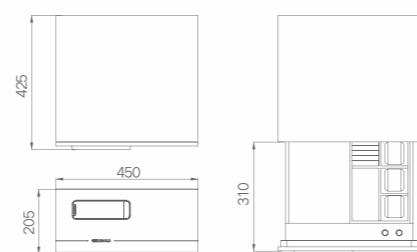

ART.NO (Moran Green)	ART.NO (Premium Gray)	CABINET	W x D x H	REMARK
703297M	703297S	≥490mm	450x425x205mm	/

WATCH WINDER

Patent NO.: ZL202230193029.1

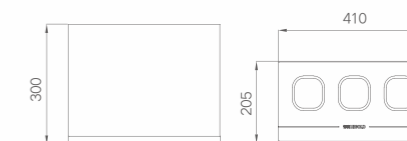

ART.NO (Moran Green)	ART.NO (Premium Gray)	W x D x H	REMARK
706154M	706154S	410x300x205mm	/

CLOTHING LIFTING RACK

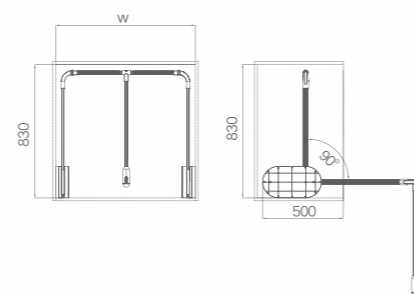

ART.NO (Moran Green)	ART.NO (Premium Gray)	CABINET	W x D x H	REMARK
703156M	703156S	900-1100mm	(864-1064)x500x830mm	soft close

WOODEN CLOTHES HANGER

ART.NO
(Moran Green)
706111M



ART.NO
(Premium Gray)
706111S

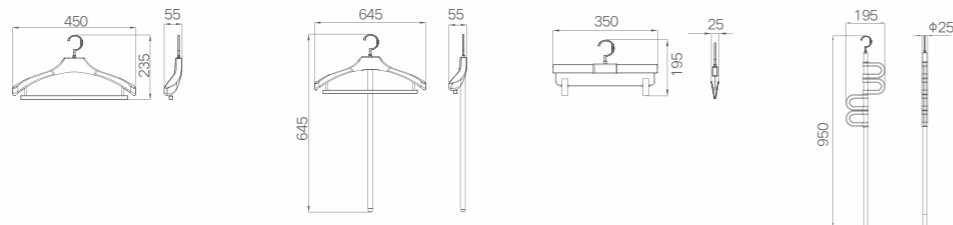

NAME	CLOTHES AND PANTS HANGER	SUIT HANGER	PANTS HANGERS	SCARF HANGER
------	--------------------------	-------------	---------------	--------------

W x D x H	450x55x235mm	400x55x645mm	350x25x195mm	195x25x950mm
-----------	--------------	--------------	--------------	--------------

WOODEN CLOTHES HANGER

ART.NO
(Moran Green)
706111M



ART.NO
(Premium Gray)
706111S

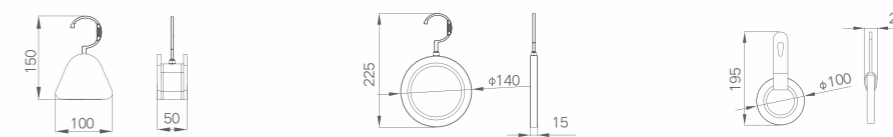

NAME	BAG HANGER	LARGE SCARF HANGING LOOP	SMALL SCARF HANGING LOOP
------	------------	--------------------------	--------------------------

W x D x H	100x50x150mm	140x15x225mm	100x25x195mm
-----------	--------------	--------------	--------------

OVAL CLOTHES RAIL

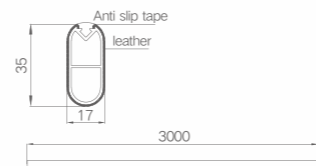
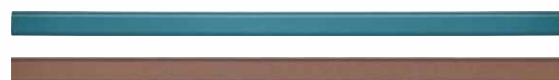

ART.NO (Moran Green)	ART.NO (Premium Gray)	CABINET	W x D x H	REMARK
706191M	706191S	3000mm	3000x17x35mm	Top mounting / Side mounting

HANGING ROD HOLDERS

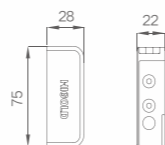

ART.NO (Moran Green)	ART.NO (Premium Gray)	W x D x H	REMARK
703660M	703660S	28x22x75mm	Top mounting / Side mounting Aluminum alloy

TIE RACK



ART.NO (Moran Green)	ART.NO (Premium Gray)	W x D x H	REMARK
703541M	703541S	85x435x95mm	/

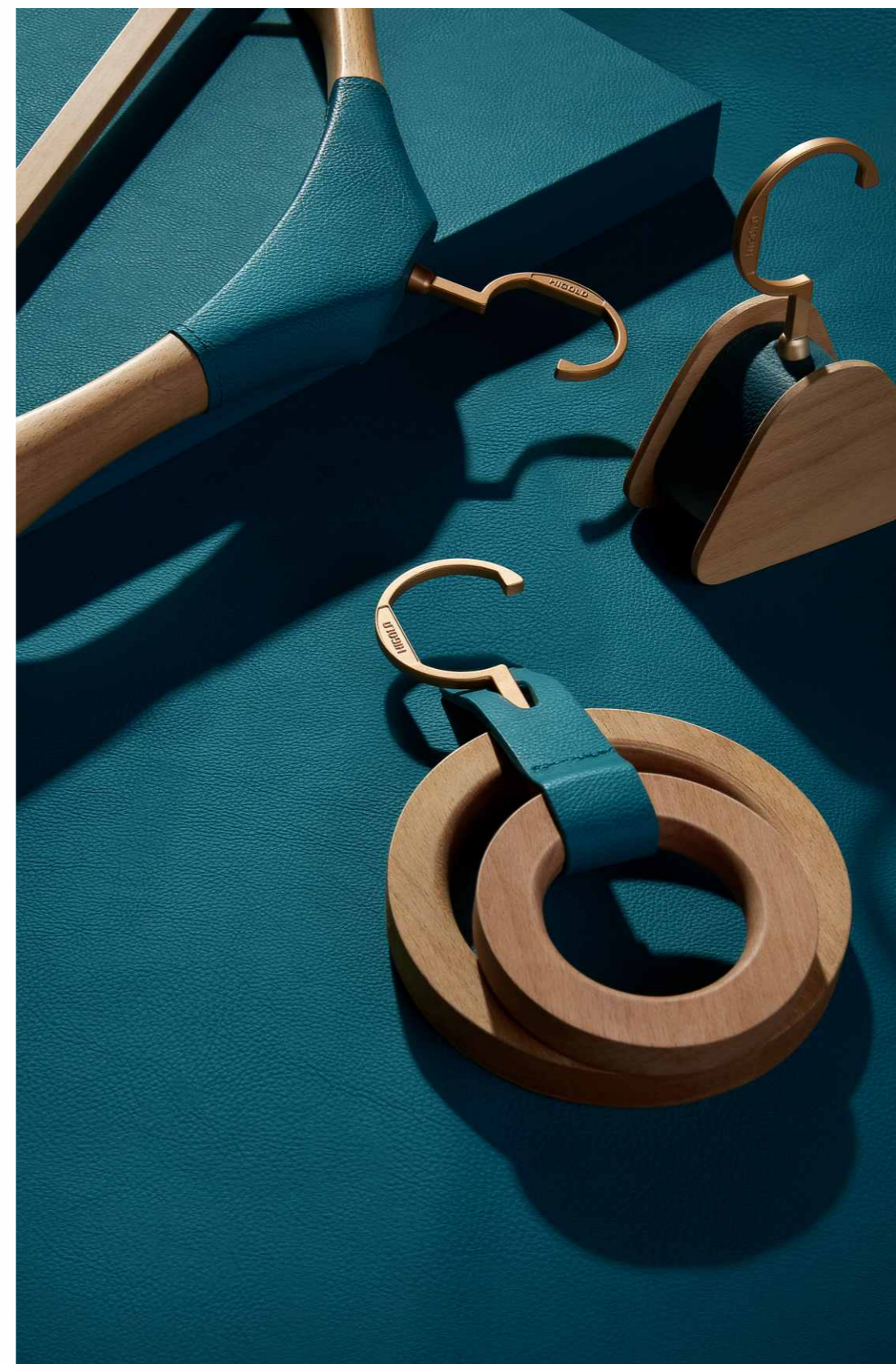

B 2.0 SERIES

Elegant and socialite style

Ultimate luxury feeling

Performing Elegant Art





B 2.0 SERIES

ELEGANCE



B2.0 SERIES

The BV 2.0 wardrobe storage system, since its creation, has given life the most sincere respect, appreciation, and care. With unique warmth and beauty, it perfectly blends luxurious leather and dazzling metal, bringing extraordinary innovation to private storage in a noble form.

Light and shadow flow, thousands of pink and Daisy flowers bloom freely; Perfectly beautiful, private storage pleasing to the eye. The beauty area, display area, stacking area, and pants hanging area are breathtaking, and the wardrobe space flows smoothly and gracefully; The ingenious storage foundation achieves a perfect balance between aesthetic structure and functionalism, making every smile and frown both calm and luxurious.





BEAUTY STORAGE BOX

Add beauty storage to meet more practicality

A perfect creation that leads the times, the "storage + beauty" functional partition is ingeniously designed.

Makeup and skin care tools are all in their own place, making it an epoch-making piece of beauty storage.





ACCESSORIES STORAGE BOX

Italian design, life aesthetics

Cleverly embellished with metallic lines and paired with delicate and rich textured leather, accessing accessories is well-organized and as bright as stars.





UNDERWEAR STORAGE BOX

Skin friendly leather for delicate storage of private items

Create carefully selected items with the heart of nature, respect the original needs, comprehensively protect delicate and thoughtful clothes, and protect a comfortable life.





MULTI-FUNCTIONAL STORAGE BOX

Thickened aluminum alloy, reinforced load

Collect art to make the space relaxed and generous, and treat yourself with luxury in every inch.

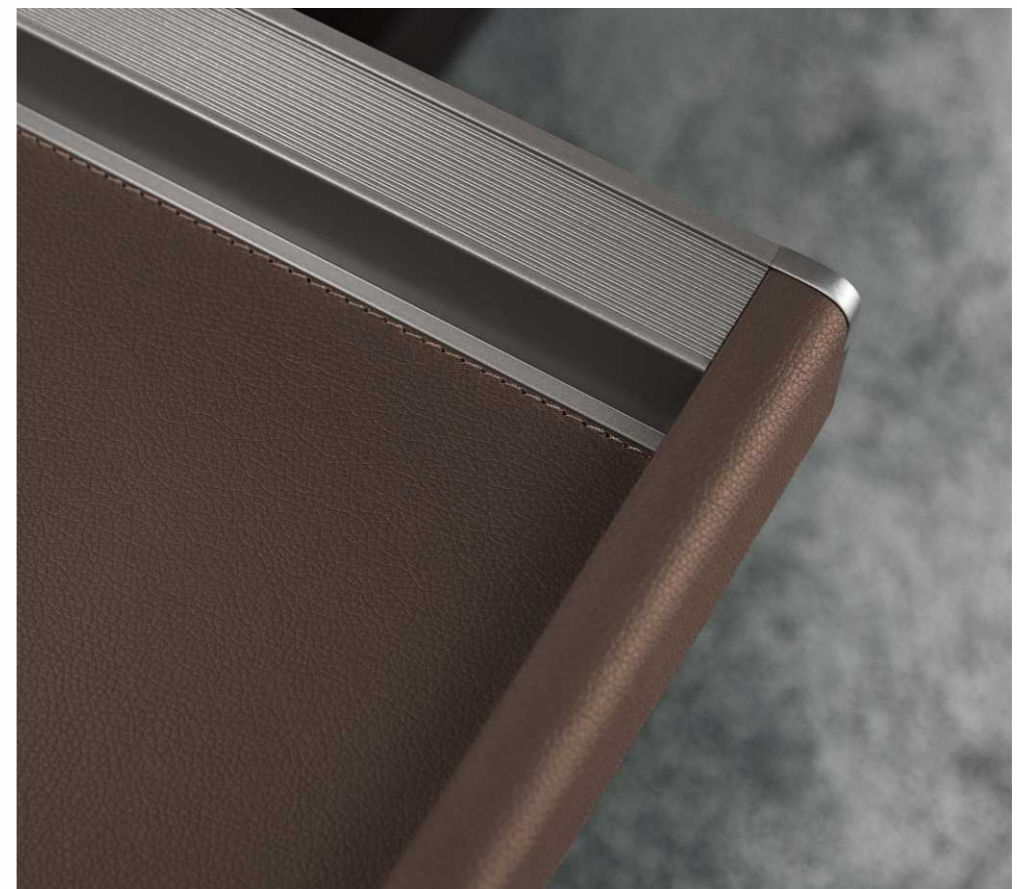



TROUSER SRACK

Soft-closing slide, with silent push and pull



Push and pull smoothly and quietly, non-slip and adjustable for easy access.
Luxurious trousers outfit award.



B2.0 SERIES
SHALLOW LEATHER BASKET

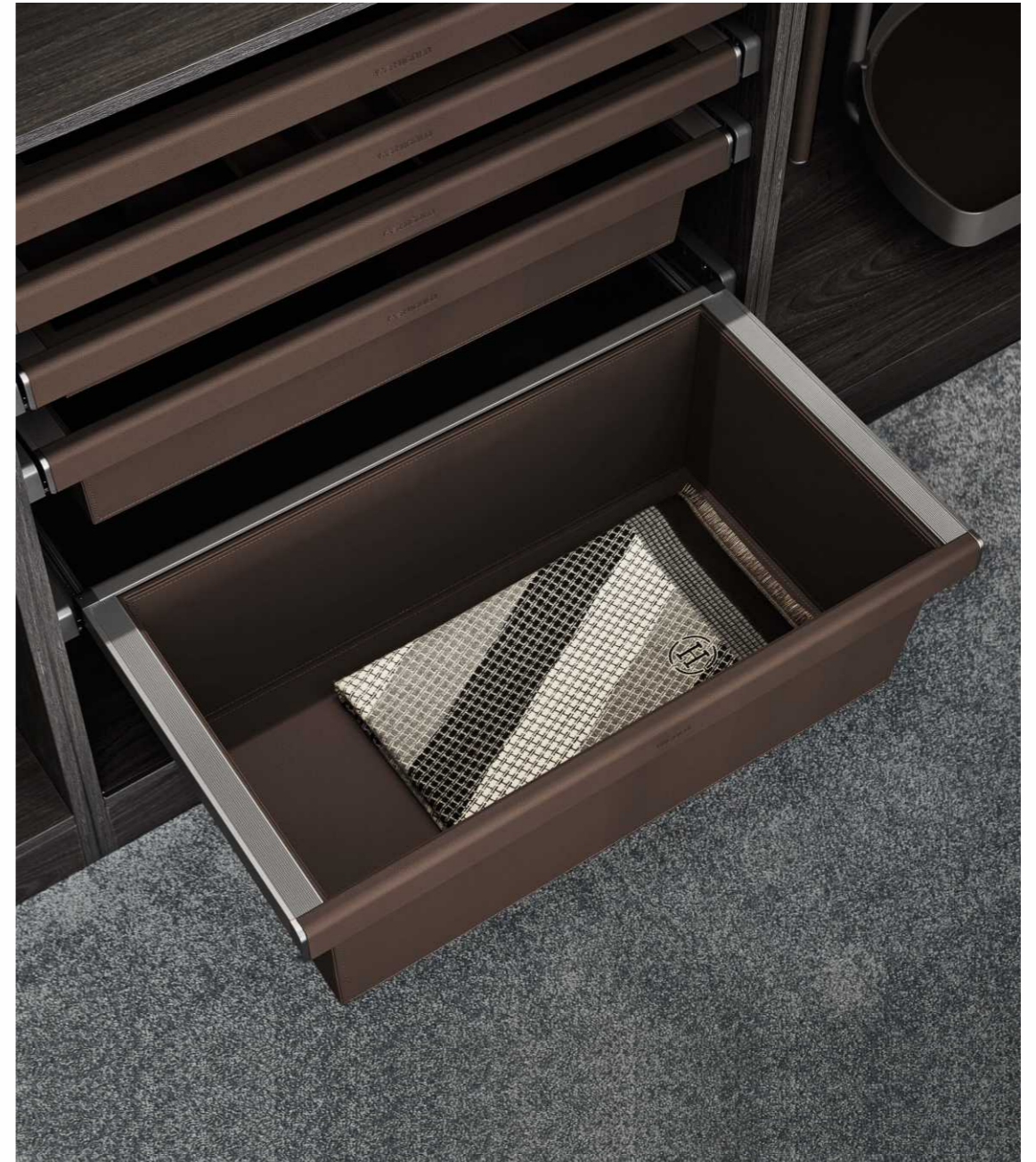

B2.0 SERIES
DEEP LEATHER BASKET

Thick clothes are carefully placed, deep leather basket can carry thousands of favors for your beloved



TOP MOUNTED DOUBLE ROW PANTS RACK

Double row layout, Double storage space

Dual-slides structure, Stable push-pull
Suspended top mounted, Easy installation

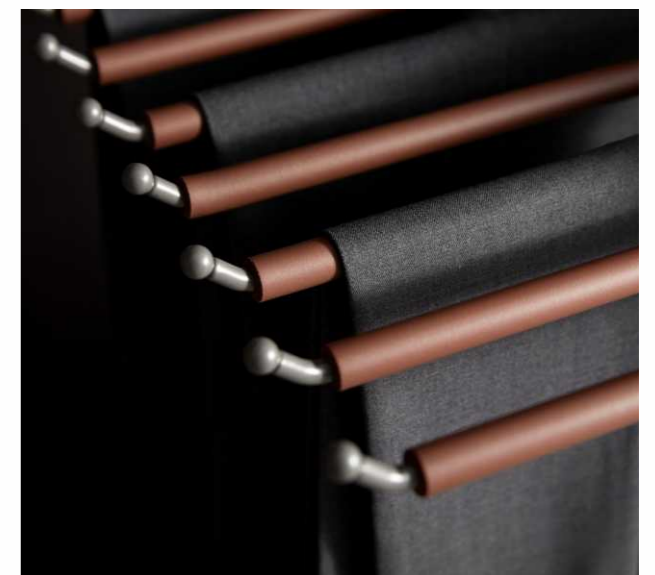



SHOE RACK WITH PU LEATHER

B2.0 series / Premium grey



BEAUTY STORAGE BOX



ART.NO (Premium Gray)	CABINET	W x D x H
706361S	600mm	564x475x50mm
706362S	700mm	664x475x50mm
706363S	800mm	764x475x50mm
706364S	900mm	864x475x50mm

ACCESSORIES STORAGE BOX



ART.NO (Premium Gray)	CABINET	W x D x H
706341S	600mm	564x475x50mm
706342S	700mm	664x475x50mm
706343S	800mm	764x475x50mm
706344S	900mm	864x475x50mm

UNDERWEAR STORAGE BOX



ART.NO (Premium Gray)	CABINET	W x D x H
706311S	600mm	564x475x90mm
706312S	700mm	664x475x90mm
706313S	800mm	764x475x90mm
706314S	900mm	864x475x90mm

MULTI-FUNCTIONAL STORAGE BOX



ART.NO (Premium Gray)	CABINET	W x D x H
706301S	600mm	564x475x50mm
706302S	700mm	664x475x50mm
706303S	800mm	764x475x50mm
706304S	900mm	864x475x50mm

SHALLOW LEATHER BASKET



ART.NO (Premium Gray)	CABINET	W x D x H
706331S	600mm	564x475x160mm
706332S	700mm	664x475x160mm
706333S	800mm	764x475x160mm
706334S	900mm	864x475x160mm

DEEP LEATHER BASKET



ART.NO (Premium Gray)	CABINET	W x D x H
706351S	600mm	564x475x260mm
706352S	700mm	664x475x260mm
706353S	800mm	764x475x260mm
706354S	900mm	864x475x260mm

TROUSERS RACK



ART. NO (Premium Gray)	CABINET	W x D x H
706321S	600mm	564x475x50mm
706322S	700mm	664x475x50mm
706323S	800mm	764x475x50mm
706324S	900mm	864x475x50mm

SHOE RACK WITH PU LEATHER



ART. NO (Premium Gray)	CABINET	W x D x H
706571	600mm	564x470x195mm
706572	700mm	664x470x195mm
706573	800mm	764x470x195mm
706574	900mm	864x470x195mm

TOP MOUNTED DOUBLE ROW PANTS RACK



ART. NO (Premium Gray)	CABINET	W x D x H
706126	800mm	683x450x100mm



A SERIES ADVANCED UNITS

Use artistic colors to interpret the fashion style of urban upstarts,
continuing elegance and respect.





DEEP LEATHER BASKET - A SERIES



UNDERWEAR STORAGE BOX - A SERIES



ACCESSORIES STORAGE BOX - A SERIES



PANT RACK
PREMIUM GRAY

Adopt grab type to hang, enlarge not only receive a space, and take convenient.
Thick hanging strip design, pants not easy to slip, not easy to crease,
Say goodbye to clutter and keep your pants straight and neat after ironing.





**PREMIUM GRAY
CORNER CLOTHES BASKET**

Cut the difficult-to-use high and deep space at the corner into three usable positions, transforming it into a large-capacity space for storing bags, clothing, and suitcases.



**PREMIUM GRAY
ROTATING SHOE RACK**

Designed for corners, 360° rotating design, objects can be easily retrieved no matter how deep they are hidden.





SAFE BOX
PREMIUM GRAY

Three silent slides, draw quiet.
Invisible storage, anti-dirty collision.

ROTATING FRAME
PREMIUM GRAY

Particularly suitable for large wardrobes,
you can hold it no matter how high.





SHOE RACK

A series / Premium grey



ACCESSORIES STORAGE BOX

Patent NO.: ZL201921241422.2

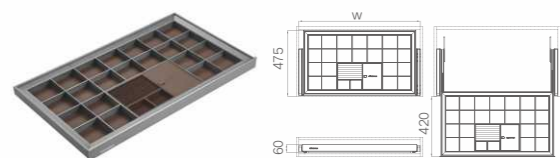

ART.NO (Premium Gray)	CABINET	W x D x H
703741S	600mm	564x475x60mm
703742S	700mm	664x475x60mm
703743S	800mm	764x475x60mm
703744S	900mm	864x475x60mm

TROUSERS RACK

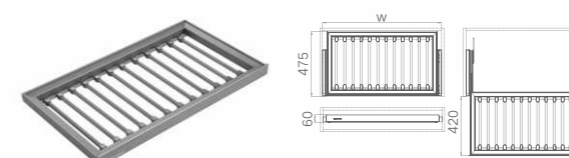

ART.NO (Premium Gray)	CABINET	W x D x H
703721S	600mm	564x475x60mm
703722S	700mm	664x475x60mm
703723S	800mm	764x475x60mm
703724S	900mm	864x475x60mm

UNDERWEAR STORAGE BOX

Patent NO.: ZL201921241422.2

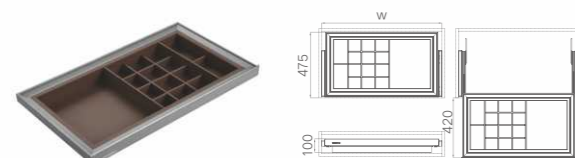

ART.NO (Premium Gray)	CABINET	W x D x H
703711S	600mm	564x475x100mm
703712S	700mm	664x475x100mm
703713S	800mm	764x475x100mm
703714S	900mm	864x475x100mm

SHOE RACK



ART.NO (Premium Gray)	CABINET	W x D x H
703771	600mm	564x465x205mm
703772	700mm	664x465x205mm
703773	800mm	764x465x205mm
703774	900mm	864x465x205mm

DEEP LEATHER BASKET

Patent NO.: ZL201921241422.2

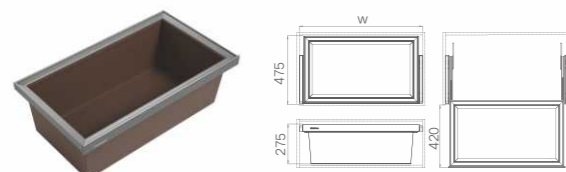

ART.NO (Premium Gray)	CABINET	W x D x H
703731S	600mm	564x475x275mm
703732S	700mm	664x475x275mm
703733S	800mm	764x475x275mm
703734S	900mm	864x475x275mm

CORNER CLOTHES BASKET

Patent NO.: ZL201921241422.2



ART.NO (Premium Gray)	CABINET	W x D x H
703552S	≥800mm	φ725x(1900-2100)mm

SAFE BOX

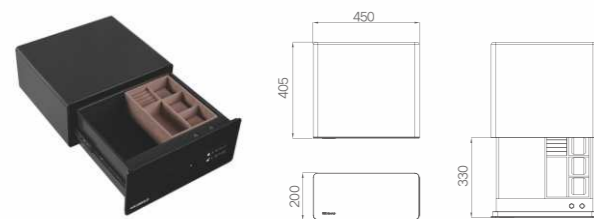

SENSER TOUCH (COUNTERTOP)

ART.NO (Premium Gray)	W x D x H
703296S	450x405x200mm

SAFE BOX



FINGERPRINT+TOUCH SCREEN+KEY (BUILT-IN)

ART.NO (Premium Gray)	W x D x H
703290	480x400x150mm

FULL-LENGTH MIRROR

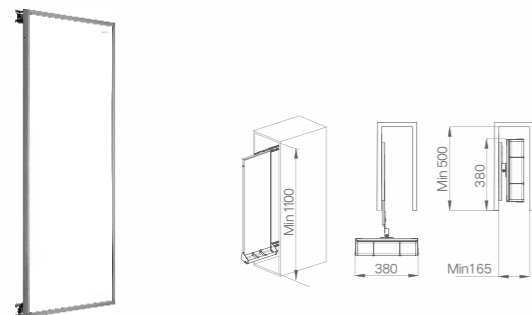

ART.NO (Premium Gray)	CABINET	W x D x H
703565S	≥200mm	380x140x1000mm

HANG GARMENT LEVER



ART.NO (Premium Gray)	CABINET	W x D x H
703580S	Socket	25x19x75mm
703581S	Clothes Rail	3000x15x38mm

ROTATING SHOE RACK

Patent NO. : ZL201930264676.5
Patent NO. : ZL202122543108.3
Patent NO. : ZL202220767539.X

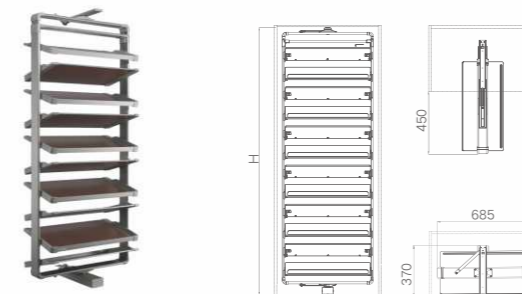

ART.NO (Premium Gray)	CABINET	W x D x H
703691S	≥800mm (12 layers)	685x370x(1910-2110)mm
703692S	≥800mm (10 layers)	685x370x(1630-1830)mm
703693S	≥800mm (8 layers)	685x370x(1350-1550)mm
703694S	≥800mm (6 layers)	685x370x(1070-1270)mm
703695S	≥800mm (4 layers)	685x370x(790-990)mm

O SHAPE ROTATING SHOE RACK

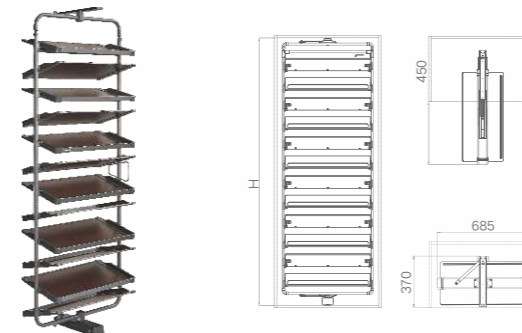

ART.NO (Premium Gray)	CABINET	W x D x H
703791	≥800mm (12 layers)	700x370x(1940-2040)mm
703792	≥800mm (10 layers)	700x370x(1660-1760)mm
703793	≥800mm (8 layers)	700x370x(1380-1480)mm
703794	≥800mm (6 layers)	700x370x(1100-1200)mm
703795	≥800mm (4 layers)	700x370x(820-920)mm

MUSE SERIES

Returning to the simplicity of beauty
It's a new era
The luxury that should be





HIGOLD

MUSE SERIES

MINIMALIST STYLE



MUSE SERIES

The Muse series pursues the "organic" combination of fashion and environmental protection. Under the ingenious conception of the designer, a natural life is achieved. The beauty of extreme simplicity.

The Muse series takes the shape of "felt" and replaces the cold and hard metal texture with softness. It abandons complicated shapes and uses simple frames to create a more agile visual effect and a wider storage space, and reap the relaxation of returning to nature feel.





MUSE SERIES

ACCESSORIES STORAGE BOX

Treasure chest style storage

Let every favorite thing have its own place and leave space for the life you love. The selected thick felt is soft to the touch and gentle on the accessories.



MULTI-FUNCTIONAL STORAGE BOX

Large flat design, leaving no dead space

Large flat design, leaving no dead space, free planning, use. Life is full of love and the storage potential is explored through design.



UNDERWEAR STORAGE BOX

Care for close-fitting and delicate clothing

Clear partitions provide flexible storage, providing a lot of convenience for storing close-fitting clothing.





CLOTHES BASKET

Upgrade capacity, well organized

The capacity of the clothes basket has been upgraded, so large items such as seasonal clothes and thin blankets can be "returned" in an orderly manner, containing all the love of life.





TROUSERS RACK

Pants leave no creases

The width of the trouser rack is adjustable, allowing the trousers to remain crease-free and create an organized style.



ACCESSORIES STORAGE BOX



ART.NO (Premium Gray)	CABINET	W x D x H
706641	600mm	564x480x75mm
706642	700mm	664x480x75mm
706643	800mm	764x480x75mm
706644	900mm	864x480x75mm

CLOTHES BASKET



ART.NO (Premium Gray)	CABINET	W x D x H
706631	600mm	564x480x180mm
706632	700mm	664x480x180mm
706633	800mm	764x480x180mm
706634	900mm	864x480x180mm

MULTI-FUNCTIONAL STORAGE BOX



ART.NO (Premium Gray)	CABINET	W x D x H
706601	600mm	564x480x75mm
706602	700mm	664x4810x75mm
706603	800mm	764x480x75mm
706604	900mm	864x480x75mm

TROUSERS RACK



ART.NO (Premium Gray)	CABINET	W x D x H
706621	600mm	564x480x75mm
706622	700mm	664x480x75mm
706623	800mm	764x480x75mm
706624	900mm	864x480x75mm

UNDERWEAR STORAGE BOX



ART.NO (Premium Gray)	CABINET	W x D x H
706611	600mm	564x480x100mm
706612	700mm	664x480x100mm
706613	800mm	764x480x100mm
706614	900mm	864x480x100mm

