

**Product Description**

- ◆ RS 485 MODBUS Control
- ◆ MODBUS RTU Communication
- ◆ Multi-control Functions Available
- ◆ SCR Antiparallel Output
- ◆ Monitoring Load Current, Voltage and Base Plate Temperature
- ◆ SCR Short Circuit, Open Circuit, Load Failure Detection Function
- ◆ Load Current: 40A
- ◆ LED Indicator
- ◆ RoHS Compliant

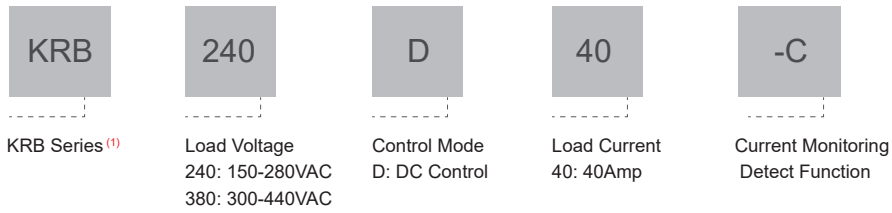

**Ordering Information**



Note (1): The part number selection is subject to the following list.

Information	240VAC	380VAC
model	KRB240D40-C	KRB380D40-C

**Control Modes**

Series	Mode Description	Input Control	Output Type
0	"On/Off mode"	RS 485	$U_{load} (ON)=U_{LN}$ , $U_{load} (OFF)=0VAC$
1	Power Proportion Output Mode		$U_{load}^2=U_{LN}^2 \times (REG\_CON/256)$
2	Cycle Control Output Mode 1		Num_Cycletotal=256, Num_Cycleon=REG_CON
3	Cycle Control Output Mode 2		Num_Cycletotal=REG_NUM, Num_Cycleon=REG_CON
4	Voltage Proportion Output Mode		$U_{load}=U_{LN} \times (REG\_CON/256)$
5	220VAC Stablized Voltage Output Mode		$U_{load}=220 \times (REG\_CON/256)^{(1)}$
6	220VAC Stablized Power Output Mode		$U_{load}^2=220^2 \times (REG\_CON/256)^{(1)}$
7	380VAC Stablized Voltage Output Mode		$U_{load}=380 \times (REG\_CON/256)^{(1)}$
8	380VAC Stablized Power Output Mode		$U_{load}^2=380^2 \times (REG\_CON/256)^{(1)}$

Note: (1)Power Supply Voltage  $U_{LN}$  should be higher than the setting value of output voltage  $U_{load}$ , Otherwise the output voltage is equivalent to power voltage.

**General Specifications**

Input Specifications	
Bias Power Supply Range	15 ~ 30VDC/AC
Max. Bias Power Supply Current	60mA
Input Control	RS 485

Output Specifications		
Power Supply Voltage Range	240VAC	150-280VAC
	380VAC	300-440VAC
Maximum Surge Current (@10ms)	600A	
Maximum I <sup>2</sup> t for Fusing (@10ms)	1800A <sup>2</sup> s	
Maximum Transient Overvoltage	1200Vpk	
Maximum Off-State Leakage Current@Rated Load Voltage	5mA	
Maximum On-State Voltage Drop@Rated Current	1.6Vrms	
Minimum Off-State dv/dt@Maximum Rated Voltage	500V/μS	

General Specifications		
Slave Address Range	001 ~ 255	
Maximum Nodes	255	
Signaling Rates	9.6kbps, 19.2kbps, 38.4kbps, 57.6kbps, 115.2kbps	
Communication Agreement	Modbus RTU	
Dielectric Strength (50/60Hz)	Input/Output	4000Vrms
	Input, output/Base	2500Vrms
Minimum Insulation Resistance (@500VDC)	1000MΩ	
Ambient Temperature Range	-30°C ~ +70°C	
Storage Temperature Range	-30°C ~ +100°C	
Weight (Typical)	700g	

### Applications

Widely used for the industry application that requests precise adjustment of temperature.

### Outline Dimensions&LED

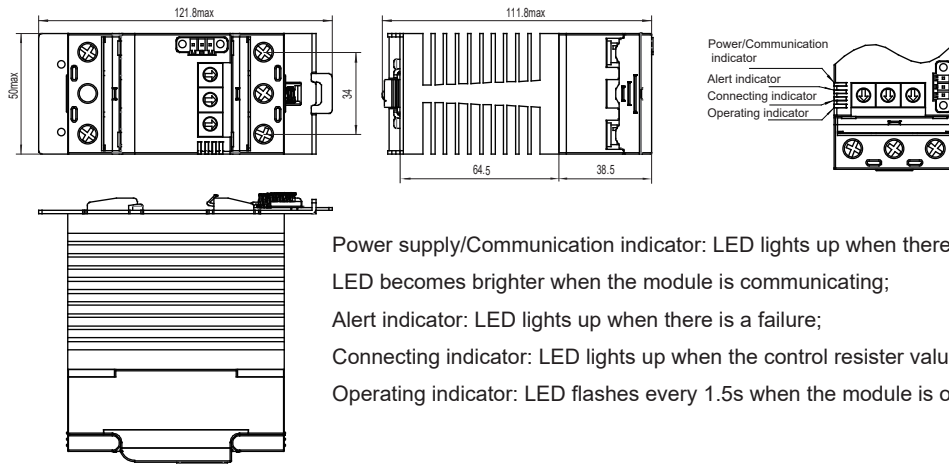

### Wiring Diagram

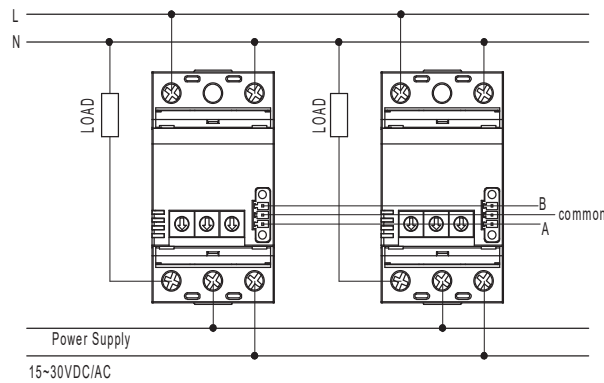

### Output/Proportional Control Features

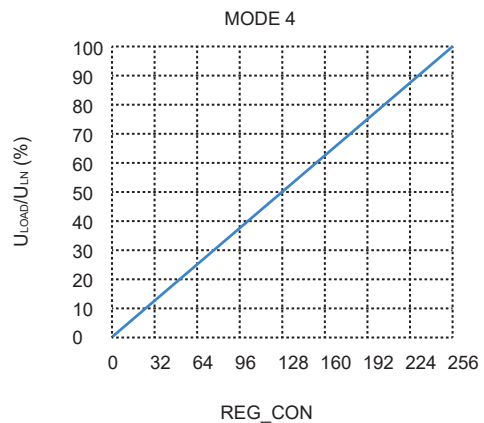
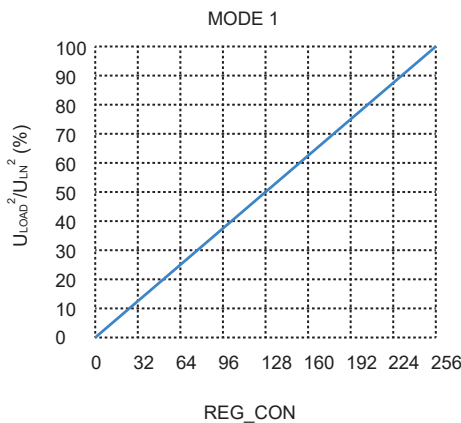

Output/Proportional Control Features

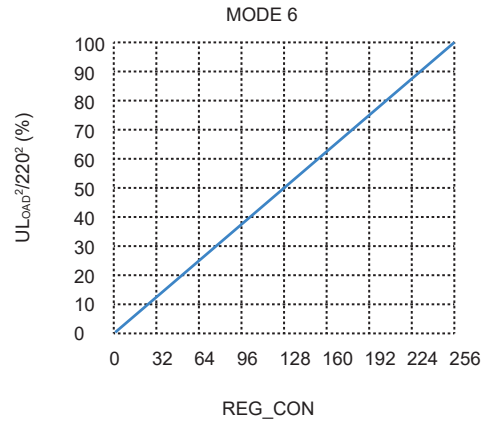
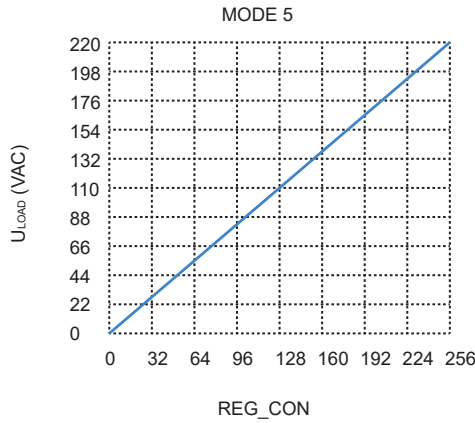

Output/Proportion control Characteristic

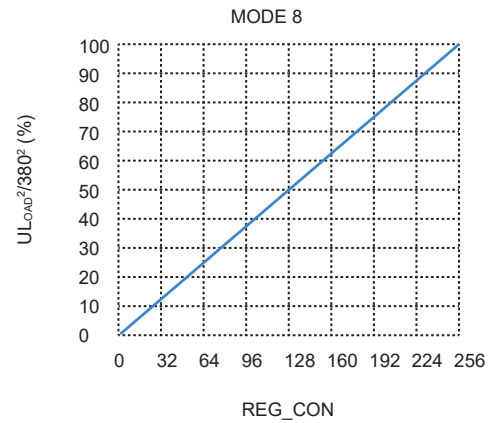
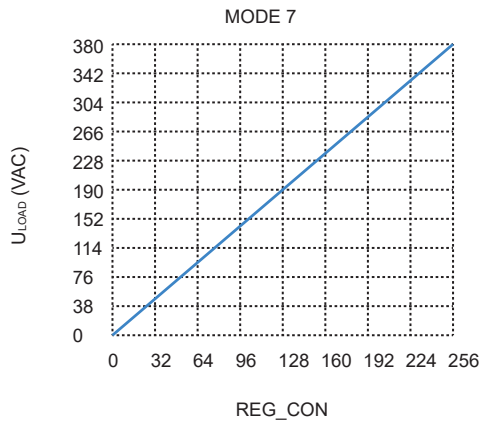

Thermal Derating Curve

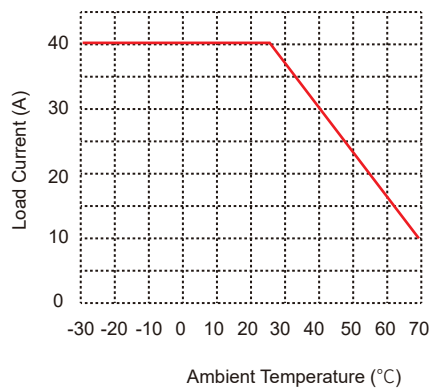

General Notes

1. Relay must be mounted to proper sized heat sink based on thermal curves. Thermal grease or a thermal pad must be used between relay and heat sink and be torqued down to 18-20/2.0-2.2 in-lb/N·m.
2. When connection wiring to SSR please ensure screws are torqued down properly (input 13-15/1.5-1.7in/lb/N·m, output 18-20/2.0-2.2 in-lb/N·m).
3. When ambient temperature is above 25°C see thermal derating curve.

Warnings

1. The product's side panels may be hot, allow the product to cool before touching.
2. Disconnect all power before installing or working with this equipment.
3. Verify all connections and replace all covers before turning on power.