

Product Description

- ◆ Din Rail Mount
- ◆ Integrated Fast Fuse Protection
- ◆ LED Indicator: a Blown Fuse  
SSR Failure or Load Disconnection
- ◆ RoHS Compliant



Ordering Information

DR	A	- 8	K <sup>(1)</sup>	- KSD480D5-W (037)	(XXX)
DR Series	A: Mould A	1: 1 Channel 2: 2 Channel 4: 4 Channel 8: 8 Channel	A: Common Anode K: Common Cathode	SSR -KSD*** -KSF*** -KSLE***	Customized Code

Note:

- (1) DRA-1 series products and DRA-2 series products have no A or K options.  
 (2) Limited by terminal current carrying capacity, the maximum load current of DRA-1 series products is 10A.  
 (3) Limited by the spacing between SSRs above the module, the load current of DRA-2 series products, DRA-4 series products and DRA-8 series products should be less than 50% of the rated load current when they are used. And the maximum load current does not exceed 5A.

DRA-1-KSD

	5A	
L:4-15VDC	DRA-1-KSD480D5-L (037)	DRA-1-KSD480D5R-L (037)
H:15-32VDC	DRA-1-KSD480D5-H (037)	DRA-1-KSD480D5R-H (037)
W:4-32VDC	DRA-1-KSD480D5-W (037)	DRA-1-KSD480D5R-W (037)

DRA-1-KSLE

	3A	5A	10A	20A
L:3-10VDC	DRA-1-KSLE400D3-L	DRA-1-KSLE200D5-L	DRA-1-KSLE100D10-L	DRA-1-KSLE60D20-L
H:10-28VDC	DRA-1-KSLE400D3-H	DRA-1-KSLE200D5-H	DRA-1-KSLE100D10-H	DRA-1-KSLE60D20-H

DRA-1-KSF

	48	100
5:4-6VDC	DRA-1-KSF48D5-5	DRA-1-KSF100D5-5
12:9-14.4VDC	DRA-1-KSF48D5-12	DRA-1-KSF100D5-12
24:19.2-28.8VDC	DRA-1-KSF48D5-24	DRA-1-KSF100D5-24
W:4-32VDC	DRA-1-KSF48D5-W	DRA-1-KSF100D5-W

Ordering Information

DRA-2-KSD

	3A	5A
L:4-15VDC	DRA-2-KSD480D5-L (037)	DRA-2-KSD480D5R-L (037)
H:15-32VDC	DRA-2-KSD480D5-H (037)	DRA-2-KSD480D5R-H (037)
W:4-32VDC	DRA-2-KSD480D5-W (037)	DRA-2-KSD480D5R-W (037)

DRA-2-KSLE

	3A	5A	10A	20A
L:3-10VDC	DRA-2-KSLE400D3-L	DRA-2-KSLE200D5-L	DRA-2-KSLE100D10-L	DRA-2-KSLE60D20-L
H:10-28VDC	DRA-2-KSLE400D3-H	DRA-2-KSLE200D5-H	DRA-2-KSLE100D10-H	DRA-2-KSLE60D20-H

DRA-2-KSF

	48	100
5:4-6VDC	DRA-2-KSF48D5-5	DRA-2-KSF100D5-5
12:9.6-14.4VDC	DRA-2-KSF48D5-12	DRA-2-KSF100D5-12
24:19.2-28.8VDC	DRA-2-KSF48D5-24	DRA-2-KSF100D5-24
W:4-32VDC	DRA-2-KSF48D5-W	DRA-2-KSF100D5-W

DRA-4-KSD

	5A	
L:4-15VDC	DRA-4K-KSD480D5-L (037)	DRA-4K-KSD480D5R-L (037)
	DRA-4A-KSD480D5-L (037)	DRA-4A-KSD480D5R-L (037)
H:15-32VDC	DRA-4A-KSD480D5-H (037)	DRA-4A-KSD480D5R-H (037)
	DRA-4K-KSD480D5-H (037)	DRA-4K-KSD480D5R-H (037)
W:4-32VDC	DRA-4K-KSD480D5-W (037)	DRA-4K-KSD480D5R-W (037)
	DRA-4A-KSD480D5-W (037)	DRA-4A-KSD480D5R-W (037)

DRA-4-KSLE

	3A	5A	10A	20A
L:3-10VDC	DRA-4K-KSLE400D3-L	DRA-4K-KSLE200D5-L	DRA-4K-KSLE100D10-L	DRA-4K-KSLE60D20-L
	DRA-4A-KSLE400D3-L	DRA-4A-KSLE200D5-L	DRA-4A-KSLE100D10-L	DRA-4A-KSLE60D20-L
H:10-28VDC	DRA-4K-KSLE400D3-H	DRA-4K-KSLE200D5-H	DRA-4K-KSLE100D10-H	DRA-4K-KSLE60D20-H
	DRA-4A-KSLE400D3-H	DRA-4A-KSLE200D5-H	DRA-4A-KSLE100D10-H	DRA-4A-KSLE60D20-H

Ordering Information

DRA-4-KSF

	48		100	
5:4-6VDC	DRA-4K-KSF48D5-5	DRA-4A-KSF48D5-5	DRA-4K-KSF100D5-5	DRA-4A-KSF100D5-5
12:9.6-14.4VDC	DRA-4K-KSF48D5-12	DRA-4A-KSF48D5-12	DRA-4K-KSF100D5-12	DRA-4A-KSF100D5-12
24:19.2-28.8VDC	DRA-4K-KSF48D5-24	DRA-4A-KSF48D5-24	DRA-4K-KSF100D5-24	DRA-4A-KSF100D5-24
W:4-32VDC	DRA-4K-KSF48D5-W	DRA-4A-KSF48D5-W	DRA-4K-KSF100D5-W	DRA-4A-KSF100D5-W

DRA-8-KSD

	5A	
L:4-15VDC	DRA-8K-KSD480D5-L (037)	DRA-8K-KSD480D5R-L (037)
	DRA-8A-KSD480D5-L (037)	DRA-8A-KSD480D5R-L (037)
H:15-32VDC	DRA-8K-KSD480D5-H (037)	DRA-8K-KSD480D5R-H (037)
	DRA-8A-KSD480D5-H (037)	DRA-8A-KSD480D5R-H (037)
W:4-32VDC	DRA-8K-KSD480D5-W (037)	DRA-8K-KSD480D5R-W (037)
	DRA-8A-KSD480D5-W (037)	DRA-8A-KSD480D5R-W (037)

DRA-8-KSLE

	3A	5A	10A	20A
L:3-10VDC	DRA-8K-KSLE400D3-L	DRA-8K-KSLE200D5-L	DRA-8K-KSLE100D10-L	DRA-8K-KSLE60D20-L
	DRA-8A-KSLE400D3-L	DRA-8A-KSLE200D5-L	DRA-8A-KSLE100D10-L	DRA-8A-KSLE60D20-L
H:10-28VDC	DRA-8K-KSLE400D3-H	DRA-8K-KSLE200D5-H	DRA-8K-KSLE100D10-H	DRA-8K-KSLE60D20-H
	DRA-8A-KSLE400D3-H	DRA-8A-KSLE200D5-H	DRA-8A-KSLE100D10-H	DRA-8A-KSLE60D20-H

DRA-8-KSF

	48		100	
5:4-6VDC	DRA-8K-KSF48D5-5	DRA-8A-KSF48D5-5	DRA-8K-KSF100D5-5	DRA-8A-KSF100D5-5
12:9.6-14.4VDC	DRA-8K-KSF48D5-12	DRA-8A-KSF48D5-12	DRA-8K-KSF100D5-12	DRA-8A-KSF100D5-12
24:19.2-28.8VDC	DRA-8K-KSF48D5-24	DRA-8A-KSF48D5-24	DRA-8K-KSF100D5-24	DRA-8A-KSF100D5-24
W:4-32VDC	DRA-8K-KSF48D5-W	DRA-8A-KSF48D5-W	DRA-8K-KSF100D5-W	DRA-8A-KSF100D5-W

Outline Dimensions

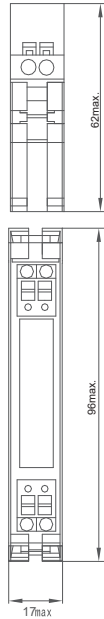

DRA-1 Series

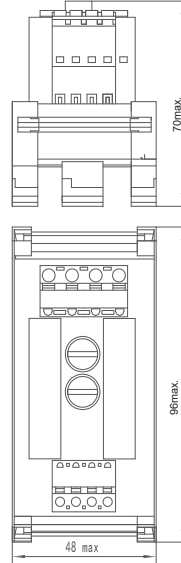

DRA-2 Series

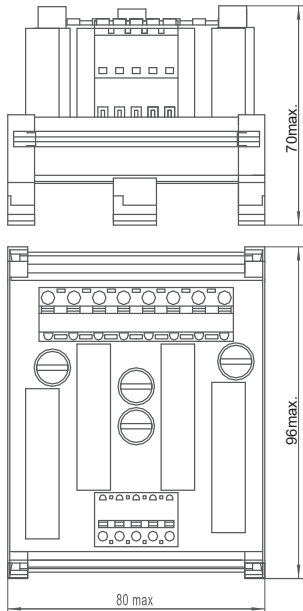

DRA-4 Series

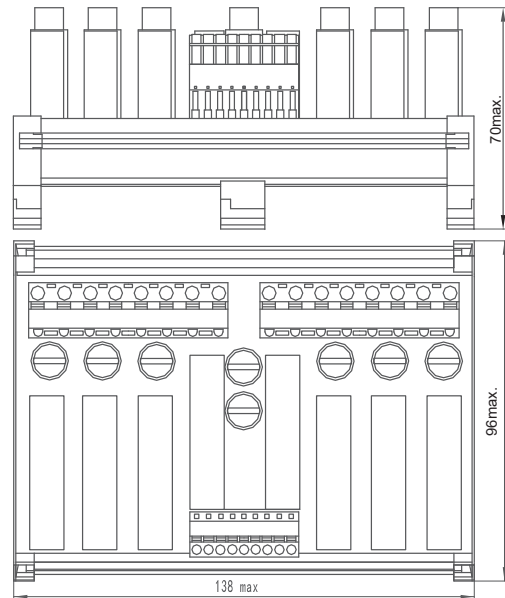

DRA-8 Series

Wiring Diagram



DRA-1-KSD Series Wiring Diagram



DRA-1-KSF/KSLE Series Wiring Diagram

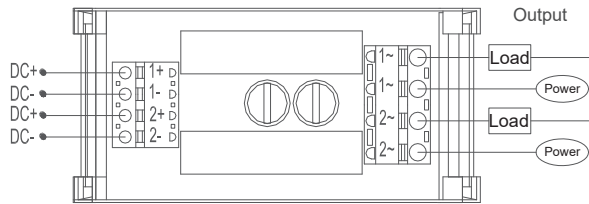

DRA-2-KSD Series Wiring Diagram

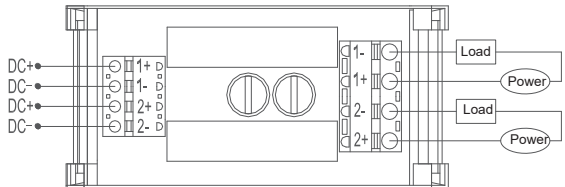

DRA-2-KSF/ KSLE Series Wiring Diagram

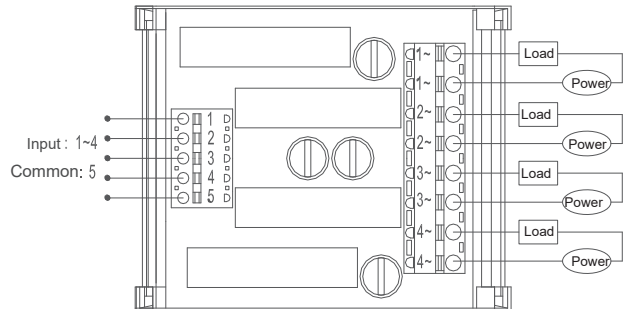

DRA-4A/K-KSD Series Wiring Diagram

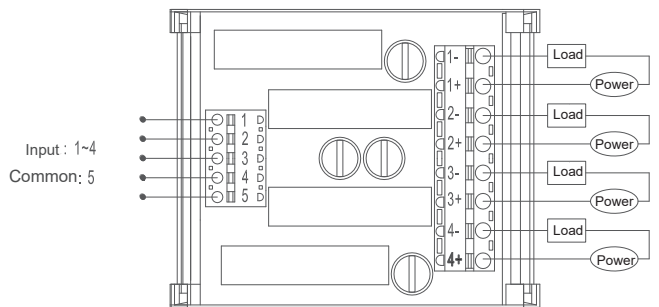

DRA-4A/K-KSF /KSLE Series Wiring Diagram

Wiring Diagram

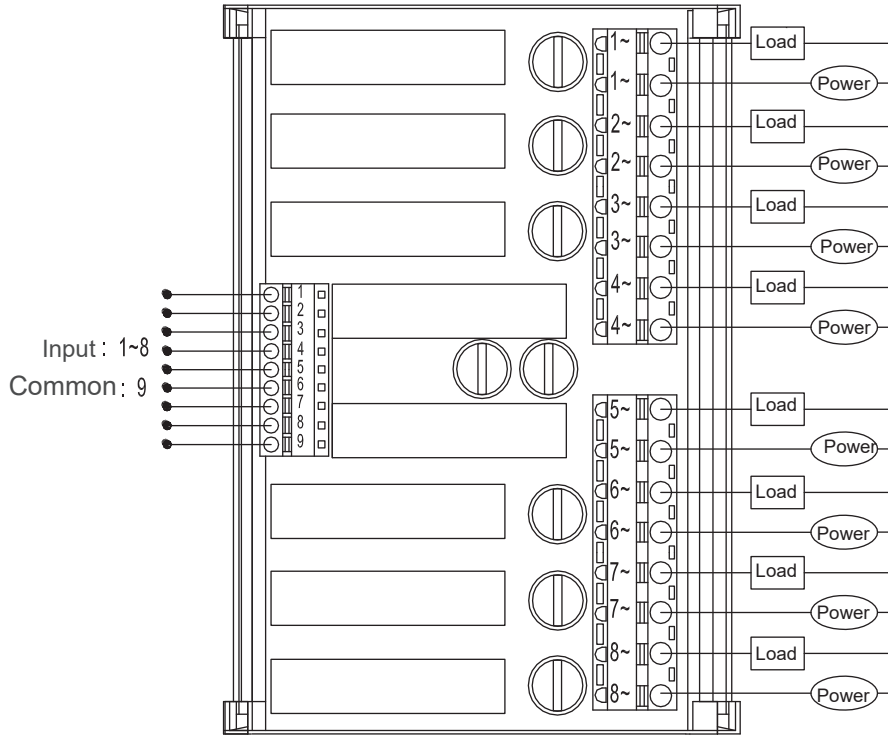

DRA-8A/ K-KSD Series  
Wiring Diagram

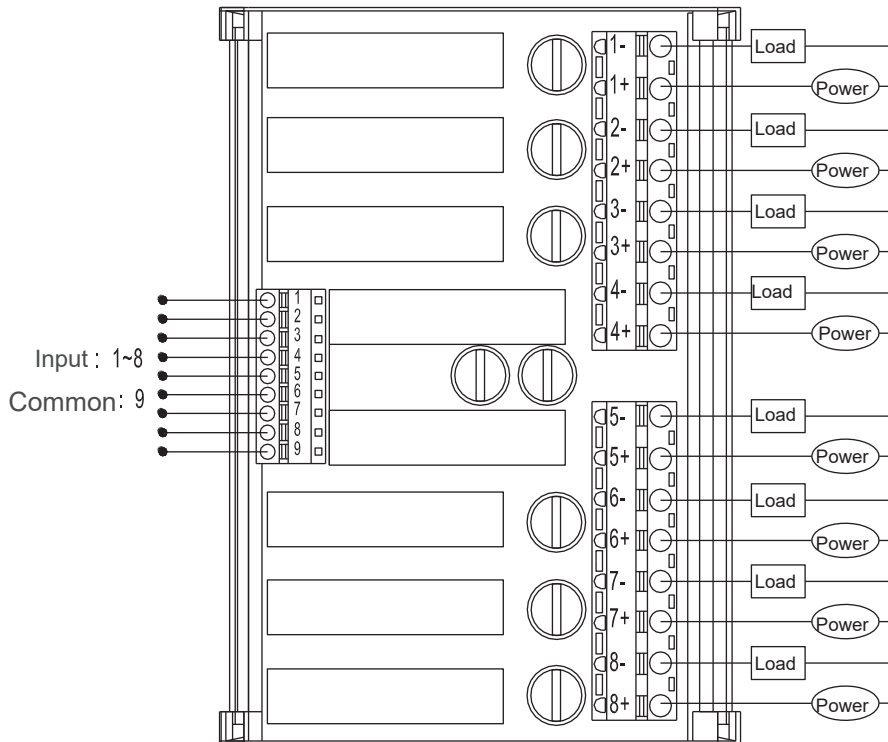

DRA-8A/ K-KSF /KSLE Series  
Wiring Diagram

**!** Warnings

1. The product's side panels may be hot, allow the product to cool before touching.
2. Disconnect all power before installing or working with this equipment.
3. Verify all connections and replace all covers before turning on power.