

Product Description

- ◆ Load Current: 0.1A-20A
- ◆ Rated Voltage: 60VDC,100VDC,200VDC,400VDC
- ◆ Control Voltage: 3-10VDC,10-28VDC
- ◆ 2500VACrms or4000VACrms Dielectric Strength
- ◆ Circuit Board Mounting Mode
- ◆ RoHS Compliant
- ◆ Transistor Output or MOSFET Output<sup>(1)</sup>



Note:(1) KSLE60D3 Series are Transistor Output, others are MOSFET Output.



Ordering Information

KSLE	60	D	20	-L	B	(XXX)
KSLE Series <sup>(2)</sup>	Load Voltage 60: 0-50VDC 100: 0-75VDC 200: 0-125VDC 400: 0-300VDC	DC Control	Load Current 3: 3Amp 5: 5Amp 10: 10Amp 20: 20Amp	Control Voltage L: 3-10VDC H: 10-28VDC	Output Type B: None:	Customized Code

(2) Part numbers available are listed in the table below.

Information	3A	5A	10A	20A
L	KSLE60D3-L	KSLE200D5-L	KSLE60D10-L	KSLE60D20-L
	KSLE400D3-L		KSLE100D10-L	
	KSLE60D3-LB		KSLE60D10-H	
H	KSLE60D3-H	KSLE200D5-H	KSLE60D10-H	KSLE60D20-H
	KSLE400D3-H		KSLE100D10-H	
	KSLE60D3-HB			

General Specifications

Input Specifications (Ta=25°C)			
Control Voltage Range	L		3-10VDC
	H		10-28VDC
Must Turn-On Voltage	KSLE***/L/H Series	L	3VDC
		H	10VDC
	KSLE***/LB/HB Series	L	1VDC
		H	1VDC
Must Turn-Off Voltage	KSLE***/L/H Series	L	1VDC
		H	1VDC
	KSLE***/LB/HB Series	L	3VDC
		H	10VDC
Maximum Input Current			20mA

Output Specifications (Ta=25°C)		
MOSFET Maximum Transient Overvoltage	KSLE60D(10- 20) Series	100Vpk
	KSLE100D10 Series	150Vpk
	KSLE200D5 Series	250Vpk
	KSLE400D3 Series	650Vpk
Transistor Maximum Transient Overvoltage	KSLE60D3 Series	80Vpk
Load Voltage Range	KSLE60D Series	0-50VDC
	KSLE100D Series	0-75VDC
	KSLE200D Series	0-125VDC
	KSLE400D Series	0-300VDC
TVS Protection Voltage (Typical)	KSLE60D Series	64.6-71.4VDC
	KSLE100D Series	105-116VDC
	KSLE200D Series	190-210VDC
	KSLE400D Series	418-462VDC
Maximum 1 Cycle Surge Current (50Hz)	KSLE400D3 Series	15A (@10ms)
	KSLE200D5 Series	25A (@10ms)
	KSLE(100/60)D10 Series	50A (@10ms)
	KSLE60D20 Series	100A (@10ms)
	KSLE60D3 Series	5A (@1s)
Maximum Turn-On Time		1ms
Maximum Turn-Off Time		1ms
Maximum Off-State Leakage Current @Rated Load Voltage	Transistor output	1mA
	MOSFET Output	0.1mA
On-state Resistance	KSLE400D3 Series	200mΩ(@Tj=25 C, Typical)
		400mΩ(@Tj=125 C, Maximum)
	KSLE200D5 Series	60mΩ(@Tj=25 C, Typical)
		150mΩ(@Tj=125 C, Maximum)
	KSLE100D10 Series	11mΩ(@Tj=25 C, Typical)
		38mΩ(@Tj=125 C, Maximum)
KSLE60D10 Series	10mΩ(@Tj=25 C, Typical)	
	30mΩ(@Tj=125 C, Maximum)	
KSLE60D20 Series	4mΩ(@Tj=25 C, Typical)	
	10mΩ(@Tj=125 C, Maximum)	
Maximum On-voltage Drop	KSLE60D3 Series	1.5VDC
General Specifications (Ta=25°C)		
Minimum Insulation Resistance (@500VDC)		1000MΩ (@500VDC)
Dielectric Strength (Input-Output, 50Hz/60Hz)	Transistor output	4000Vrms
	MOSFET Output	2500Vrms
Ambient Temperature Range		-30 C ~ +80 C
Storage Temperature Range		-30 C ~ +100 C
Weight (Typical)		20g

Outline Dimensions

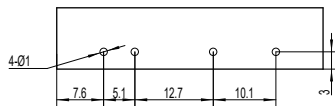

The bottom view

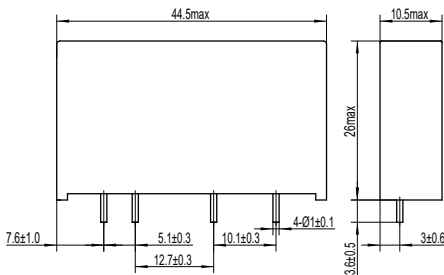

KSLEXXXD(3- 5- 10) Series

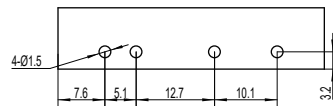

The bottom view

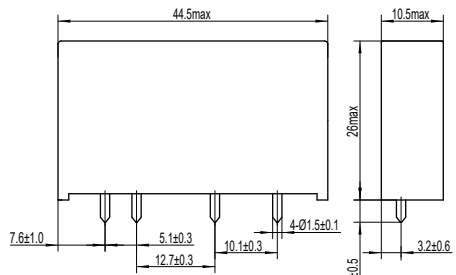

KSLEXXXD20 Series

Wiring Diagram

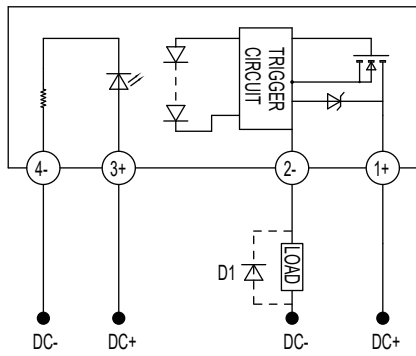

Note: When the relay is used for inductive load control, please be sure to use a suppression circuit, just like the drawing above. Both load terminals are inverse paralleled with a fly-wheel diode D1.  
D1: Fast Recovery Diode

Thermal Derating Curve

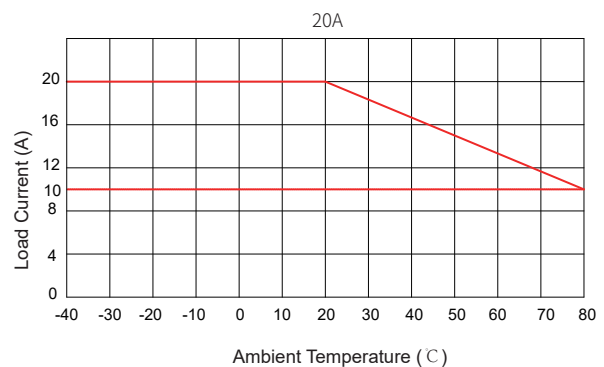
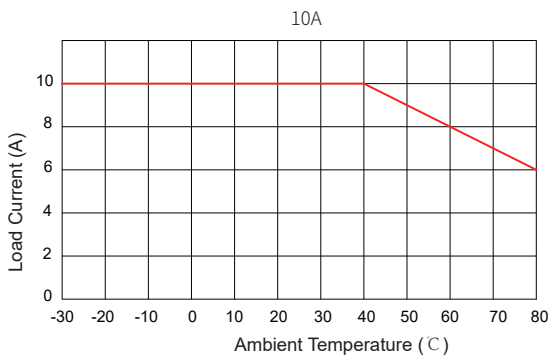
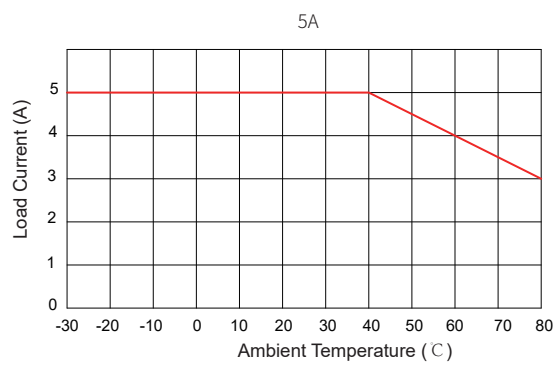
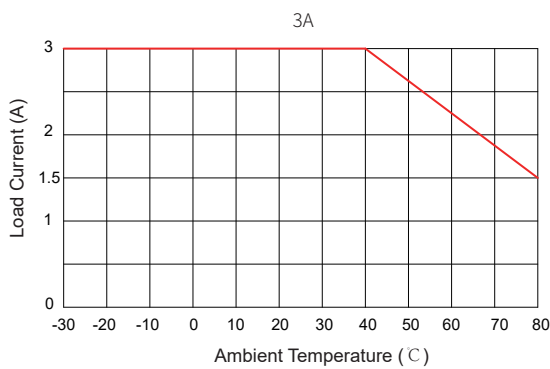

General Notes

1. Soldering must be finished within 10 seconds at 260 °C, or finished within 5 seconds at 350 °C. Otherwise, it may cause damage to the relay.
2. Terminal polarity must be observed. Otherwise, it may cause damage to the relay.
3. When ambient temperature is above 25 °C, the maximum load current decreases. See thermal derating curve.
4. Capacitive load will produce very high surge current at the moment of conduction, which may lead to the damage of solid state relay due to the excessive surge current. Therefore, if the actual load is capacitive, or the load has paralleled large capacitance, it is strongly recommended that NTC should be connected in series in the load loop to suppress surge current in order to avoid damage to the product.

Warnings

1. The product's side panels may be hot, allow the product to cool before touching.
2. Disconnect all power before installing or working with this equipment.
3. Verify all connections and replace all covers before turning on power.