

YFA 永豐

佛山市南海永豐鋁型材有限公司

FOSHAN CITY NANHAI YONGFENG ALUMINIUM CO.,LTD.

地址：中国广东省佛山市南海区大沥谢边工业区

ADD : Xiebian Industrial Area, Dali Town, Nanhai District,

Foshan City, Guangdong, China

电话 / TEL : +86-757-85535511 85565511 85566711

传真 / FAX : +86-757-85520011 邮编 / P.C : 528231

E-mail: yfa@yfa. tm

Http://www.yfa. tm

ALUMINIUM LOUVER



ABOUT YFA.

Foshan City Nanhai Yongfeng Aluminum Co., Ltd. was founded and risen in Dali Town of Nanhai District of Foshan City – China Nonferrous Metal Production Base. Started from the former Nanhai City Xiebian Yongfeng Aluminum Profile Factory (founded in October 1995), the Company restructured into limited company in November 2002.

By experiencing up and downs in the market competitions for more than a decade, Yongfeng had forged a complete production system from product design, extrusion, painting and profile forming, and established the product mix and market strategy that is based on aluminum profiles and led by aluminum products.

Though not having a long-standing history like a century enterprise, by virtue of Yongfeng People's perseverant pursuit of development, and edified under the decorous enterprise culture "Try my best to do", Yongfeng People constantly strive to become stronger and keeps continuous innovation. In future, Yongfeng shall retain and carry out the spirit of "Do the best", provides the employees, customer and partners with a sustainable platform advancing with time, and build the future together!



ABOUT HISTORY.

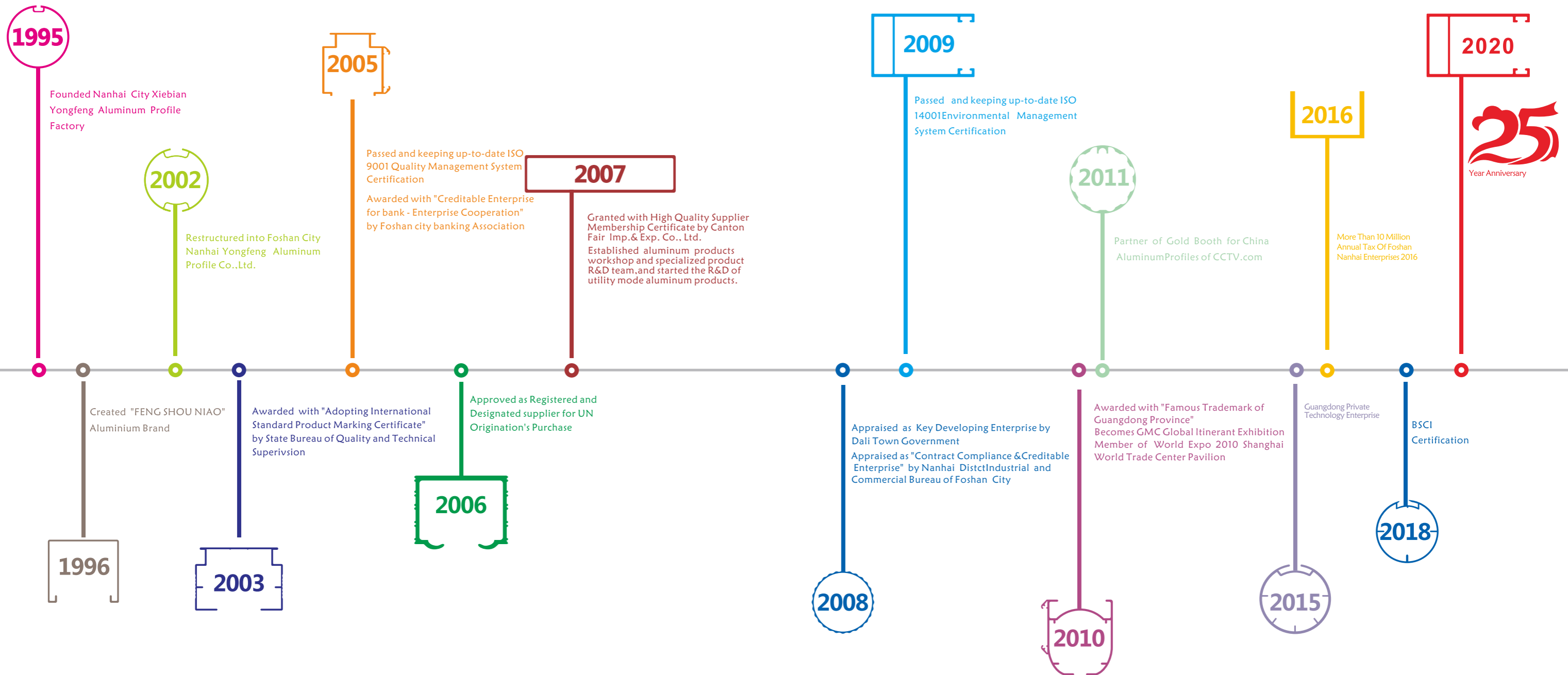



ABOUT ALUMINUM PRODUCTS

1. Safety Protection

Each type of aluminum products passed safety test, having a high level of safety protection performance, and the each type of aluminum products made of aluminum alloy profile has excellent performance on hardness, impact resistance etc. aspects which could serve with good safe protection effect.

2. Energy Conservation And Environment-friendly

All products are energy saving type, no rusting and corrosion in using process, and no secondary pollution in later period reconditioning. The product surface is treated with powder spraying, reaching the quality assurance of no decoloring for 10-20 years, which is very suitable for outdoor applications, meanwhile, various sun shading products could be served to regulate the light and the temperature of the surroundings, and reduce the power consumption greatly.

3. Fashionable And Beautiful

The product is of novel design, coordinated with abundant colors and easy mounting, which could match the overall visual effect of various project.

4. High Technology Contents

The products are with high level technologies, many patents are supplied in the physical products, and gained recognition from international market for its technology contents, reduce the powder consumption greatly.

ABOUT ALUMINIUM LOUVER APPLICATION



best application in townhouse and units



ABOUT ALUMINIUM LOUVER APPLICATION



best application in apartment



ABOUT ALUMINIUM LOUVER APPLICATION



best application in shool and industrial areal





CONTENTS

1	OUTDOOR SHUTTER.....	01-22
2	WINDOW HOOD	23-30
3	SLIDING LOUVER	31-52
4	BI-FOLDING LOUVER.....	53-70
5	SUNSHADE LOUVER	71-94
6	SUNSCREEN	95-102
7	PERFORATED SCREEN.....	103-112
8	VENTILATOR	113-140
9	TRILLER	141-148
10	ROOF PERGOLA.....	149-164
11	SIGNATURE PORJECTS.....	165-180

☆ Fixed shutter, operable blades, fit between floor and ceiling

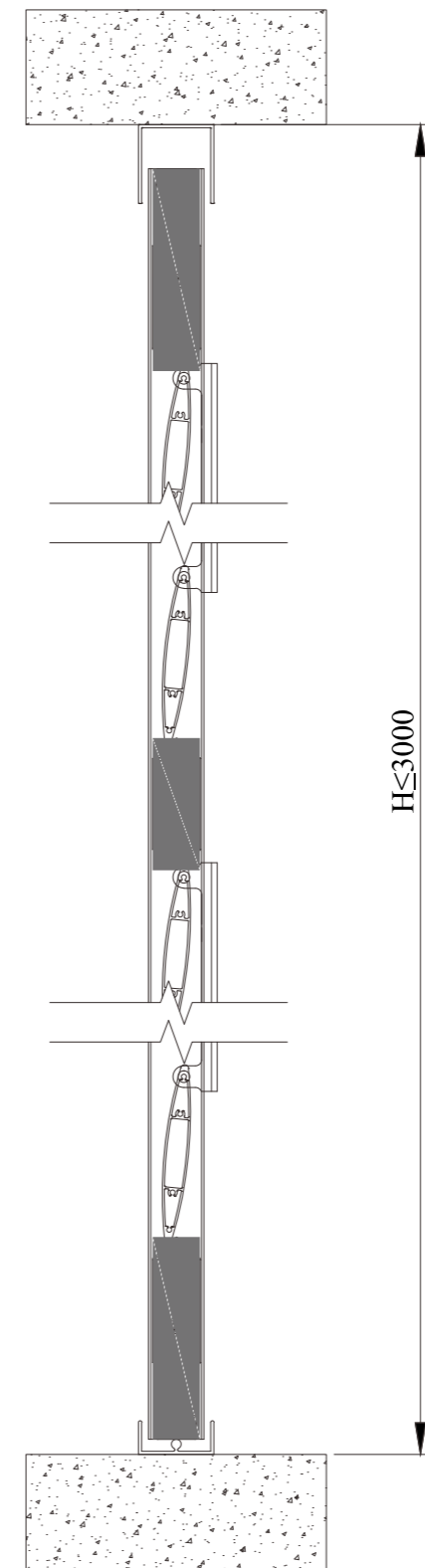
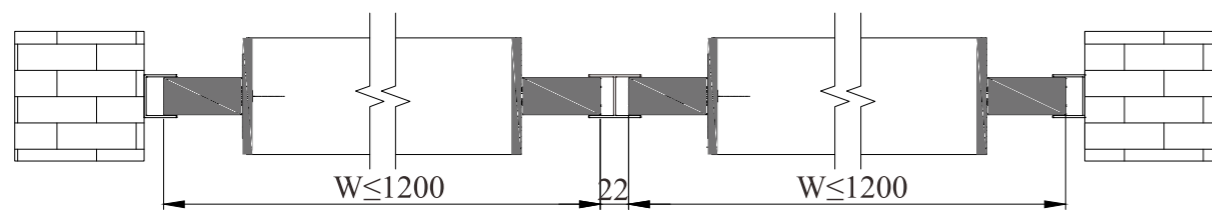

Optional blades

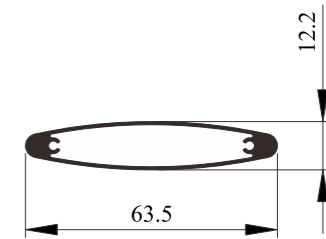

4237491

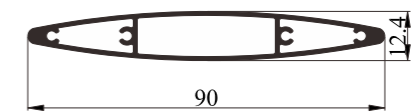

4237528

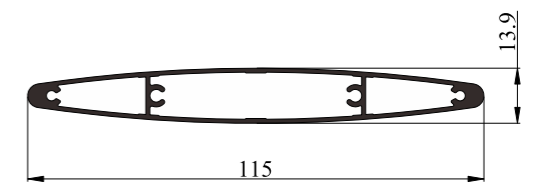

4237405

This design is assembly delivery.



☆ Bi-folding shutter, operable blades, fit between floor and ceiling

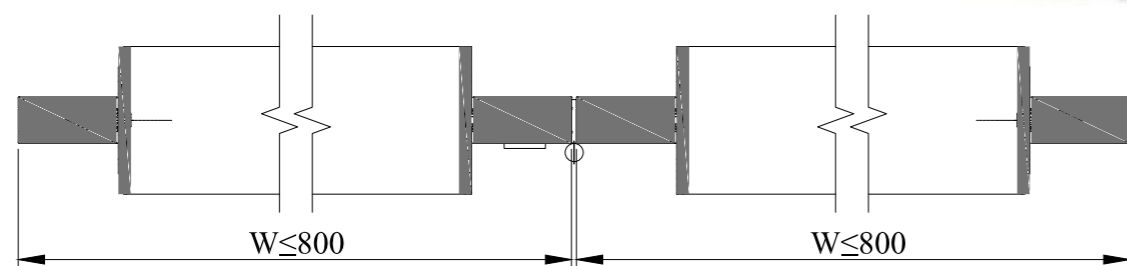

folding way

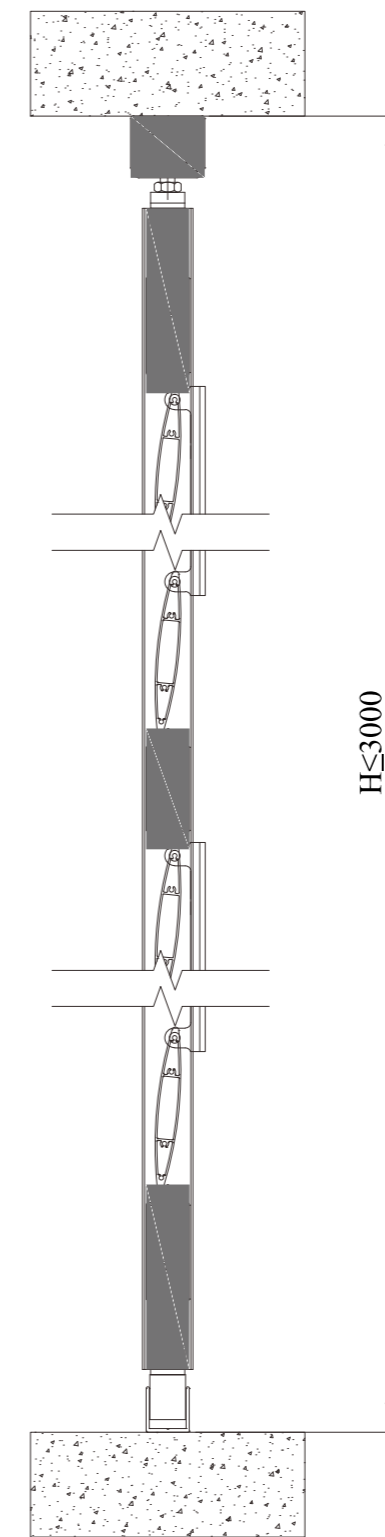

Optional blades

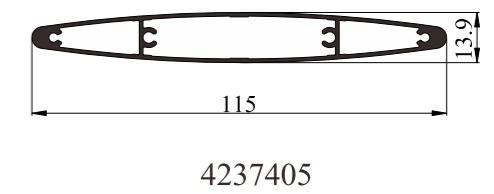
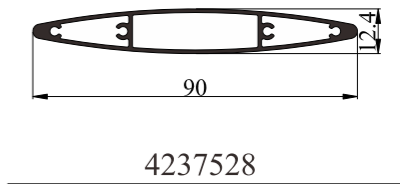
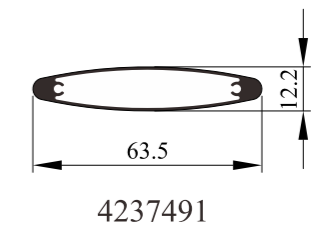

This design is assembly delivery.



☆ Sliding shutter with bottom rolling wheels, operable blades, fit between floor and ceiling

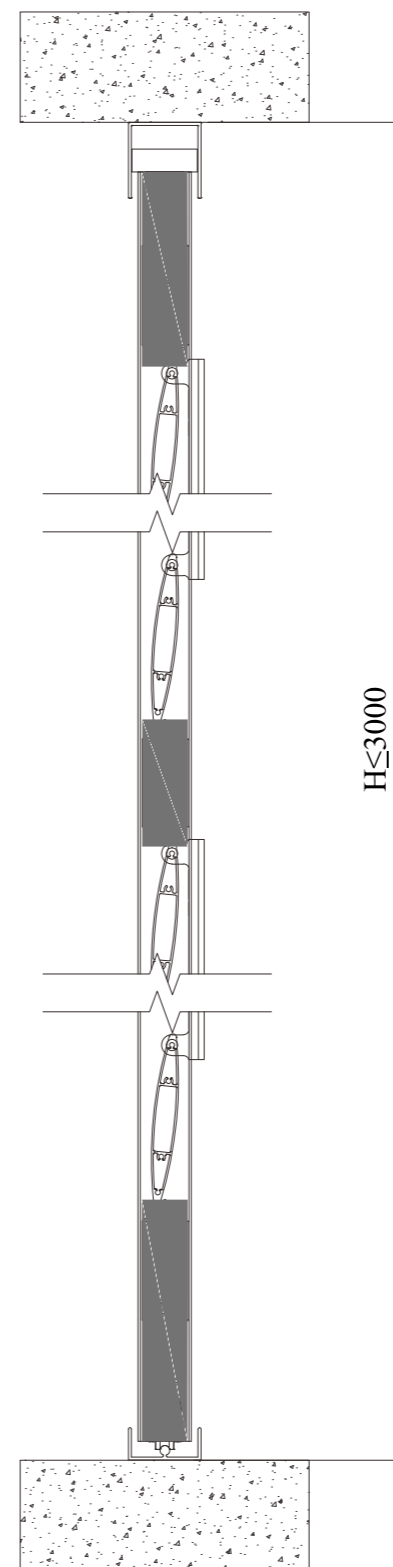
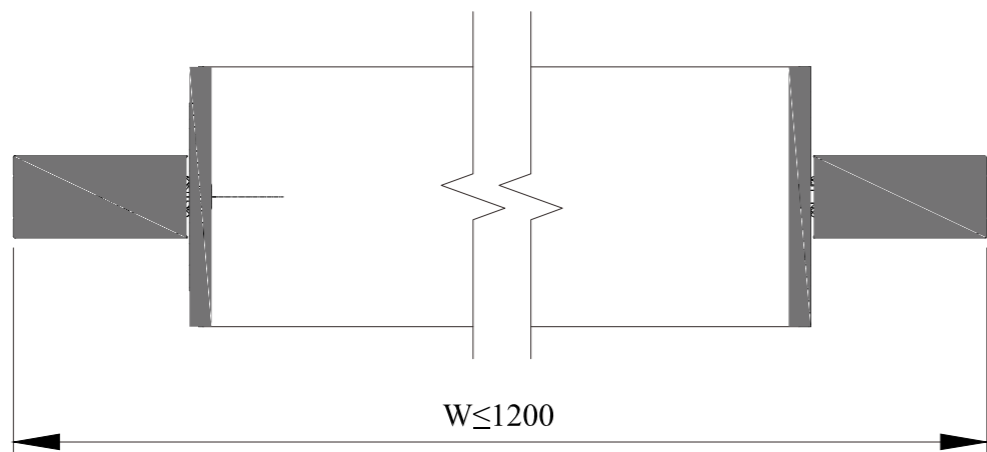

This design is assembly delivery.

Optional blades

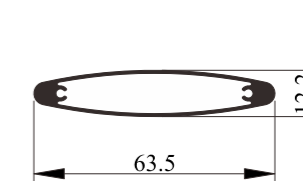

4237491

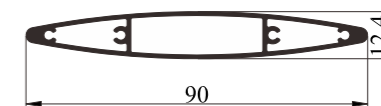

4237528



4237405

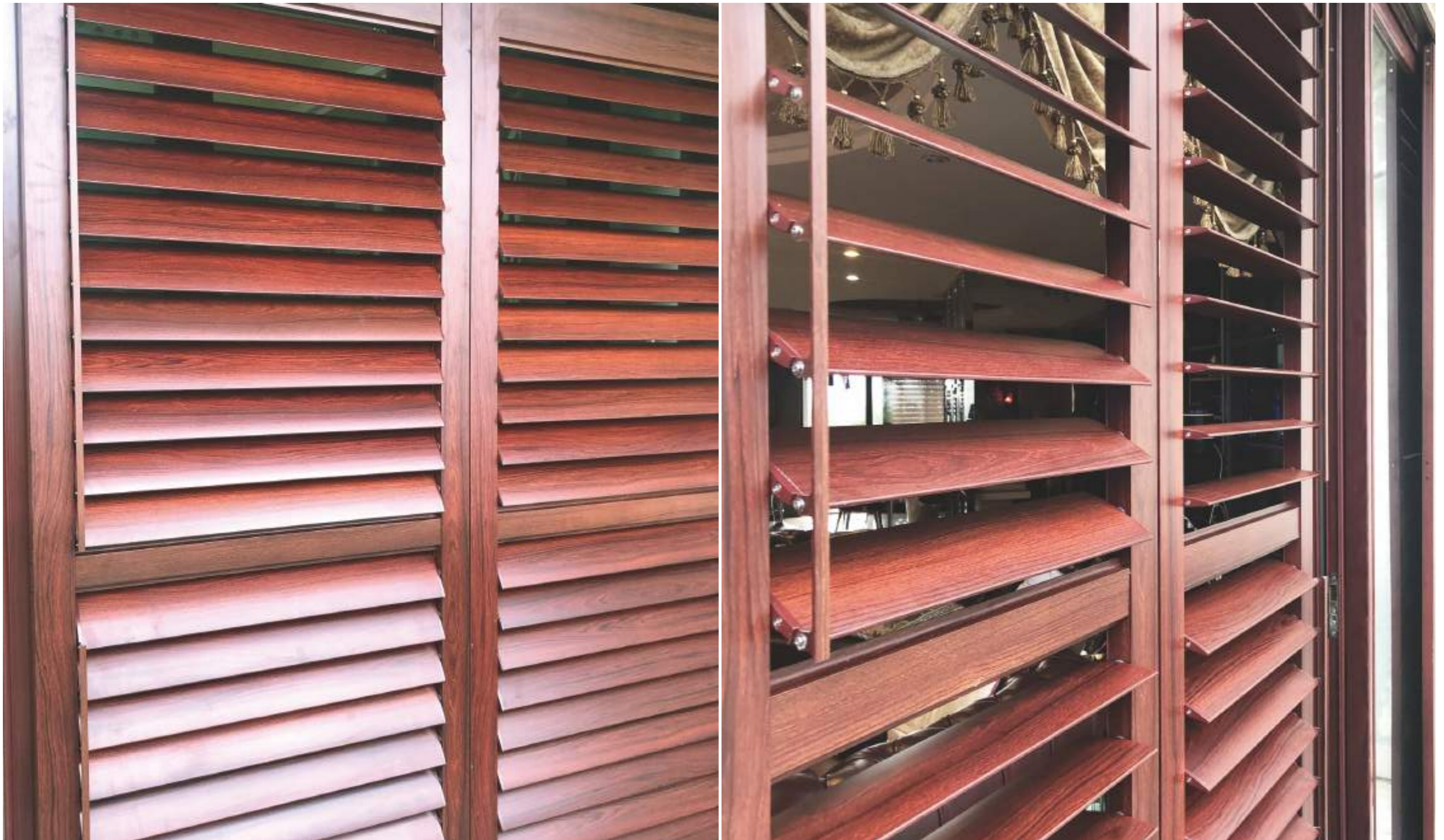

☆ Sliding shutter with top hang wheels, operable blades, fit between floor and ceiling

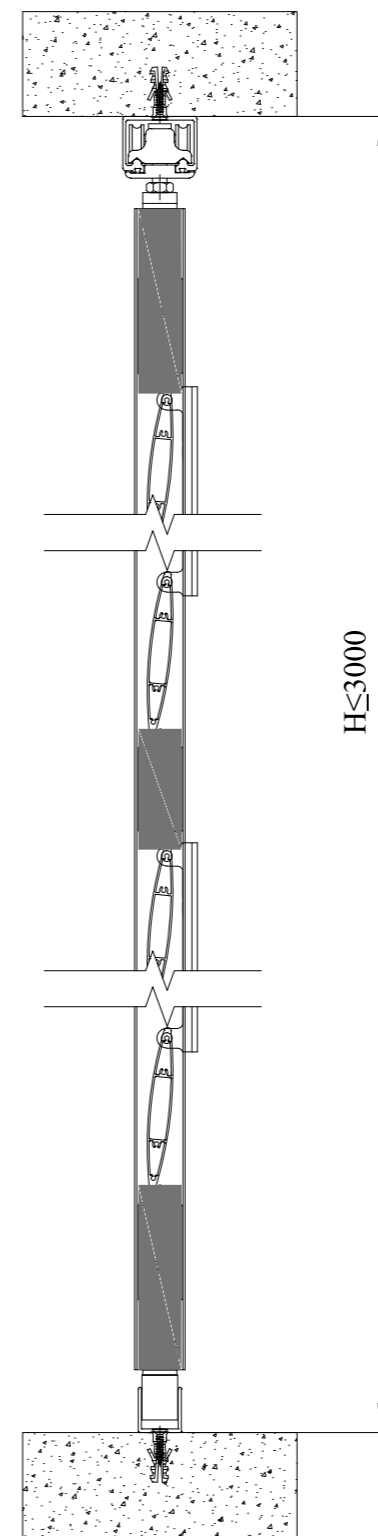
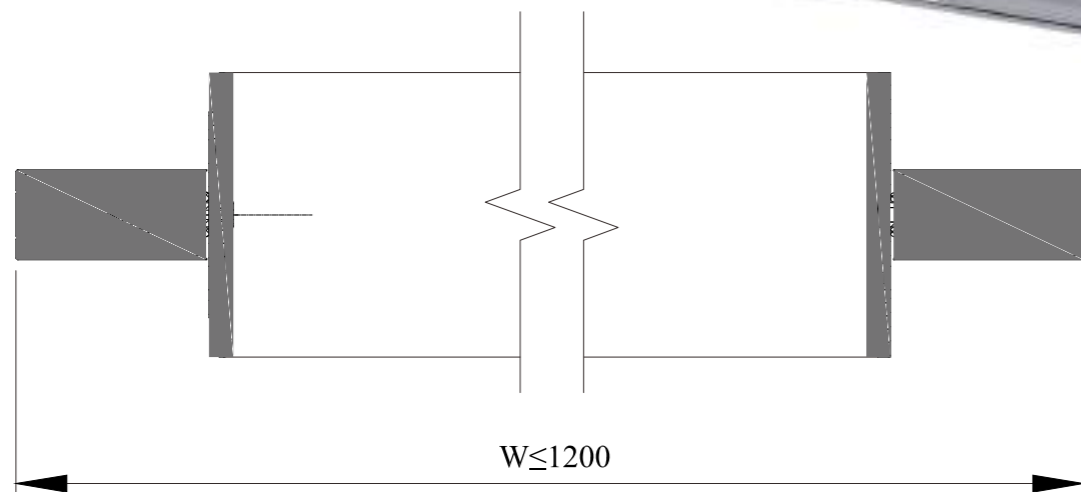

Optional blades

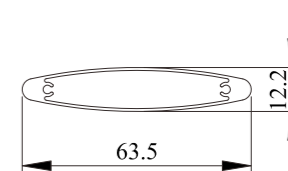

4237491

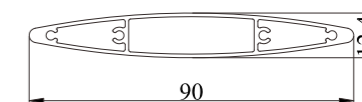

4237528

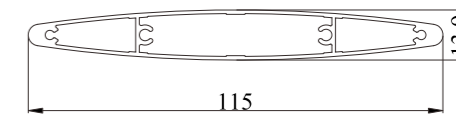

4237405

This design is assembly delivery.

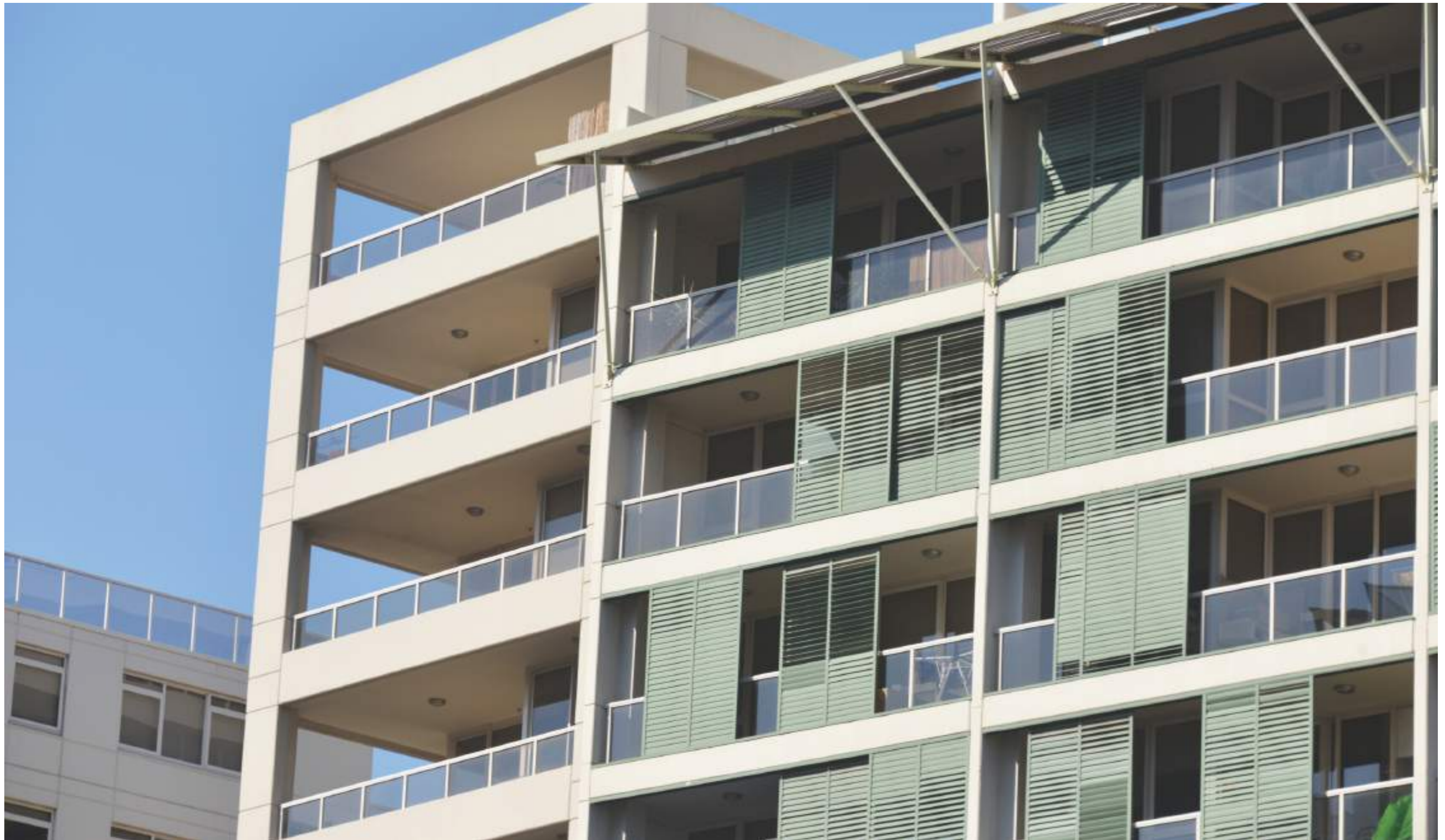

☆ L Frame shutter, fit between walls

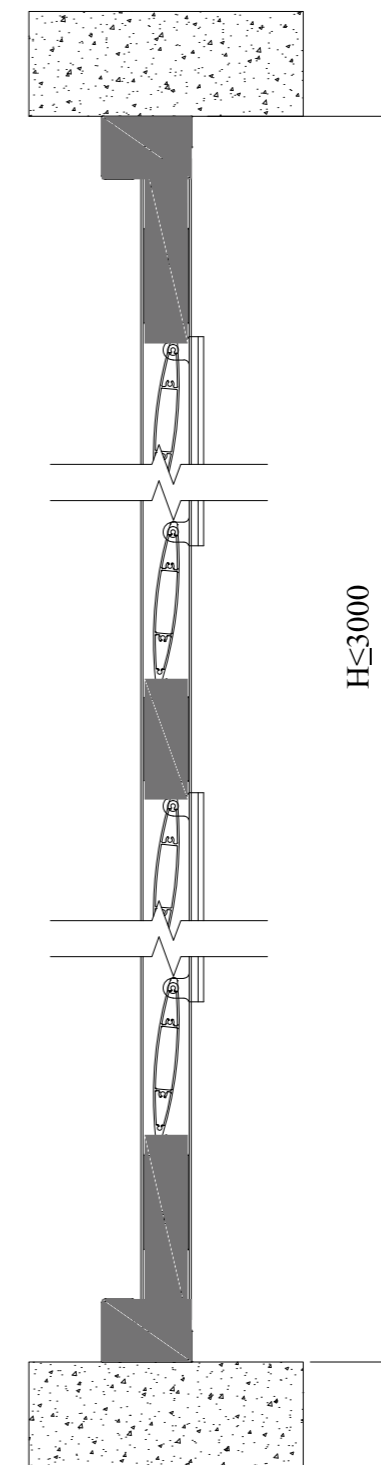
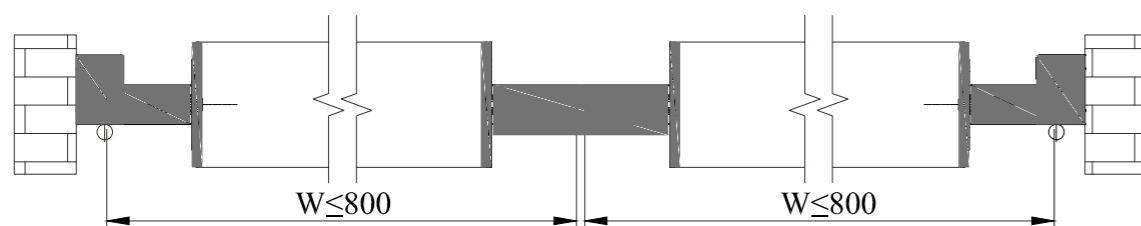

Optional blades

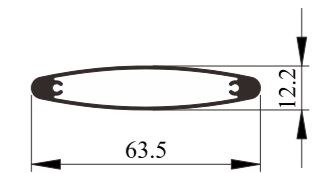

4237491

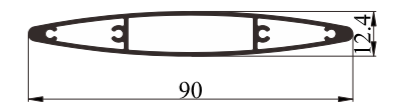

4237528

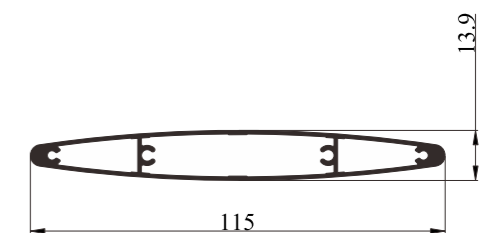

4237405

This design is assembly delivery.

☆ Z Frame shutter, fit between walls

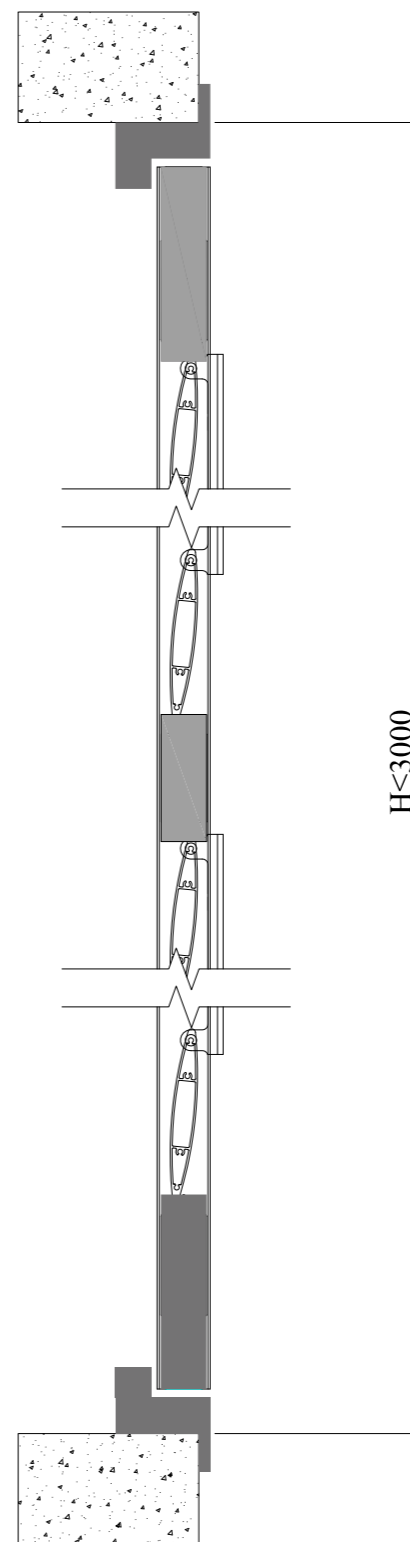
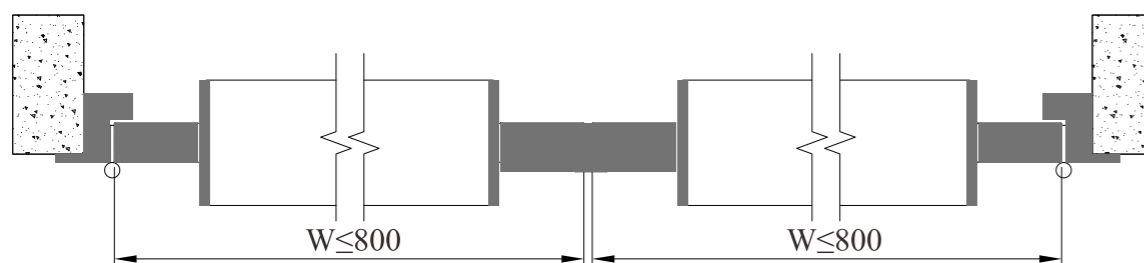

Optional blades

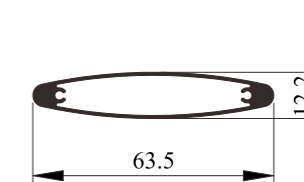

4237491

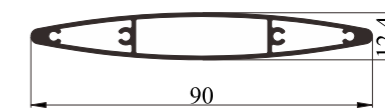

4237528



4237405

This design is assembly delivery.



☆50x50mm as frame, fixed square blades, face fit on walls

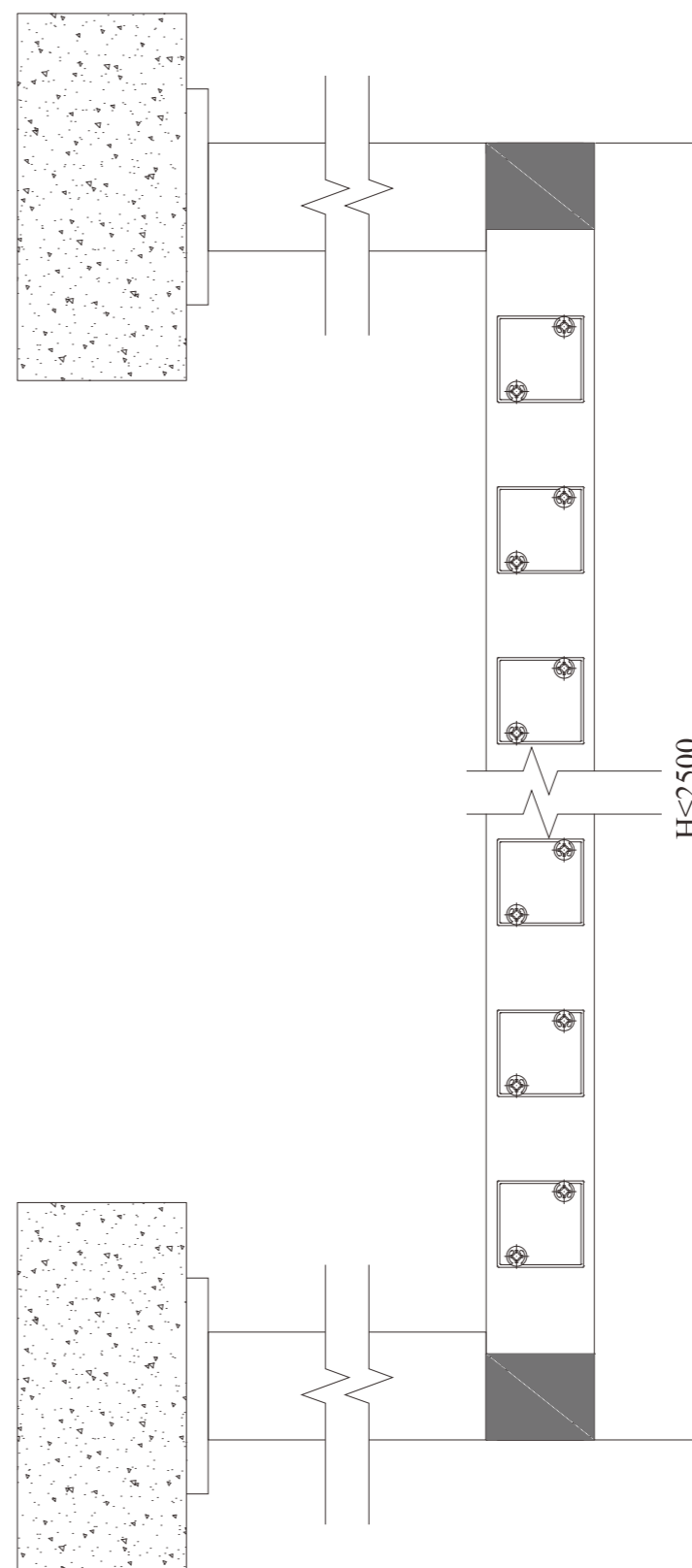

Optional blades

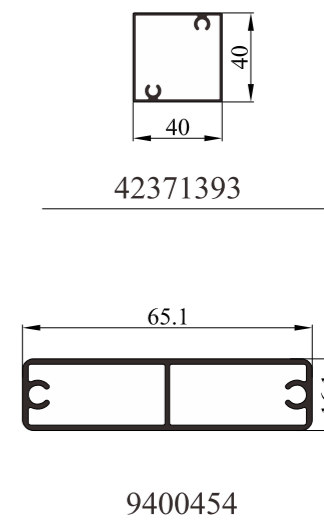

This design can be kits loose pack delivery or assembly delivery.



☆50x50mm as frame, fixed elliptical blades, face fit on walls

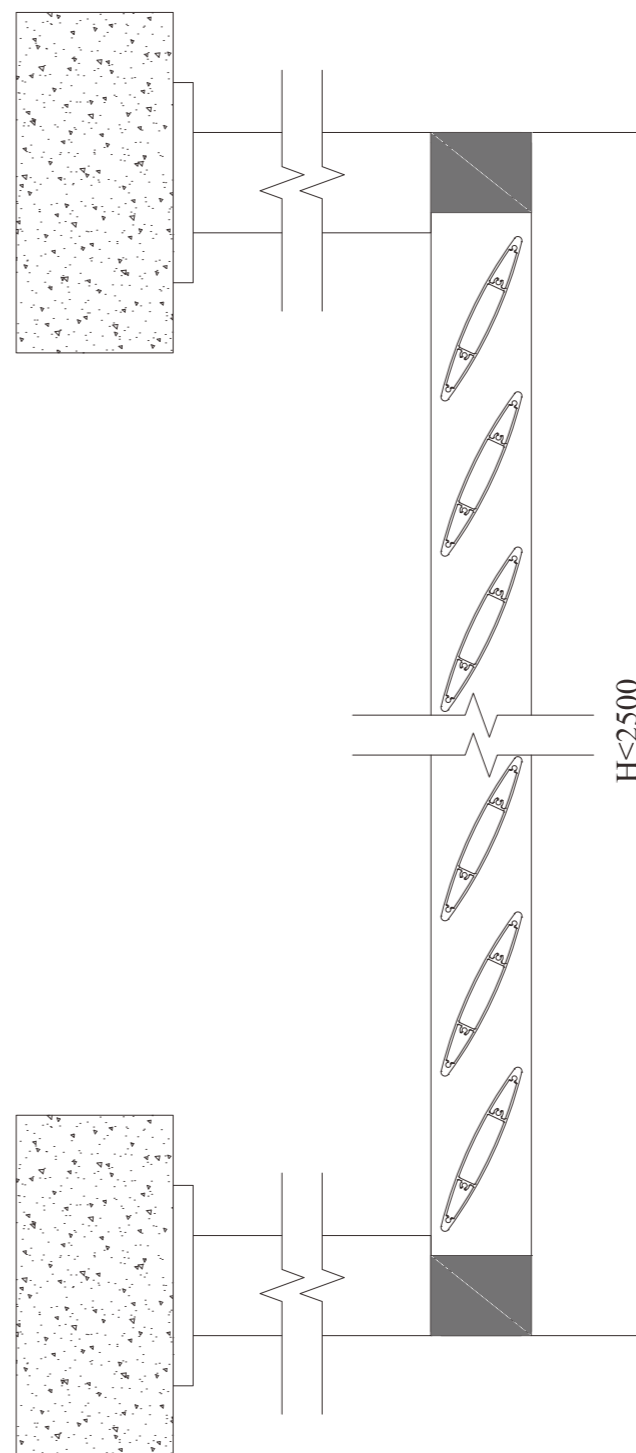

Optional blades

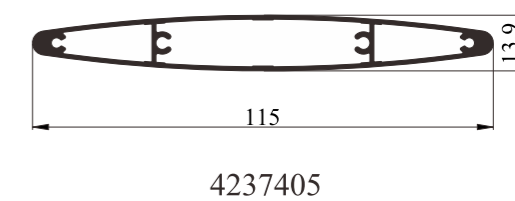
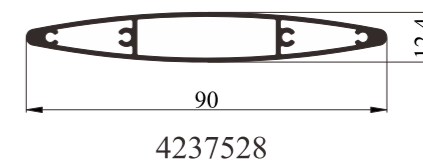
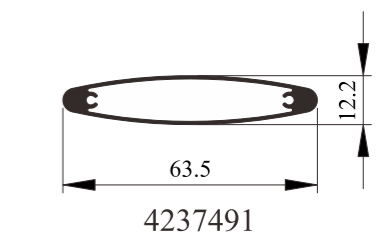

This design can be kits loose pack delivery or assembly delivery.



☆50x50mm as frame, fixed square blades, fit between floor and ceiling

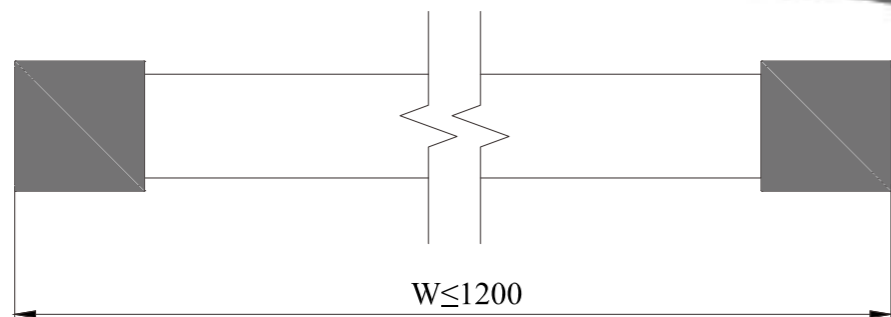

Any pitch is available.

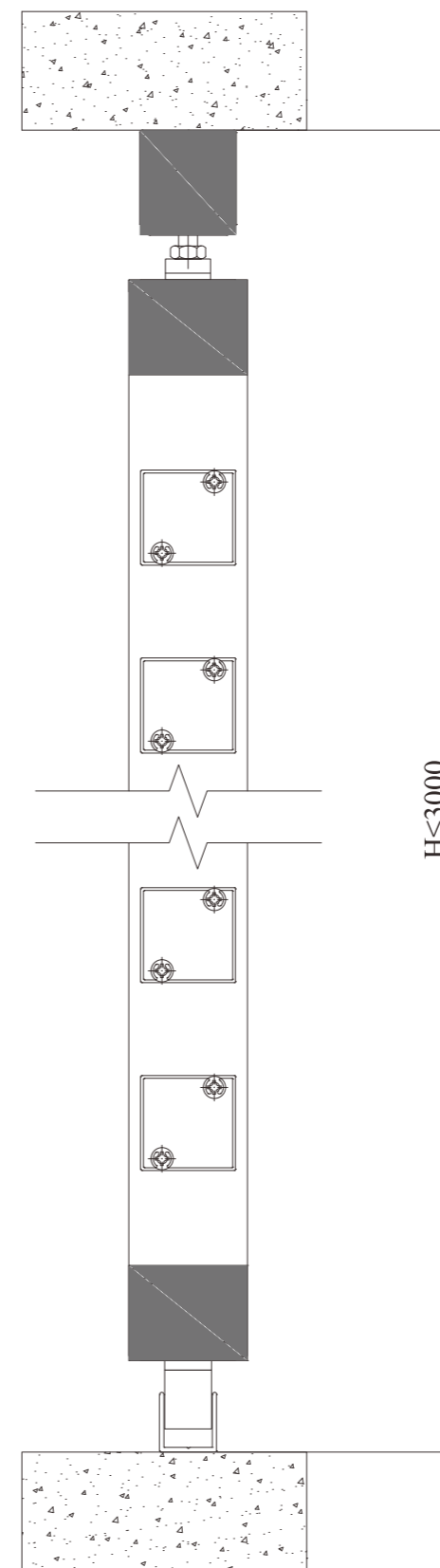

This design is assembly delivery.

Optional blades

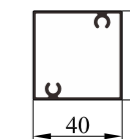

42371393

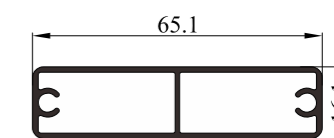

9400454

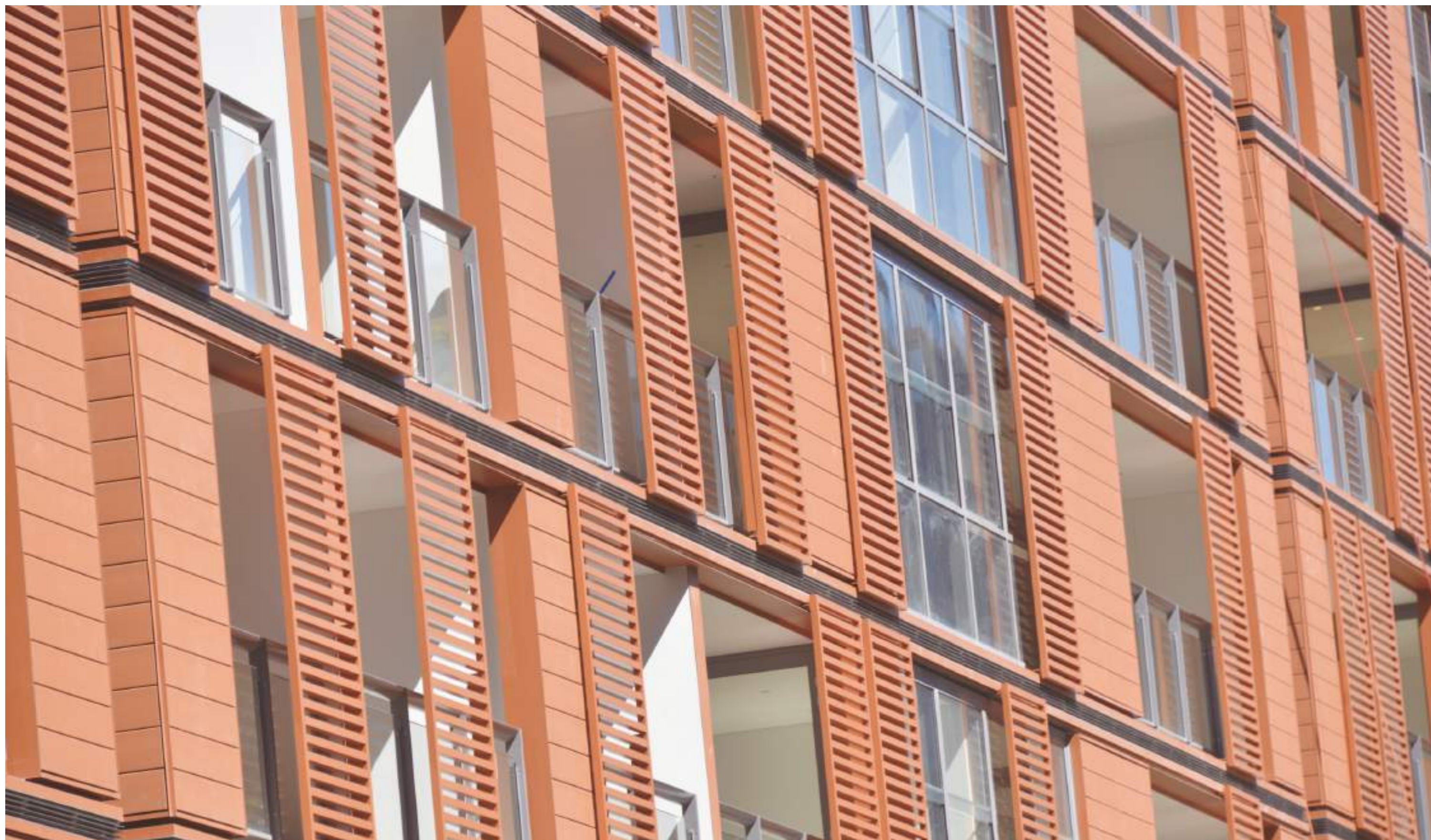

☆50x50mm as frame, fixed elliptical blades, fit between floor and ceiling

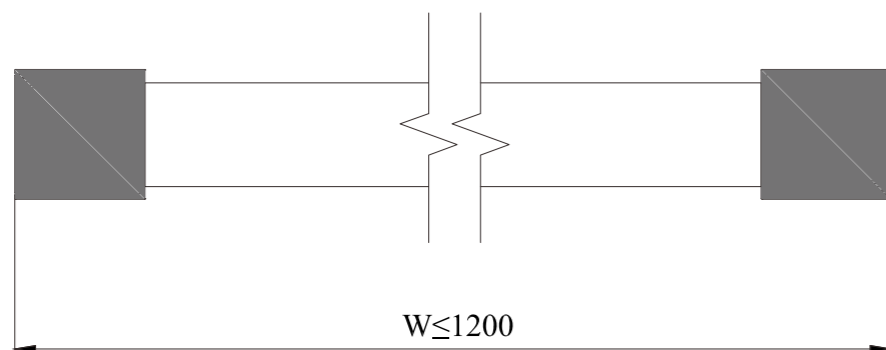

Any pitch is available.

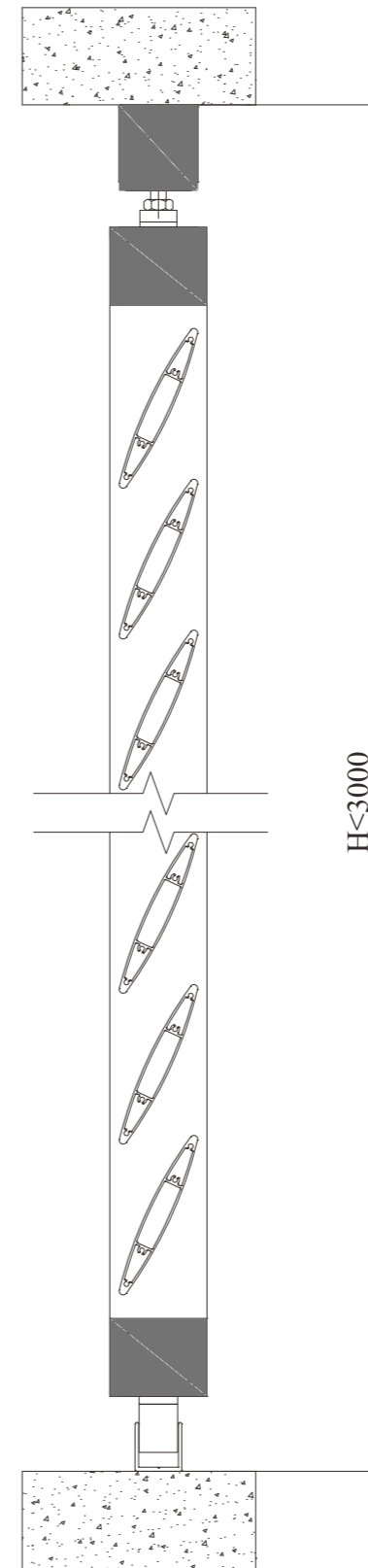

This design is assembly delivery.

Optional blades

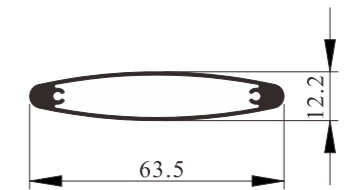

4237491

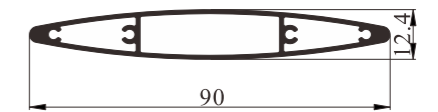

4237528

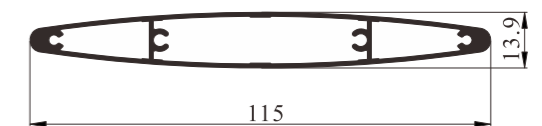

4237405



☆50x50mm as frame, operable elliptical blades, fit between floor and ceiling

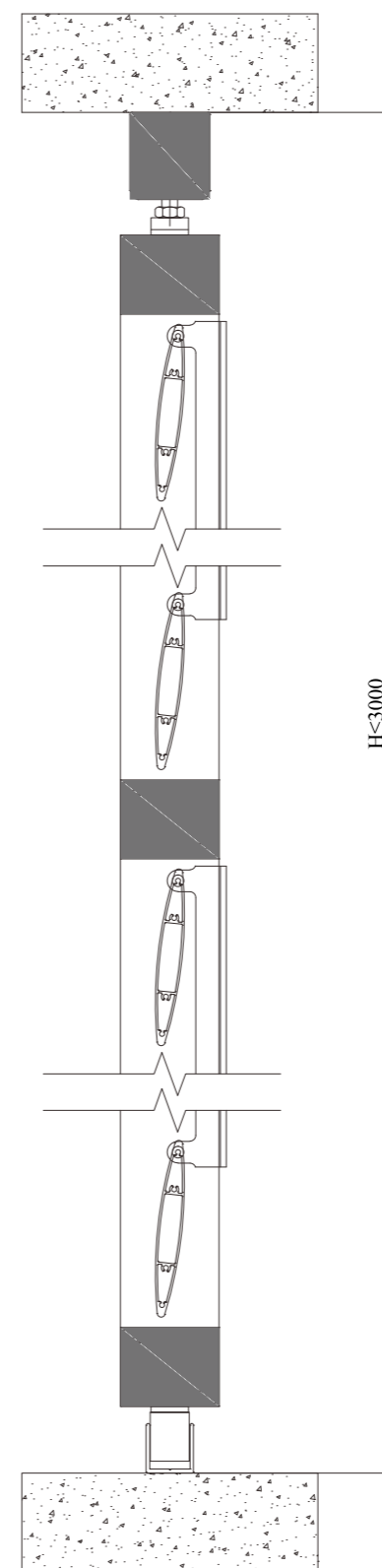
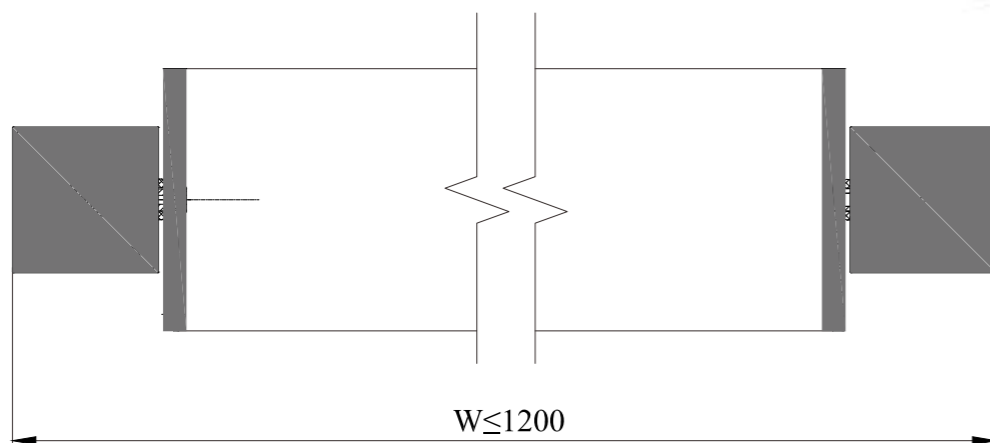

Optional blades

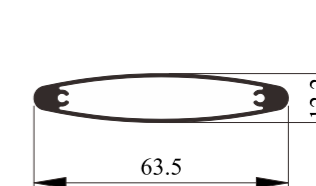

4237491

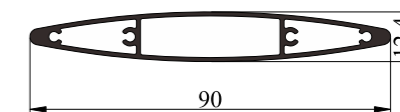

4237528



4237405

This design is assembly delivery.



☆50x36mm as frame, operable elliptical blades, fit between floor and ceiling

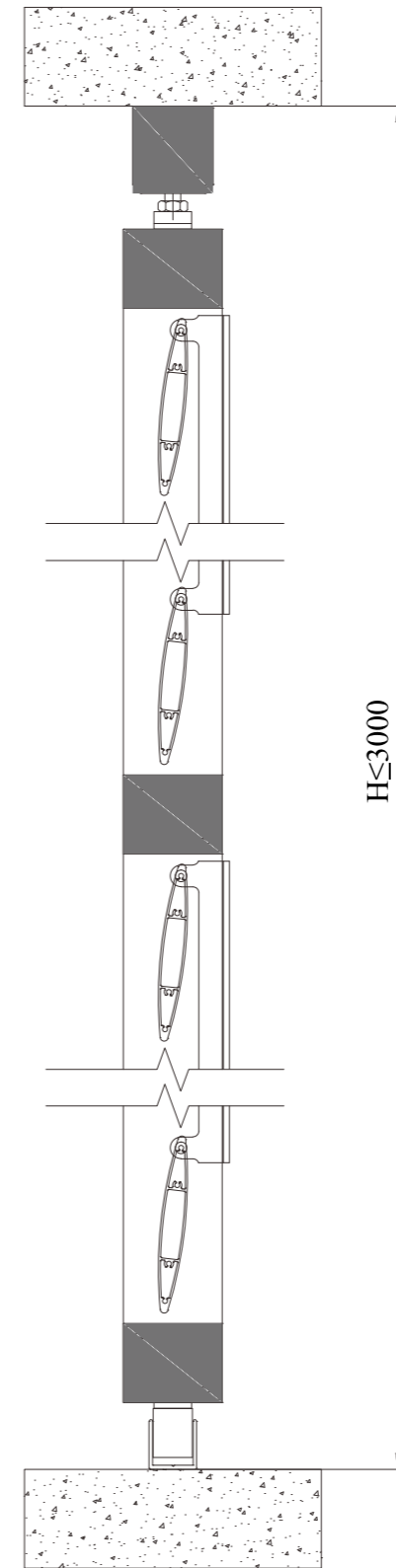
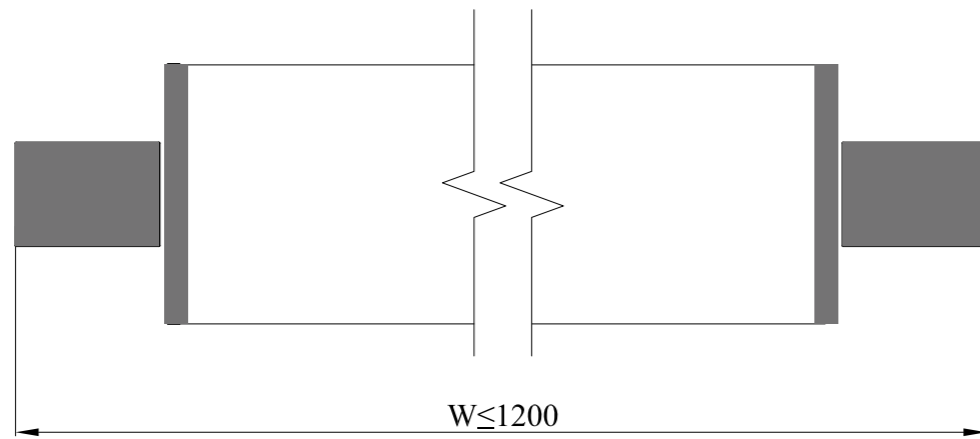

Optional blades

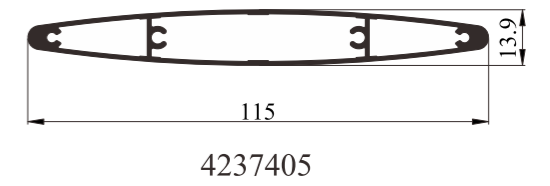
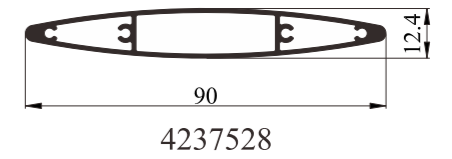
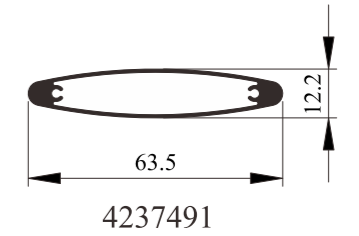

This design is assembly delivery.



☆60x28mm as frame, aluminium perforated sheet, fit between floor and ceiling

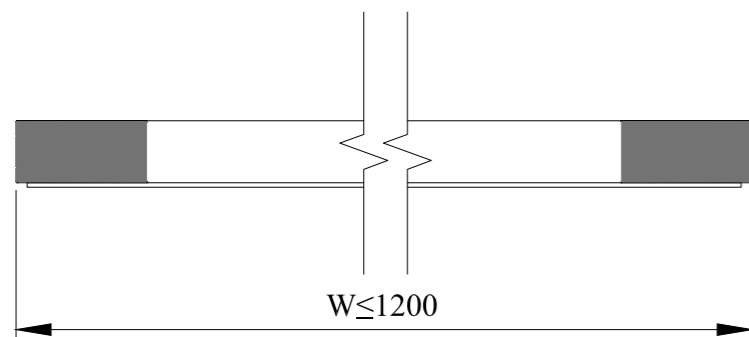
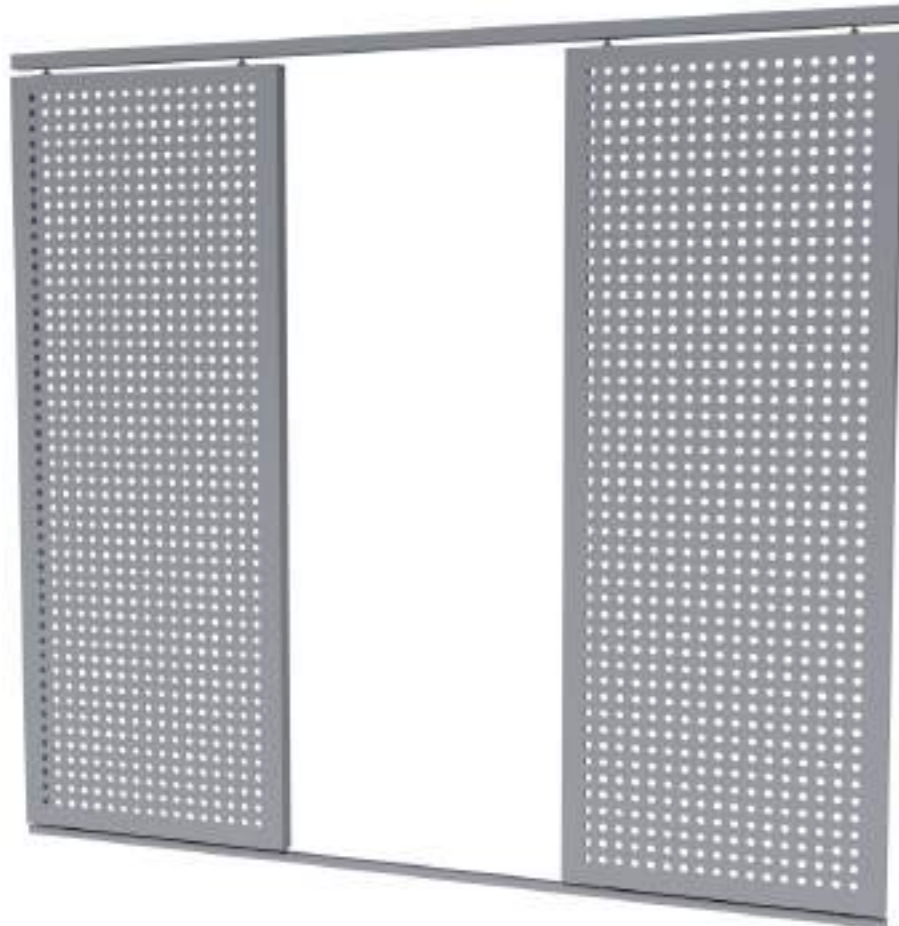

This design is assembly delivery.

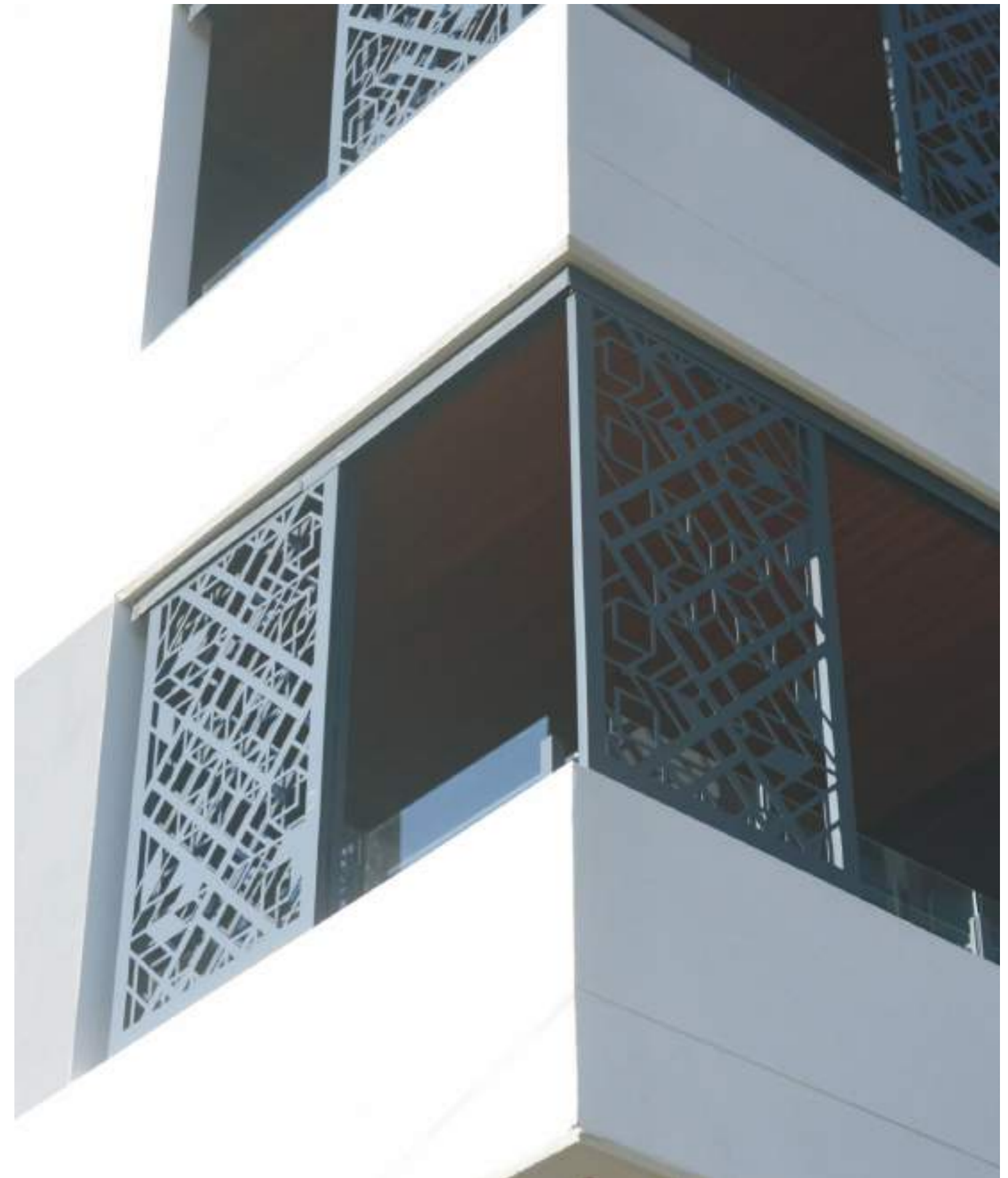
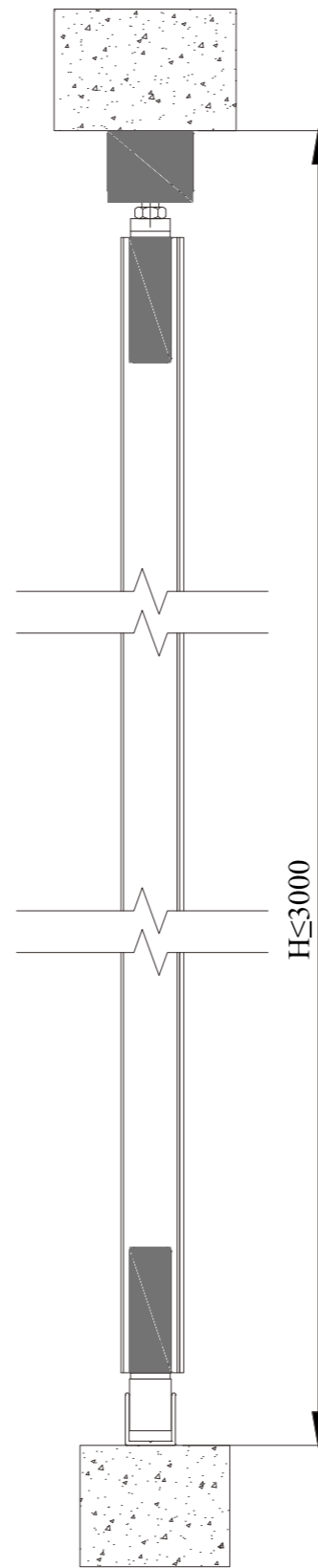

☆50x50mm as frame, aluminium perforated sheet, fit between floor and ceiling

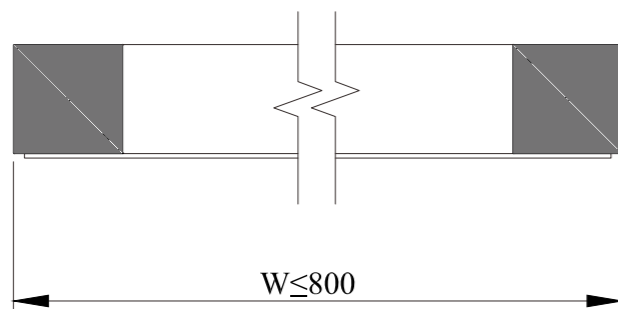
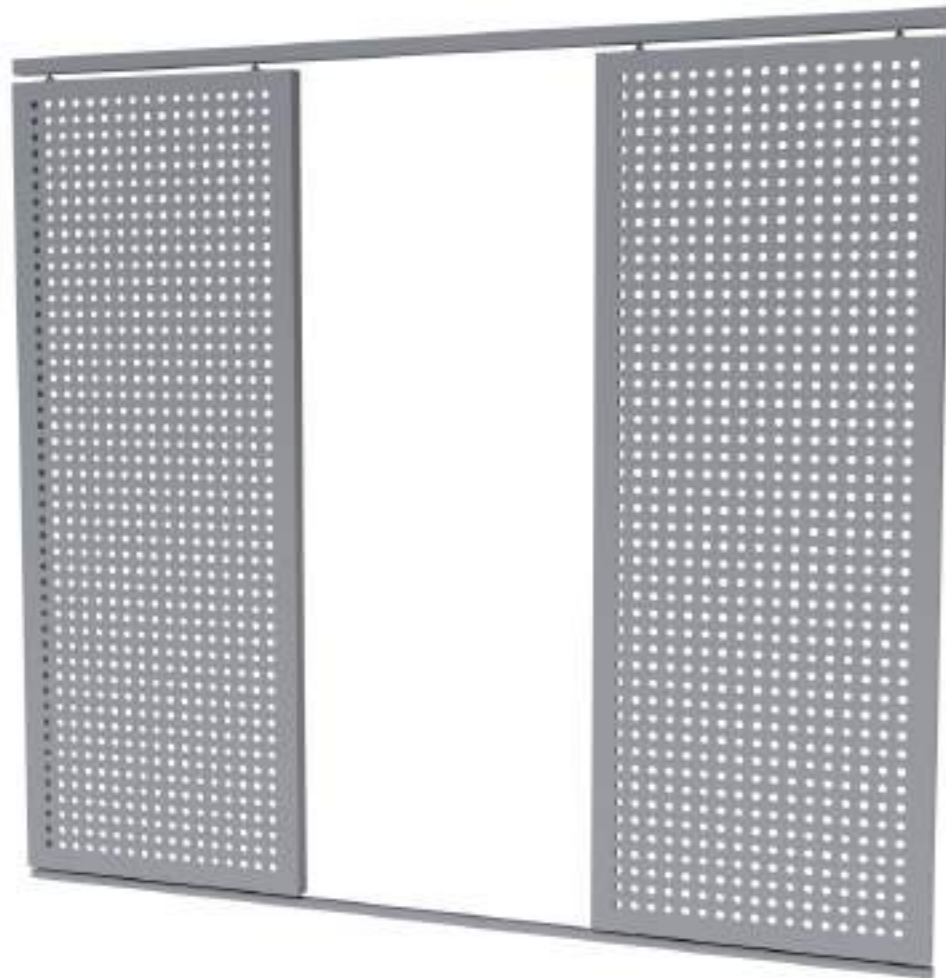

This design is assembly delivery.

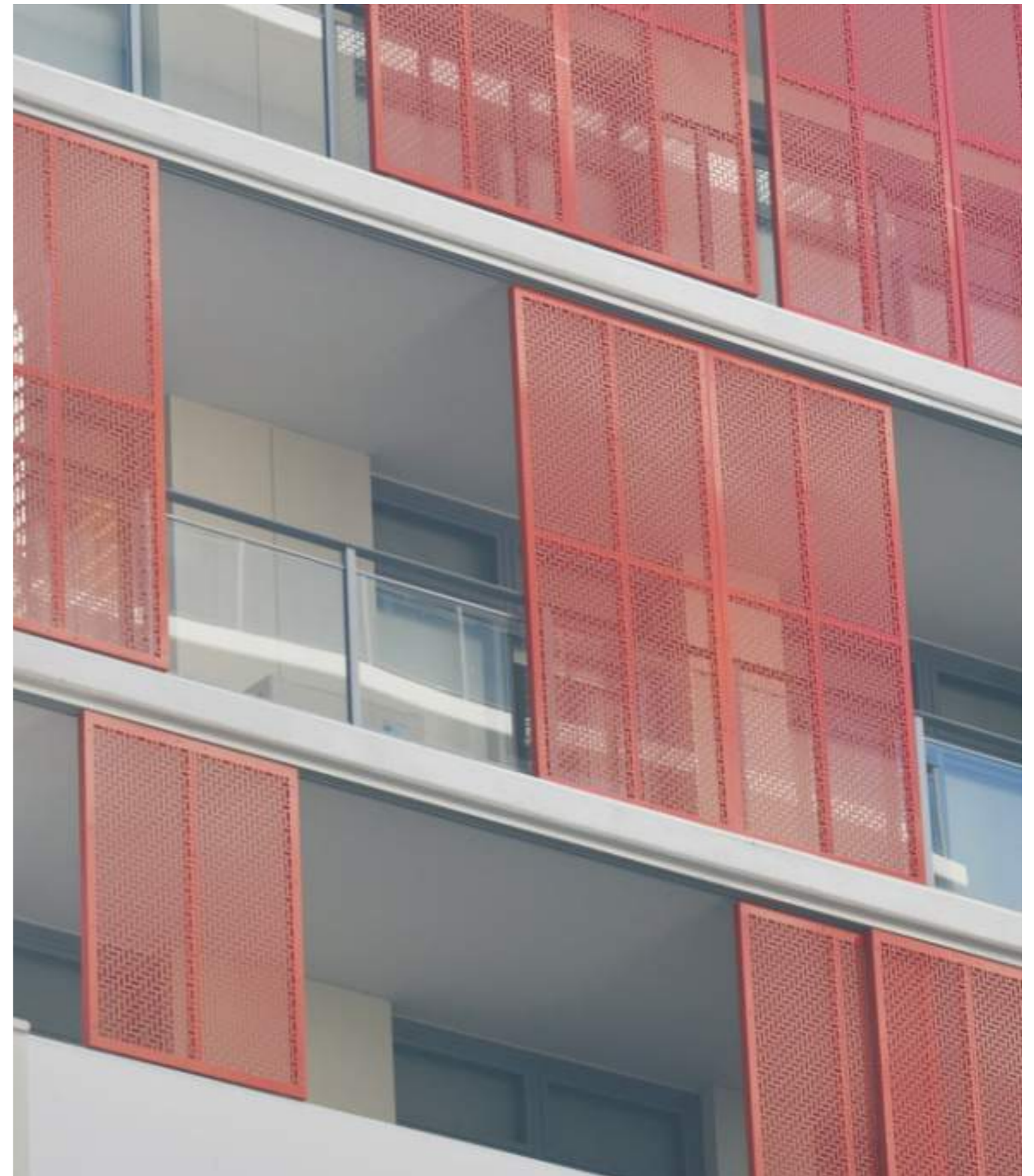
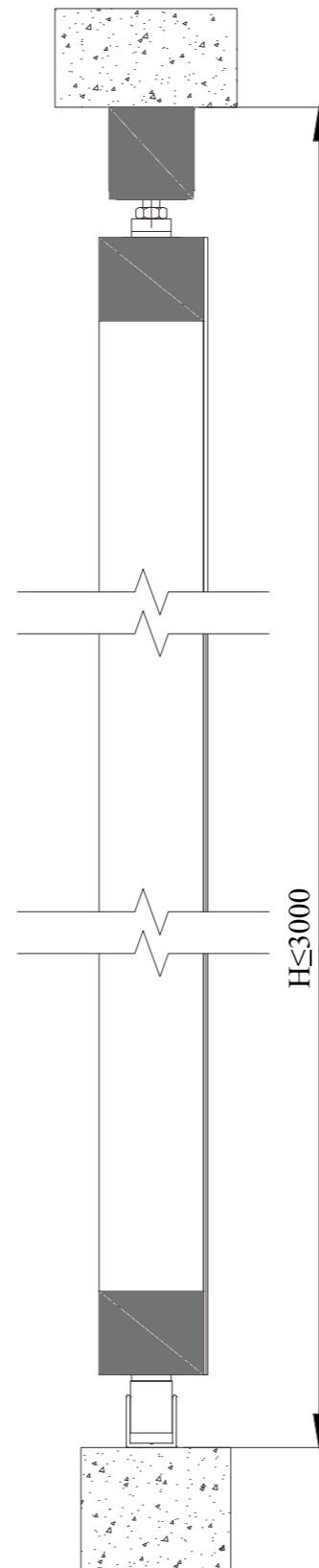

☆50x40mm as frame, frame is hidden, aluminium perforated sheet, fit between floor and ceiling

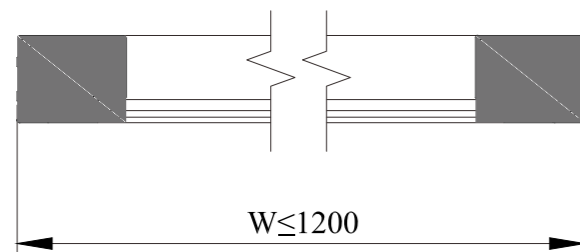
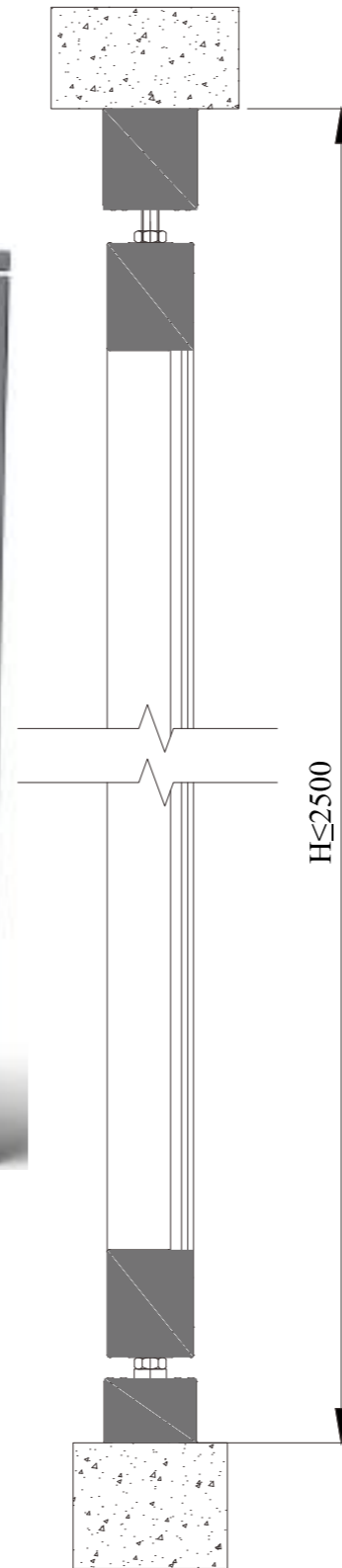
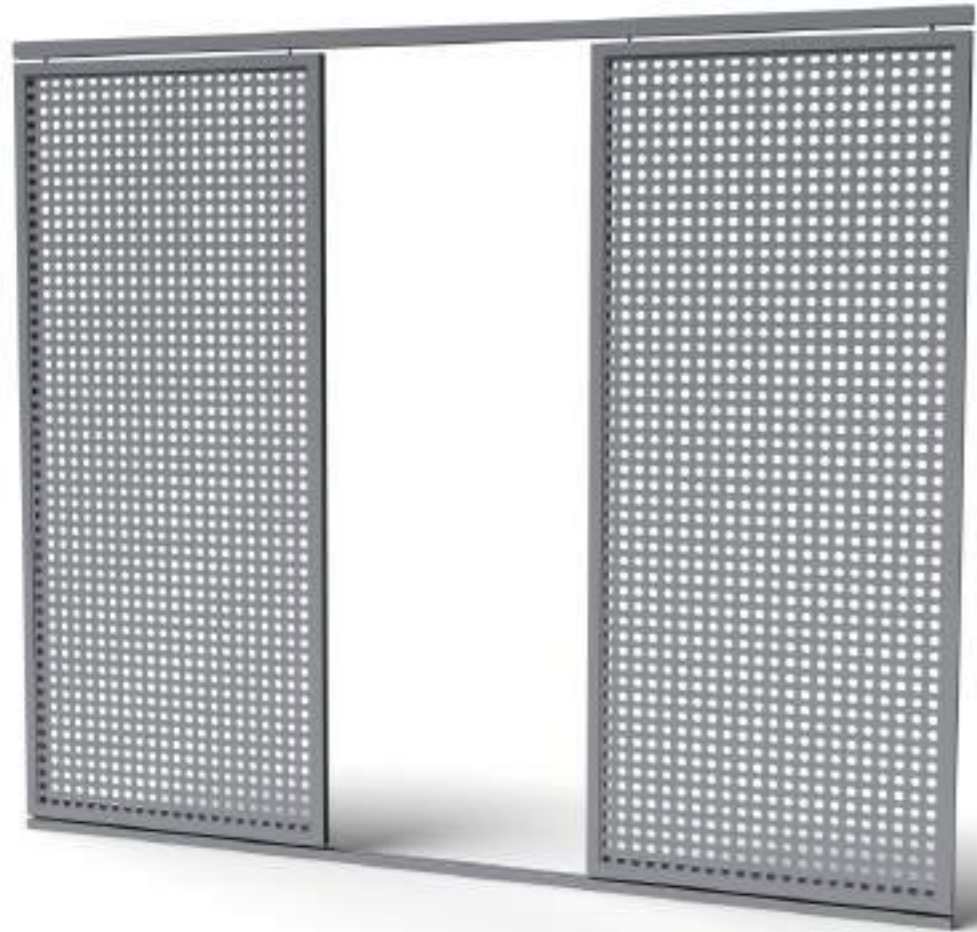

This design is assembly delivery.

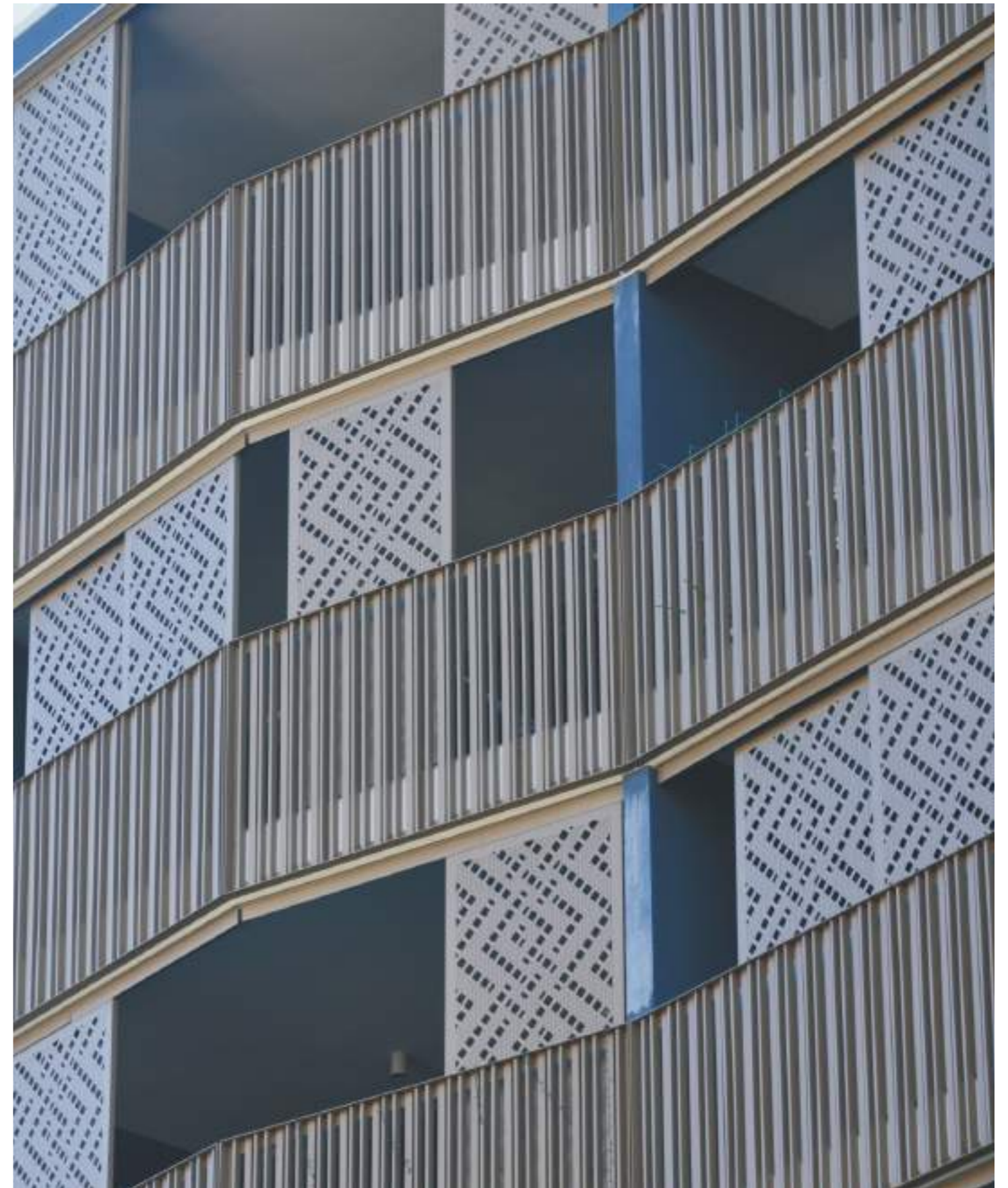

☆50x50mm as frame, fixed square blades, fit between floor and ceiling

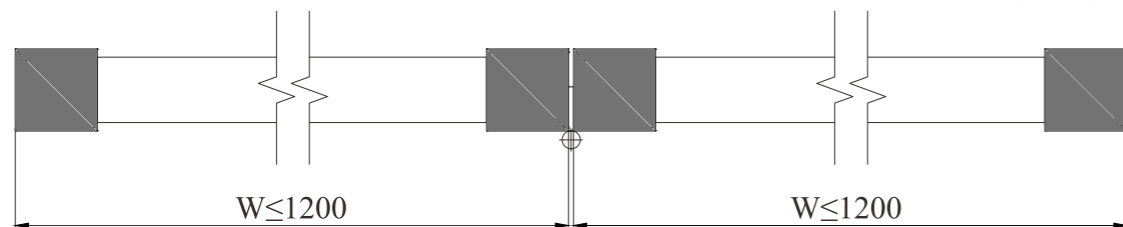

Any pitch is available.

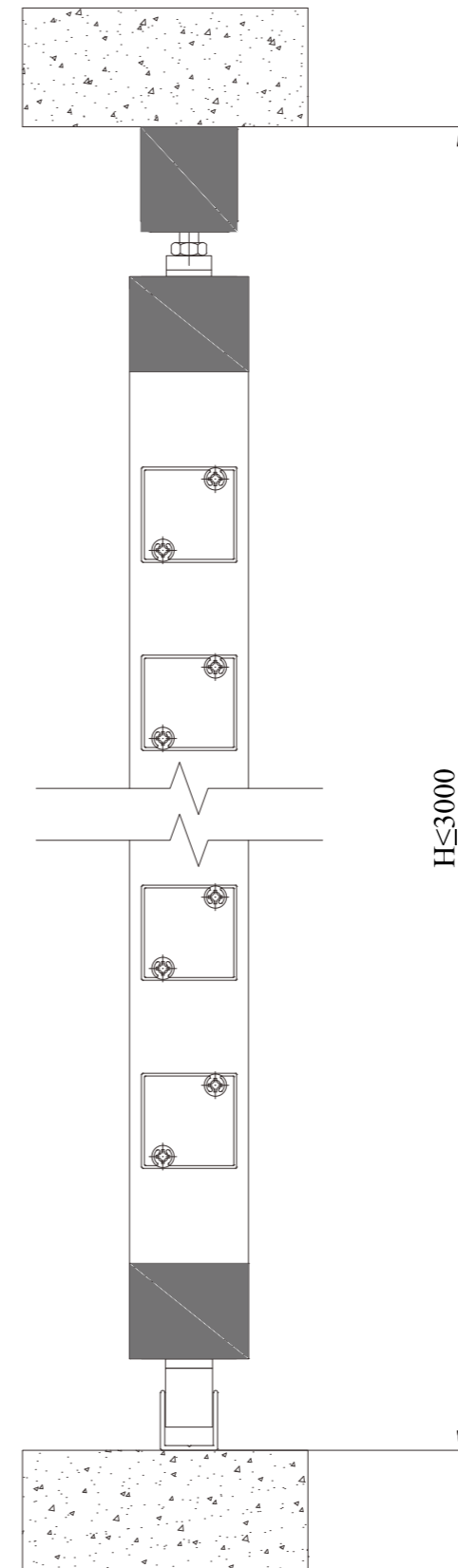
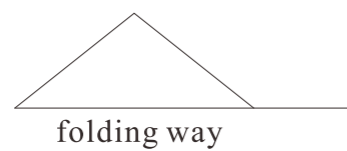

This design is assembly delivery.

Optional blades

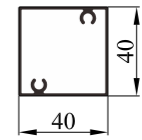

42371393

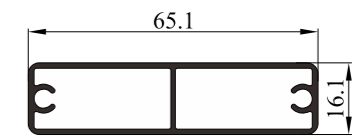

9400454

☆50x50mm as frame, fixed elliptical blades, fit between floor and ceiling

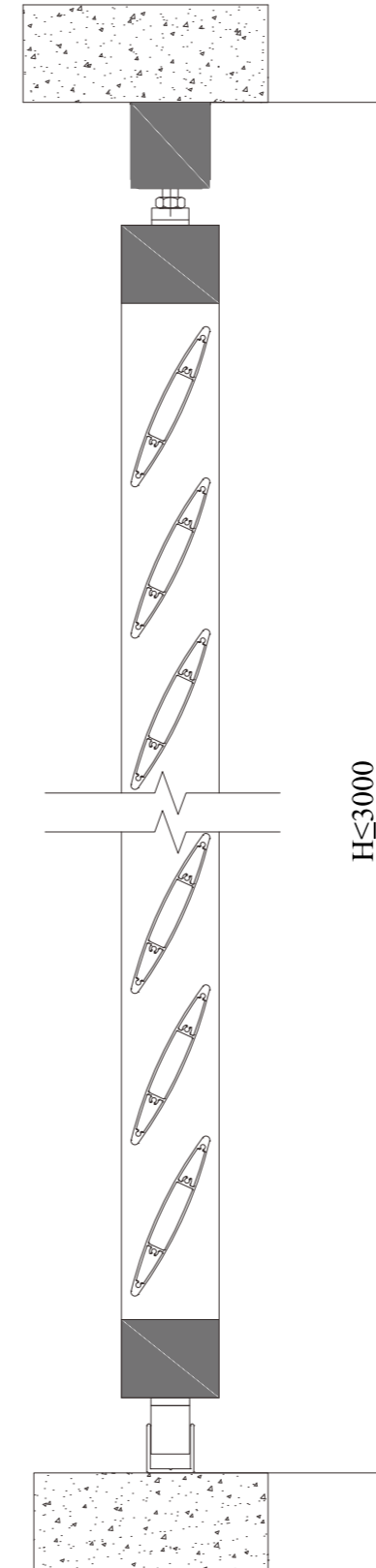
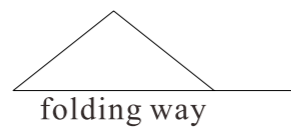
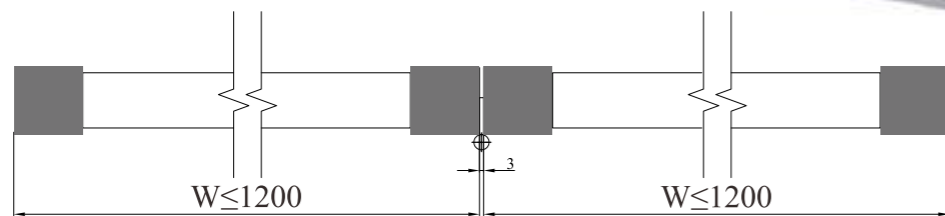

Optional blades

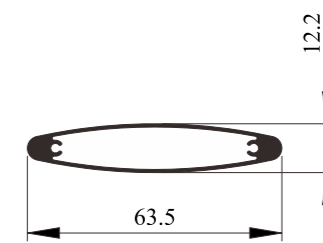

4237491

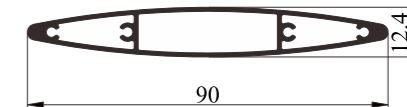

4237528

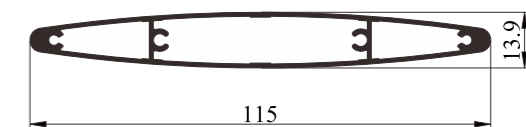

4237405

This design is assembly delivery.

☆50x50mm as frame, operable elliptical blades, fit between floor and ceiling

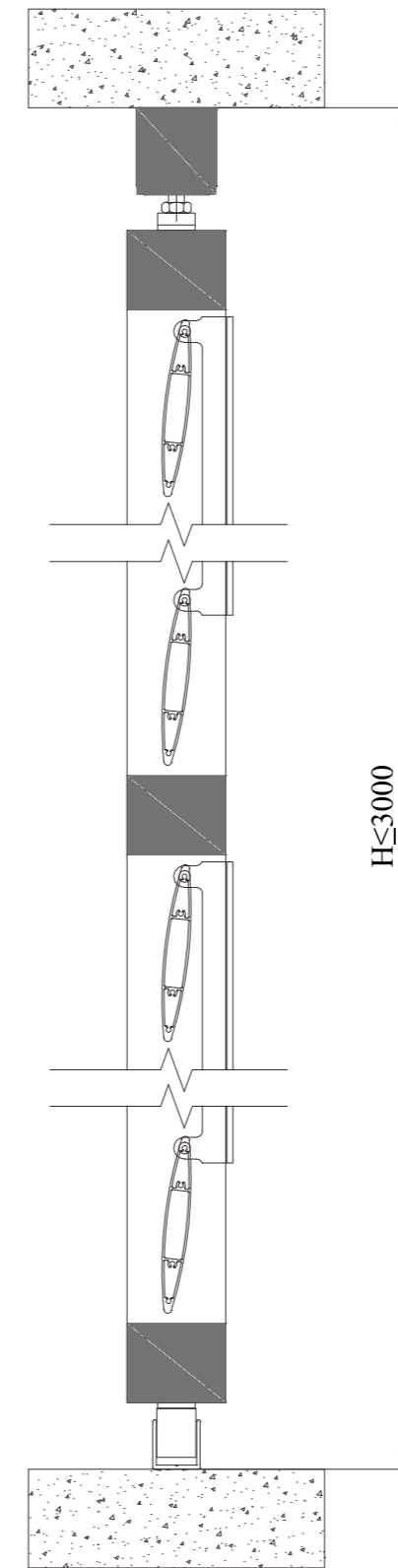
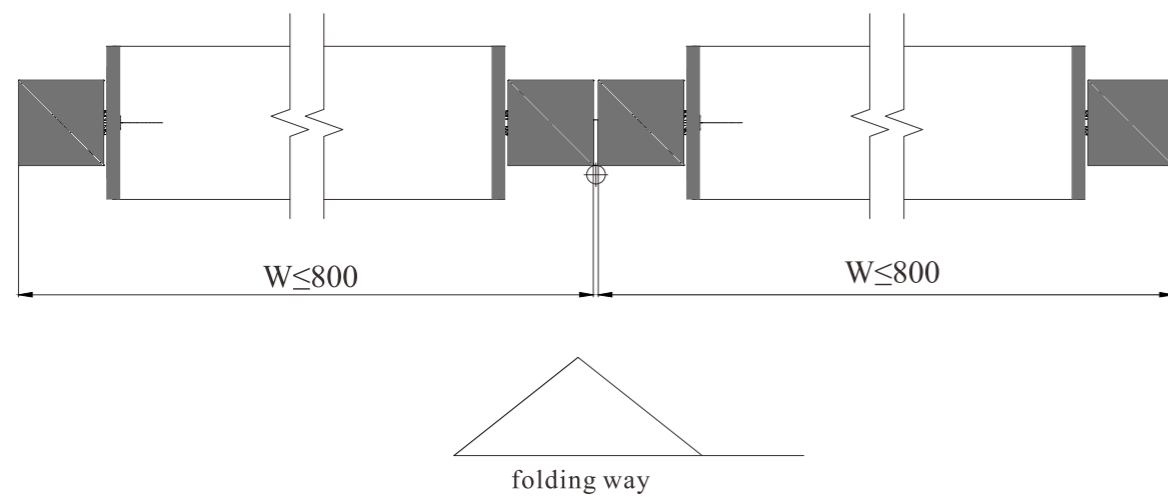

Optional blades

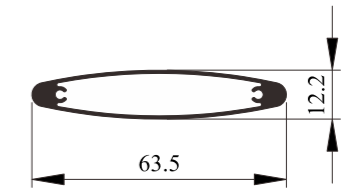

4237491

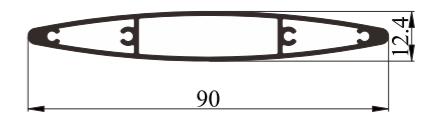

4237528

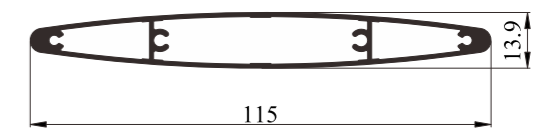

4237405

This design is assembly delivery.

☆50x36mm as frame, operable elliptical blades, fit between floor and ceiling

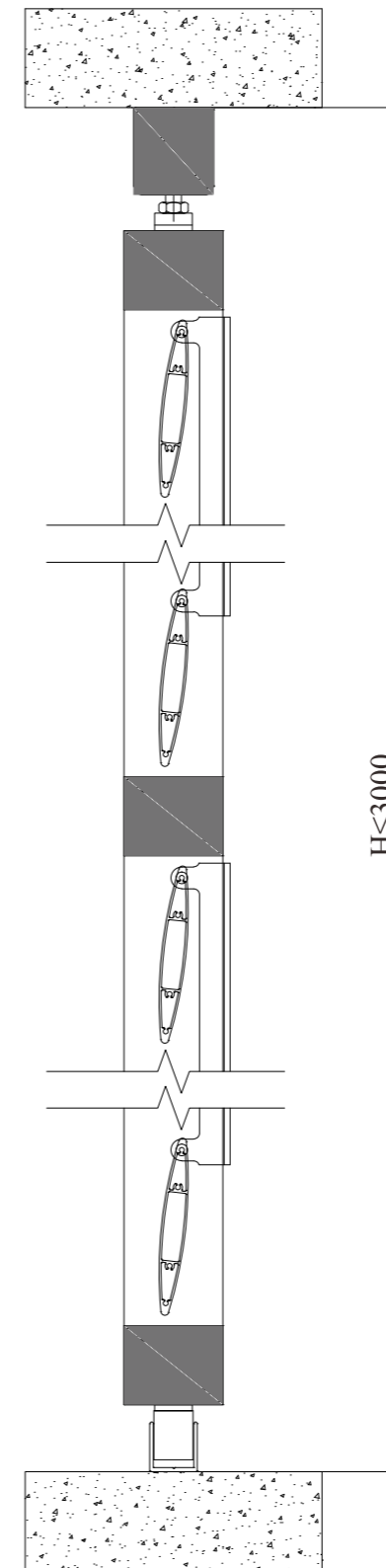
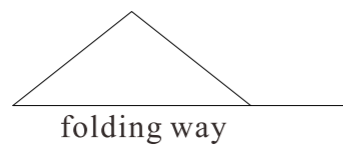
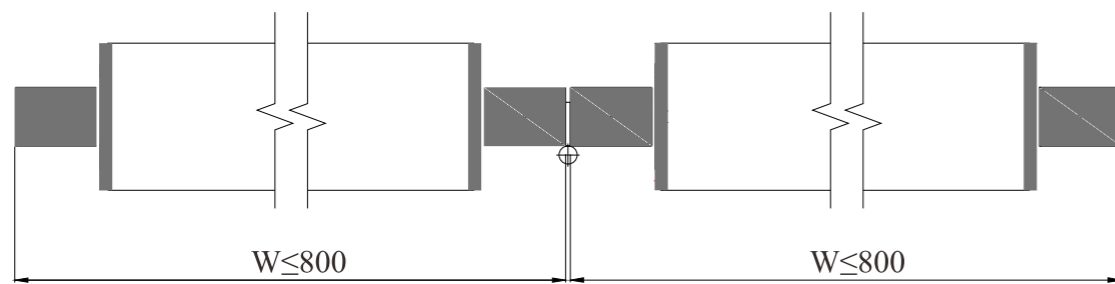

This design is assembly delivery.

Optional blades

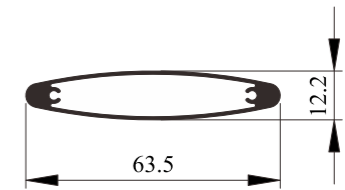

4237491

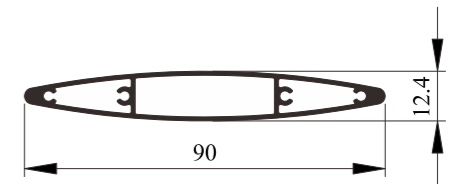

4237528

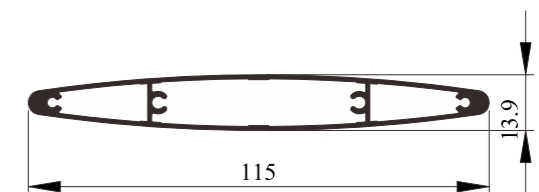

4237405





☆60x28mm as frame, aluminium perforated sheet, fit between floor and ceiling

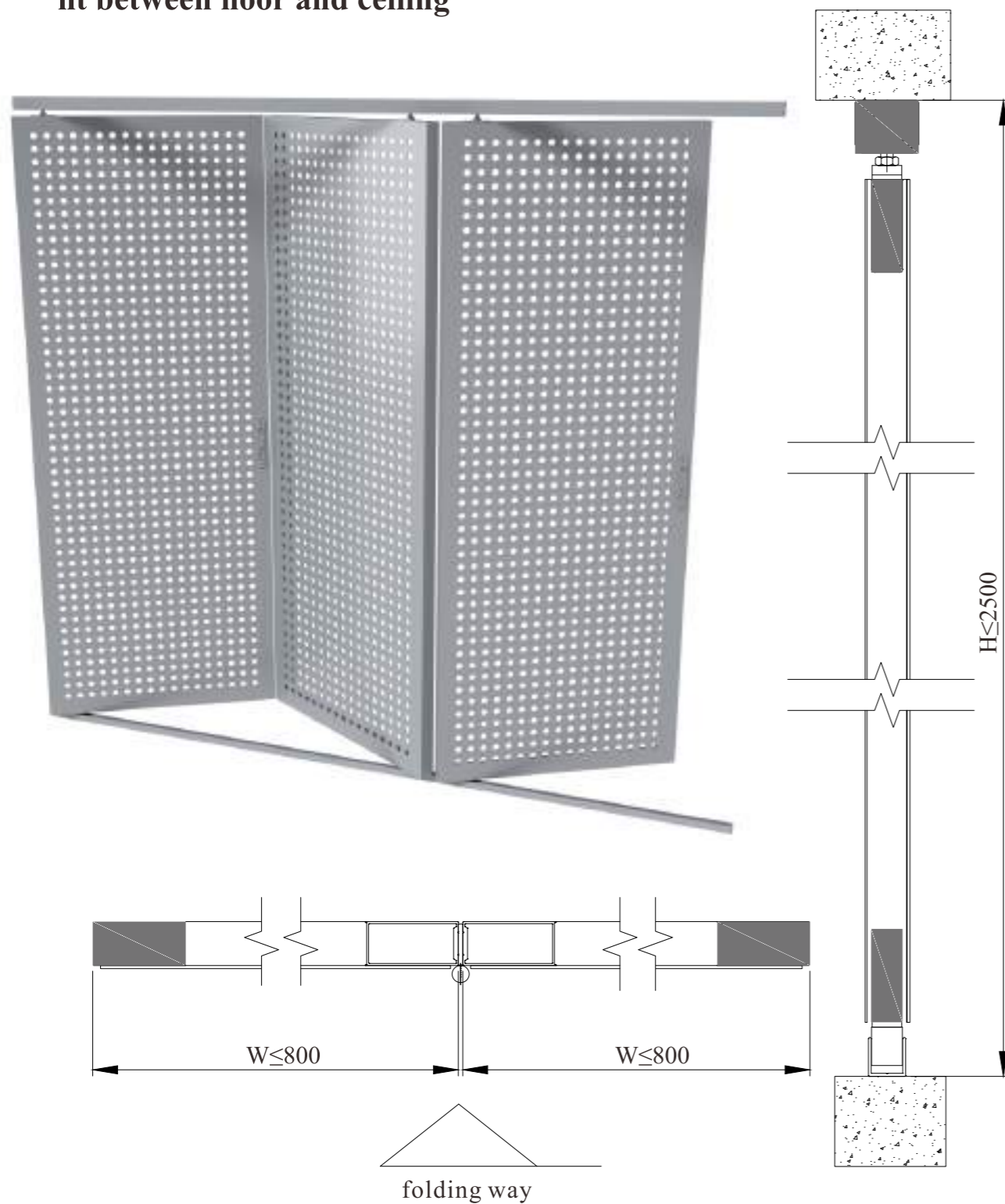

This design is assembly delivery.

☆50x50mm as frame, aluminium perforated sheet, fit between floor and ceiling

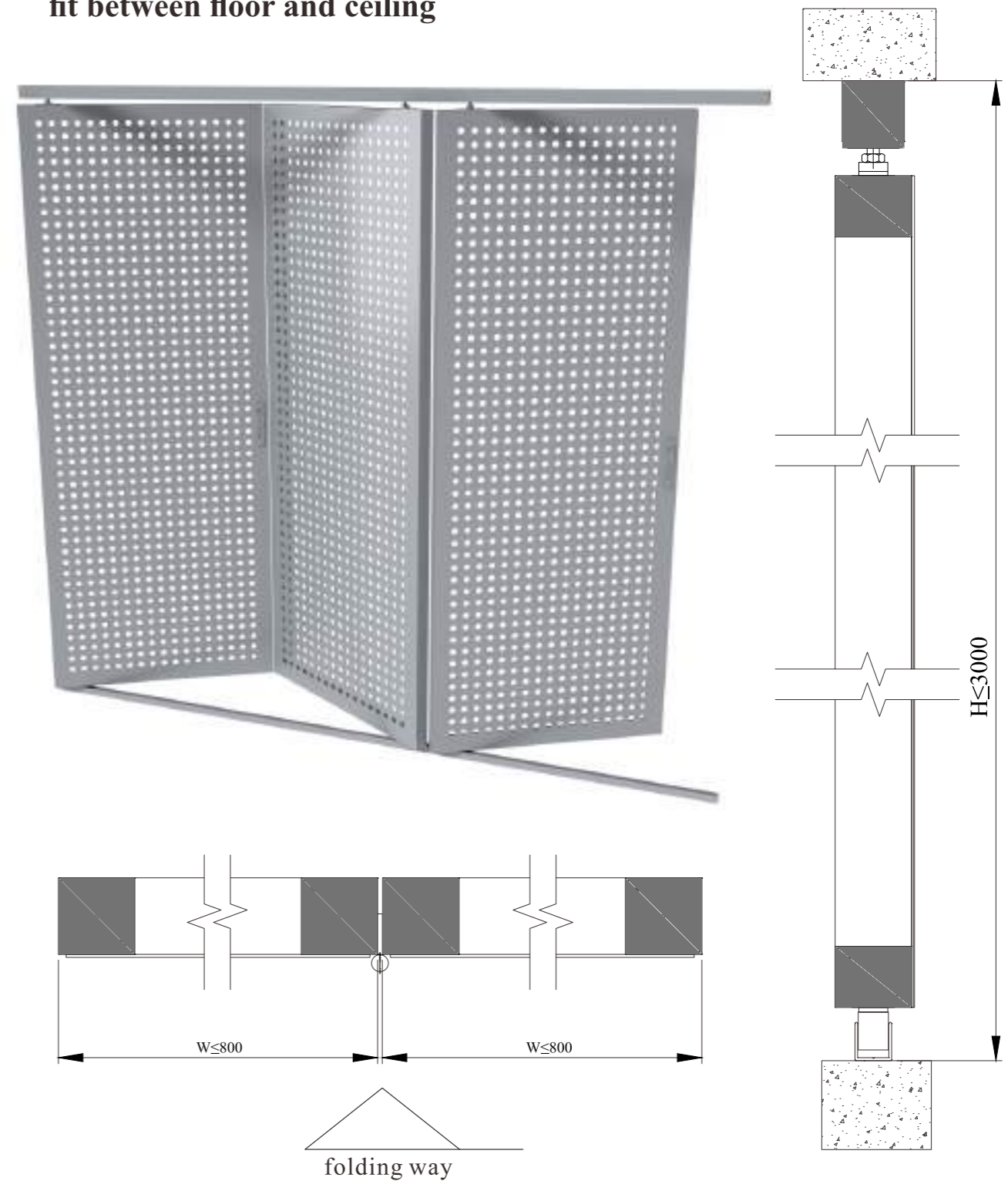

This design is assembly delivery.

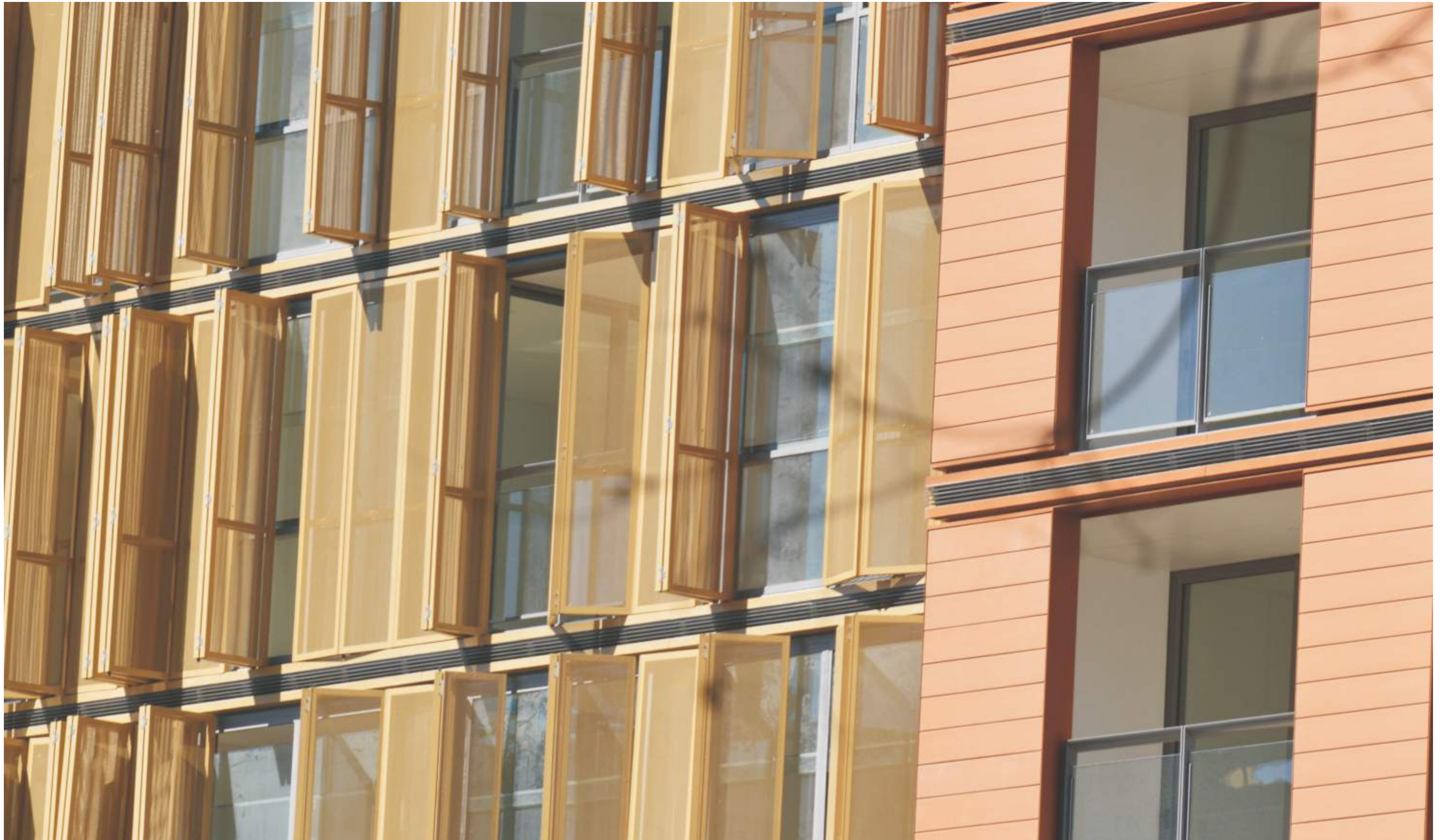

☆50x40mm as frame, frame is hidden, aluminium perforated sheet, fit between floor and ceiling

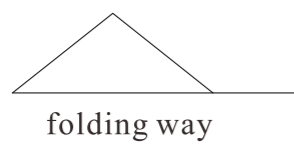
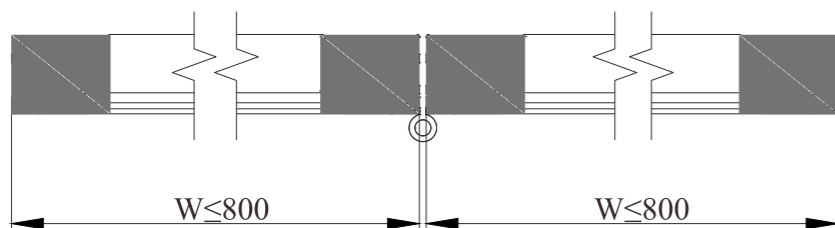
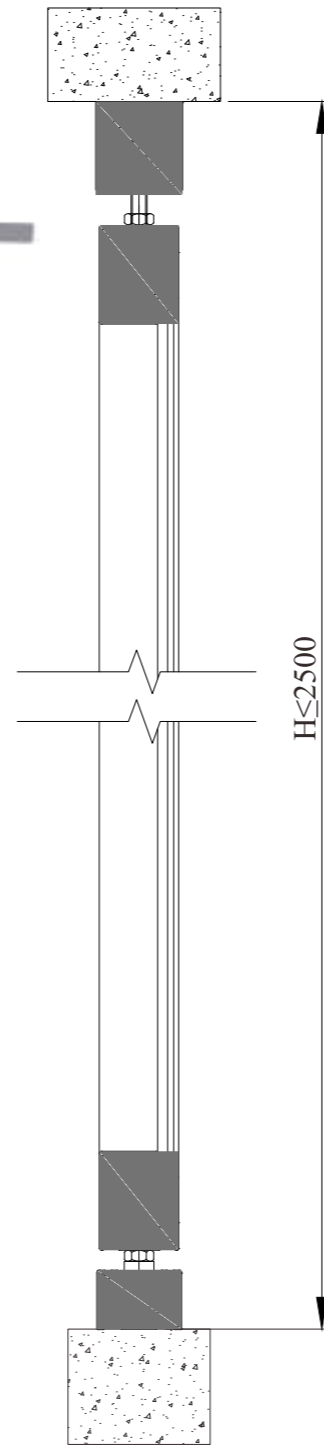
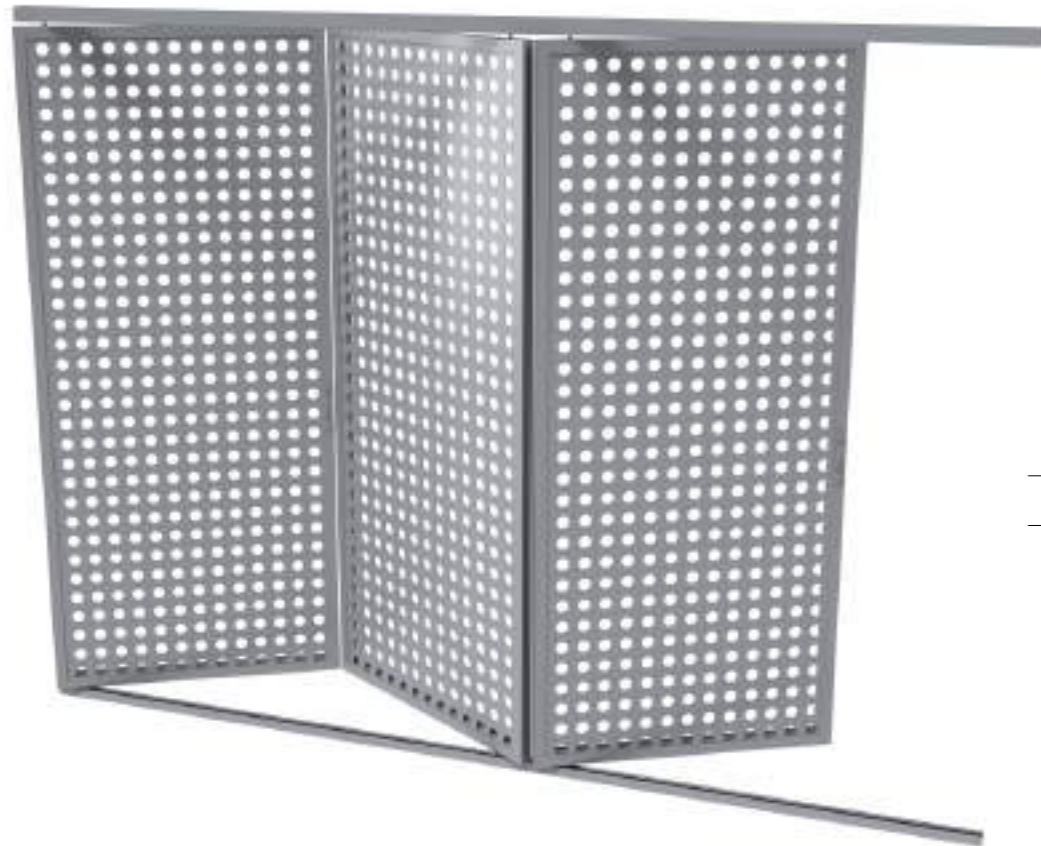

This design is assembly delivery.



☆ Square blades, vertical assembly, face fit on walls

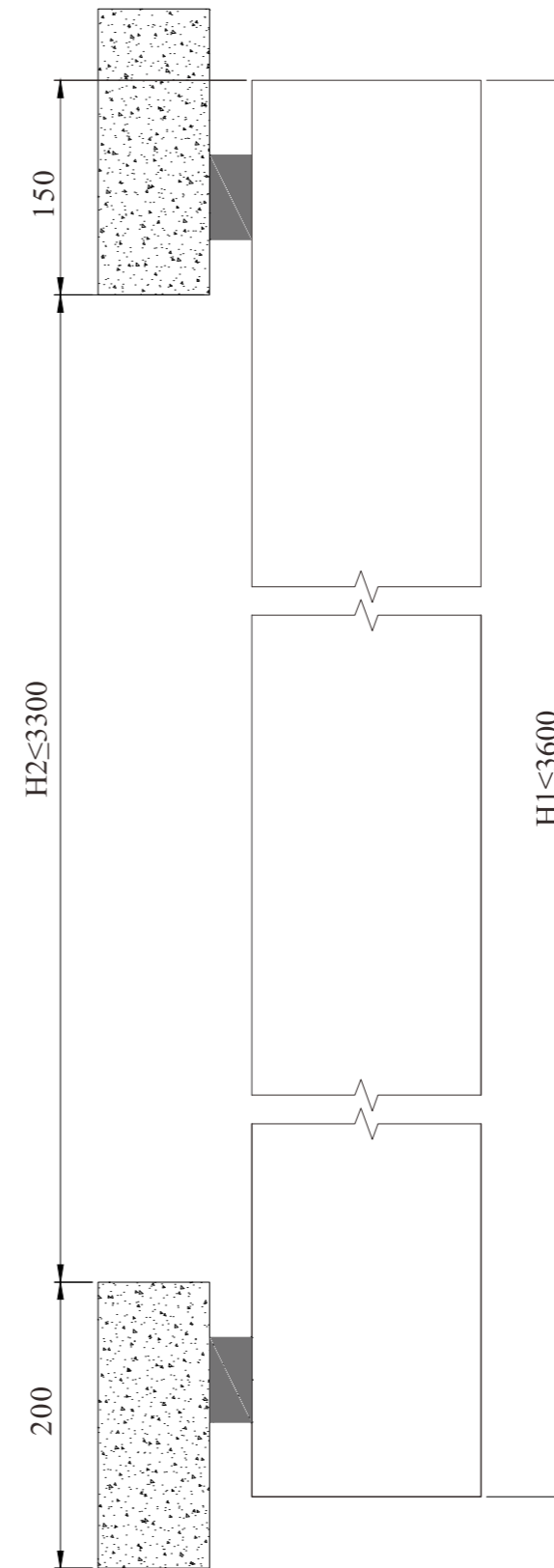
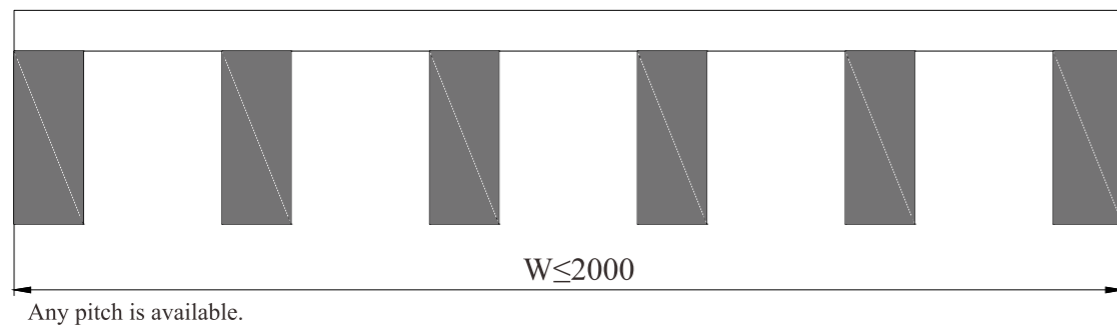

Optional blades

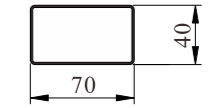

9400482

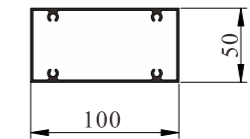

42371368

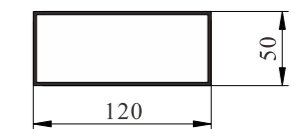

9400260

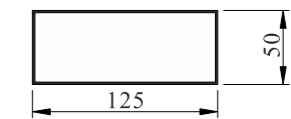

9400533

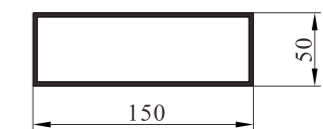

9400523

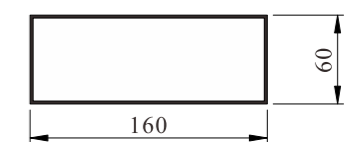

9400382

This design can be kits loose pack delivery or assembly delivery.



☆ Elliptical blades, horizontal assembly, over-hang on walls

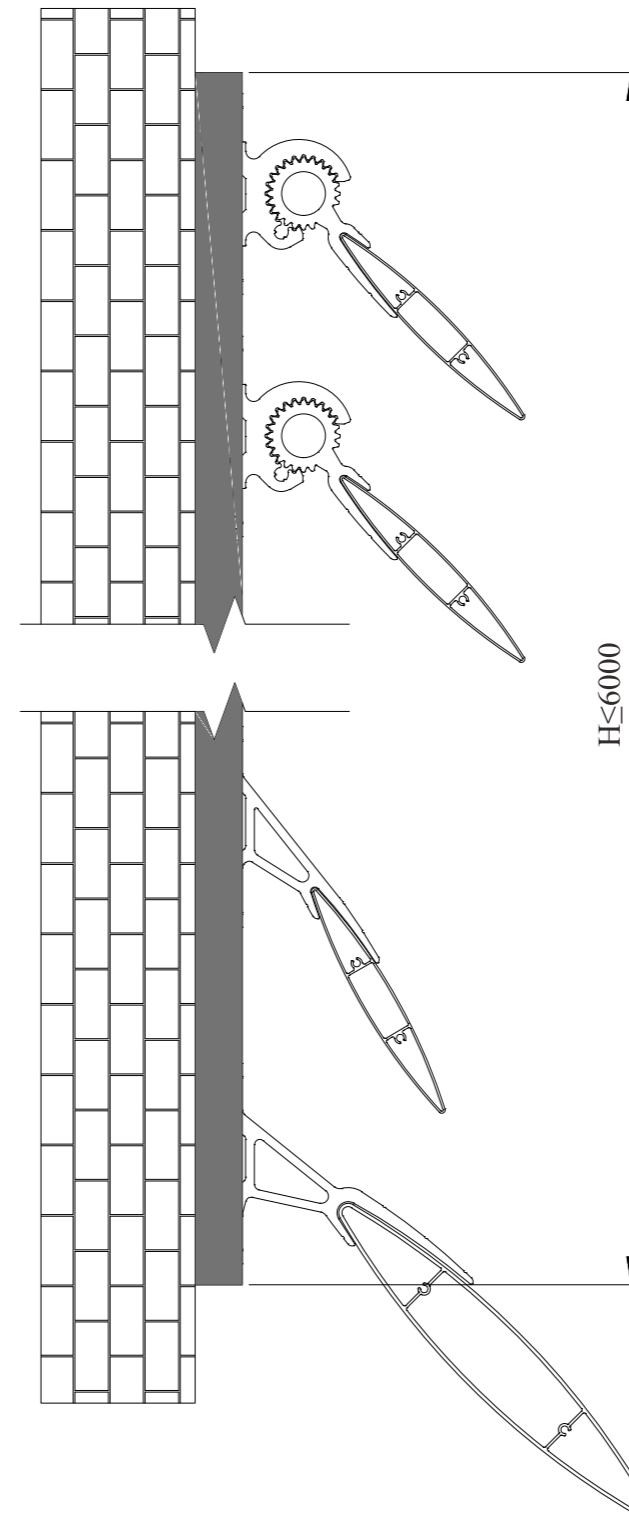
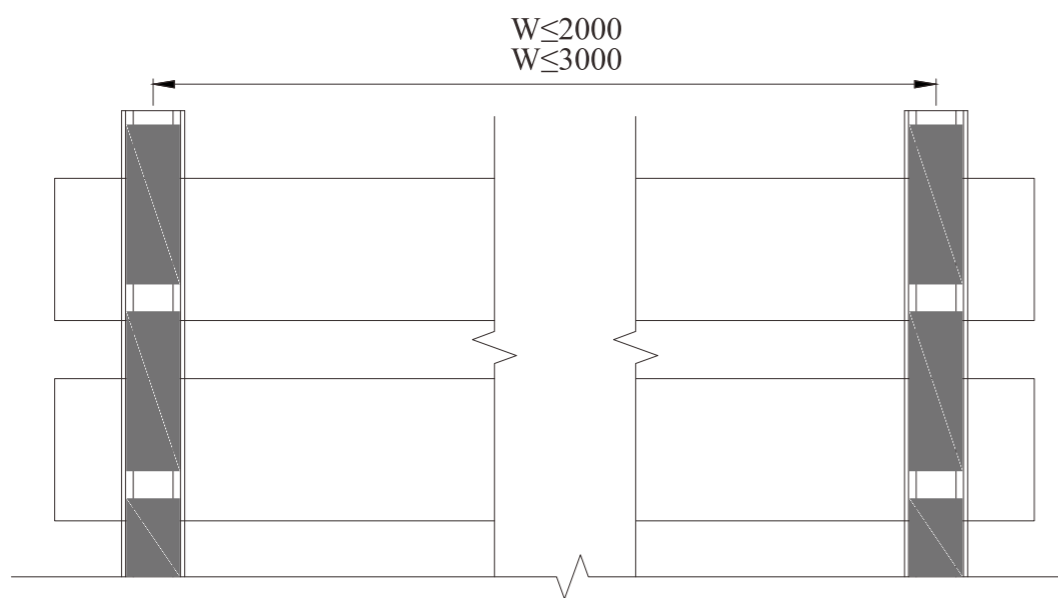
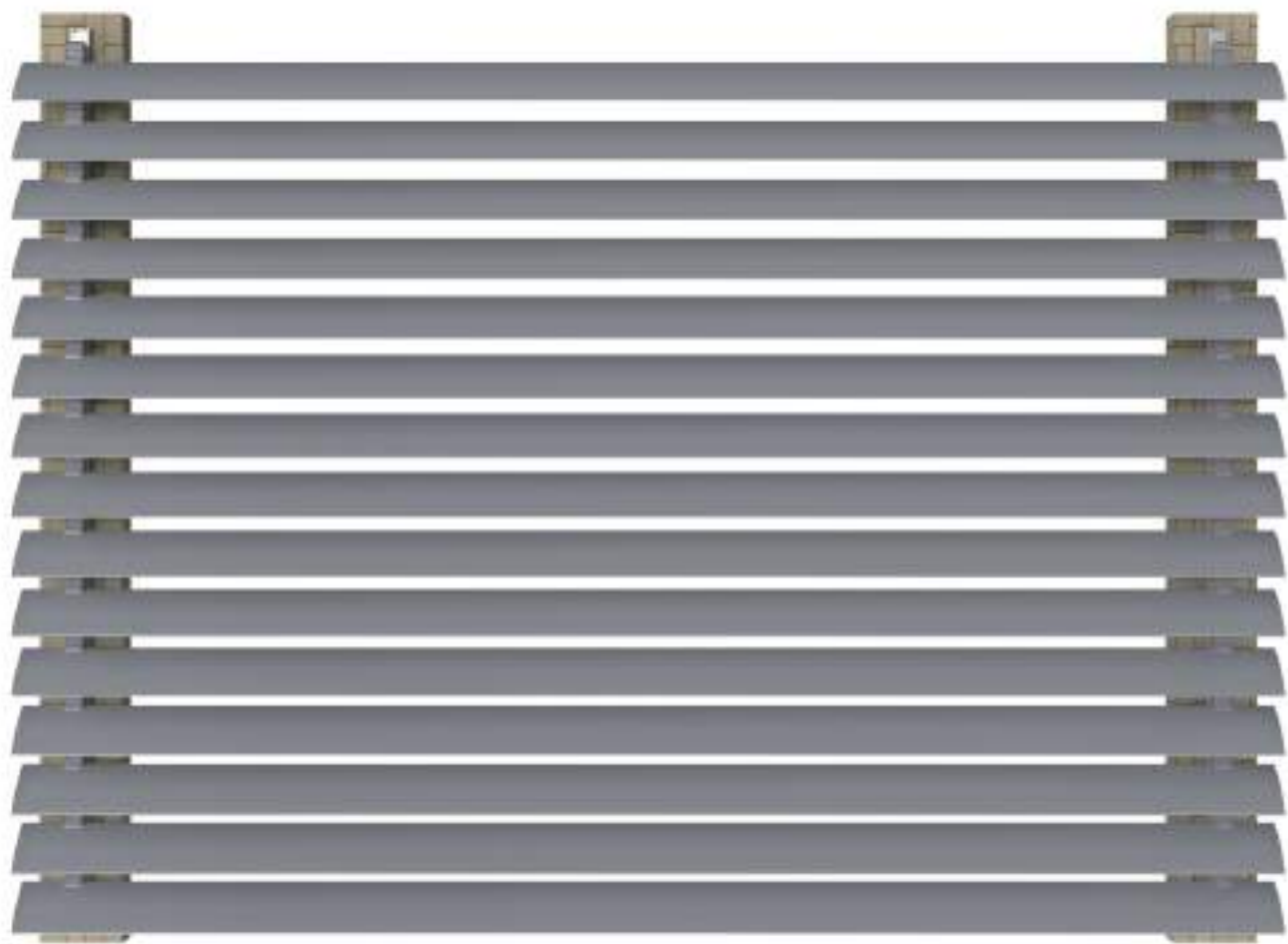

This design is kits loose pack delivery.

Optional blades

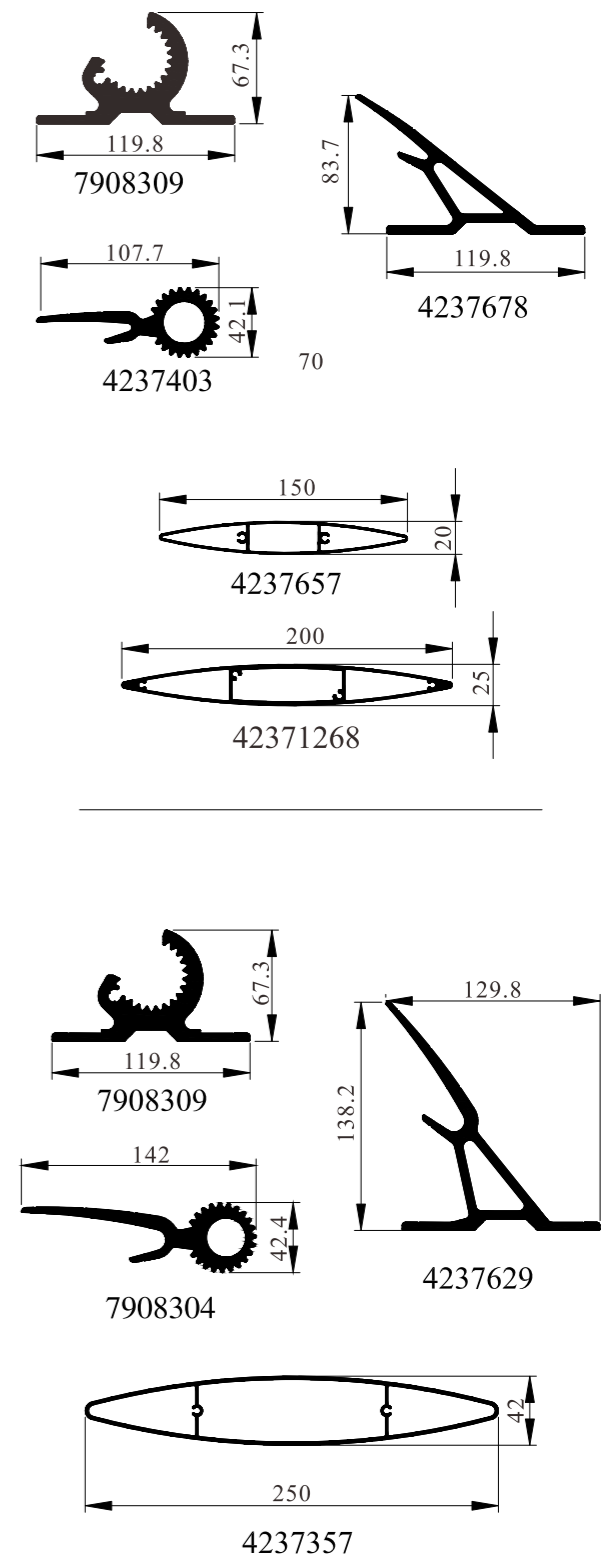

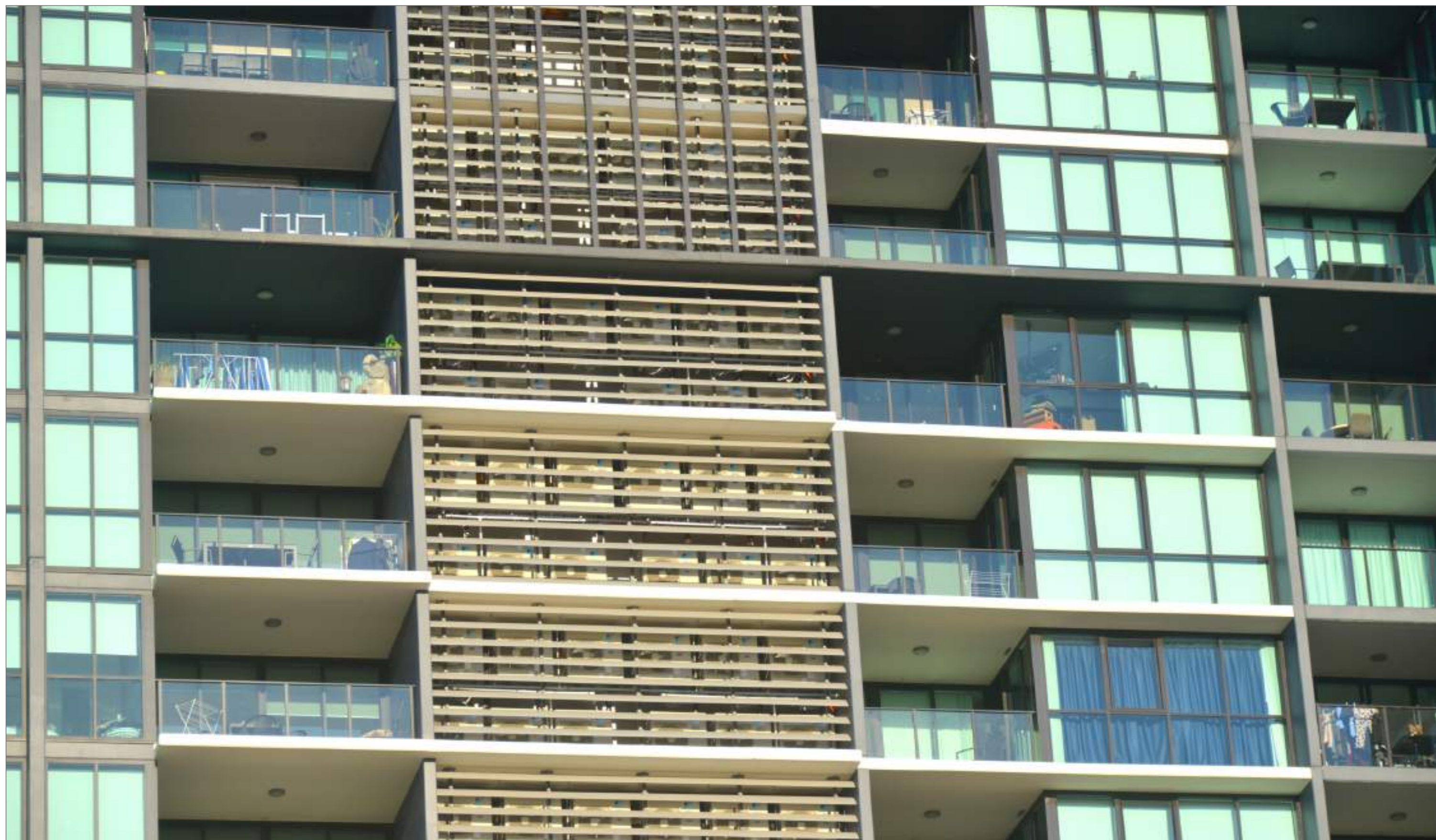

☆ Elliptical blades, vertical assembly, over-hang on walls

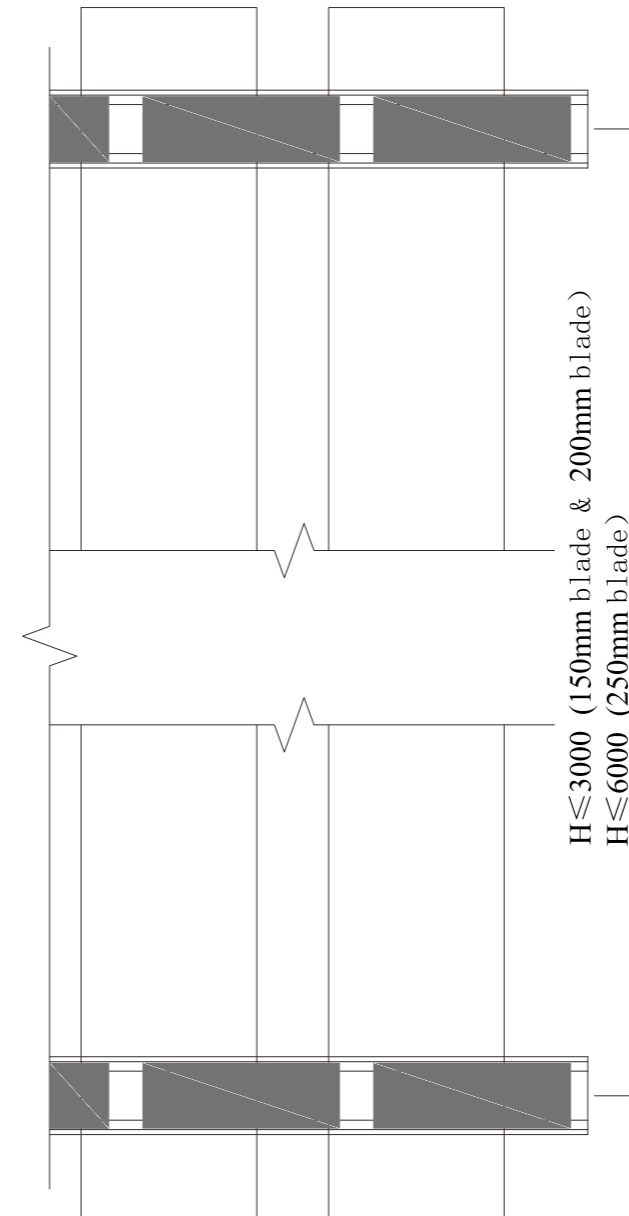
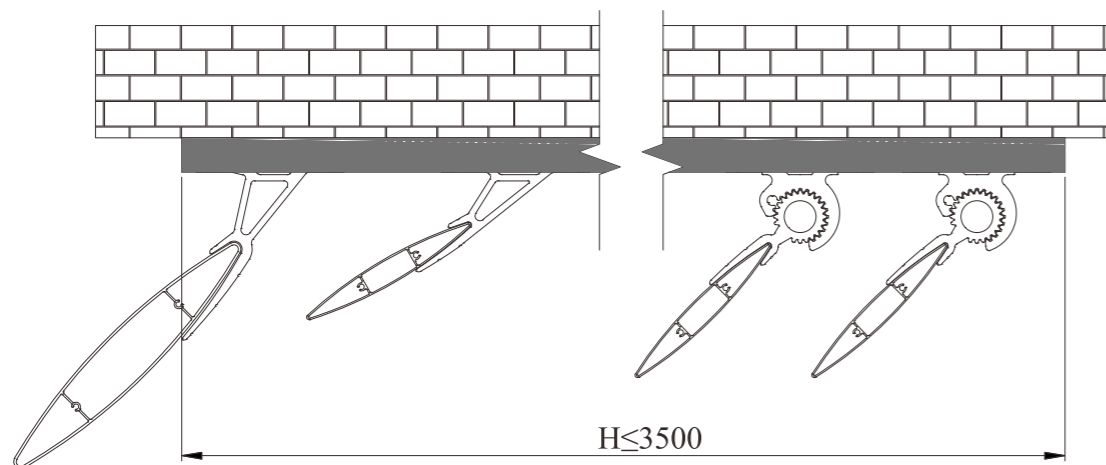
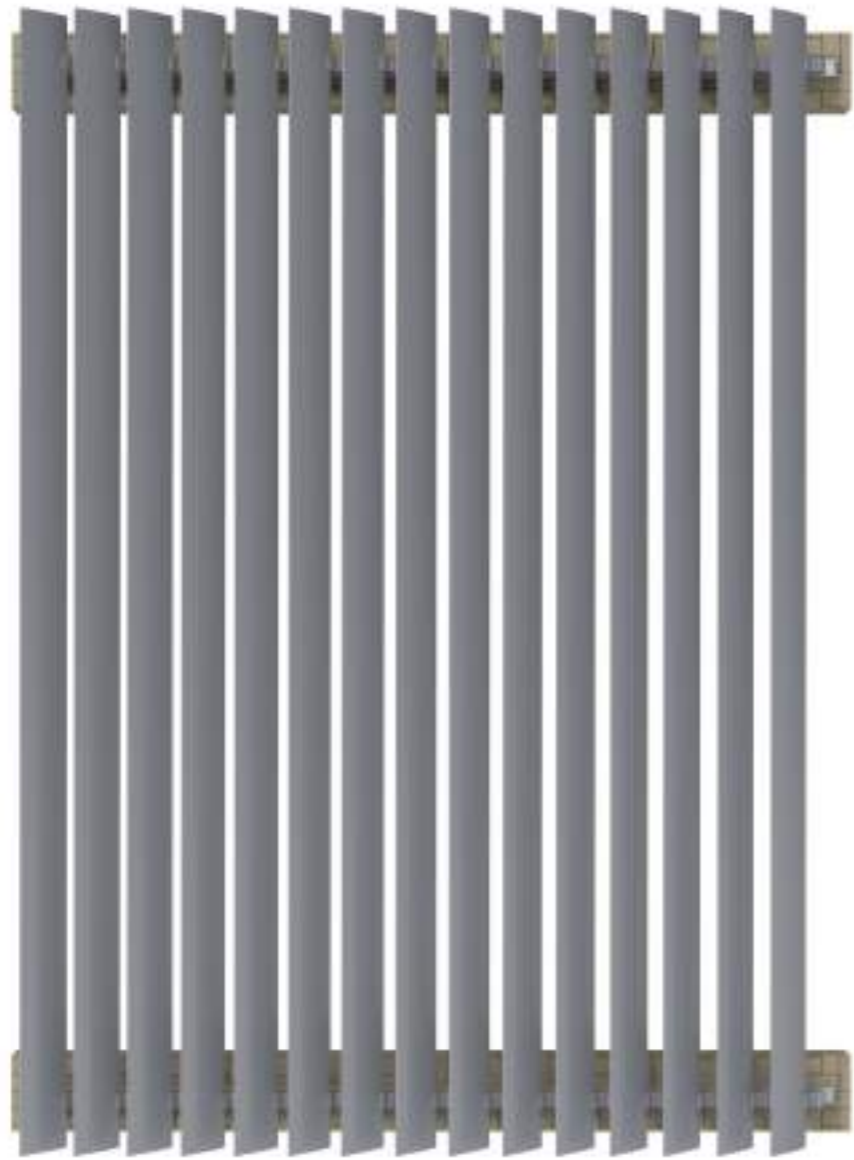

This design is kits loose pack delivery.

Optional blades

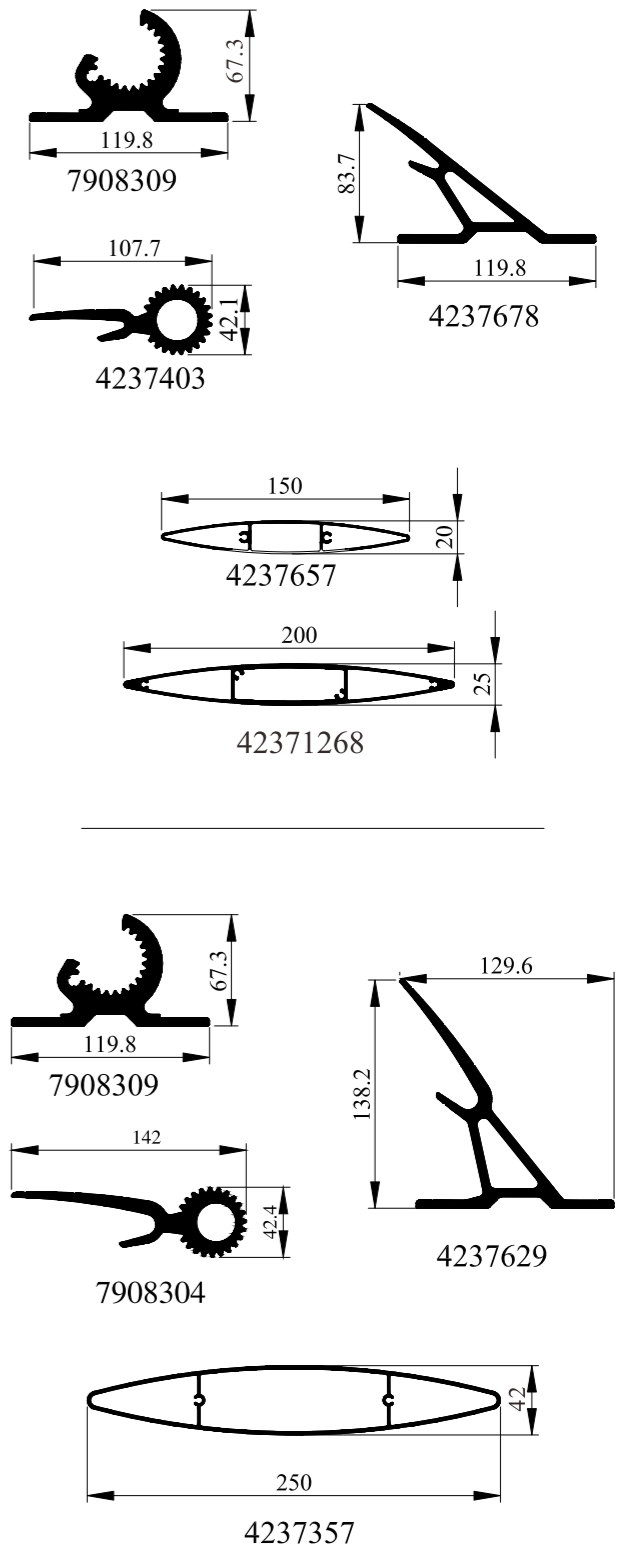



☆ Elliptical blades, vertical assembly, fit between floor and ceiling

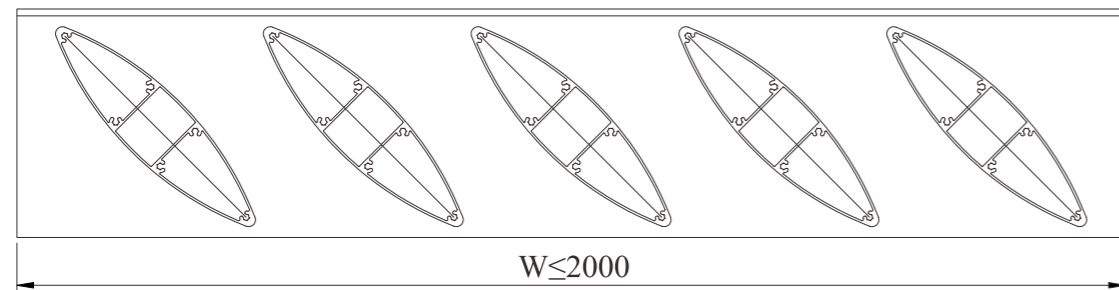
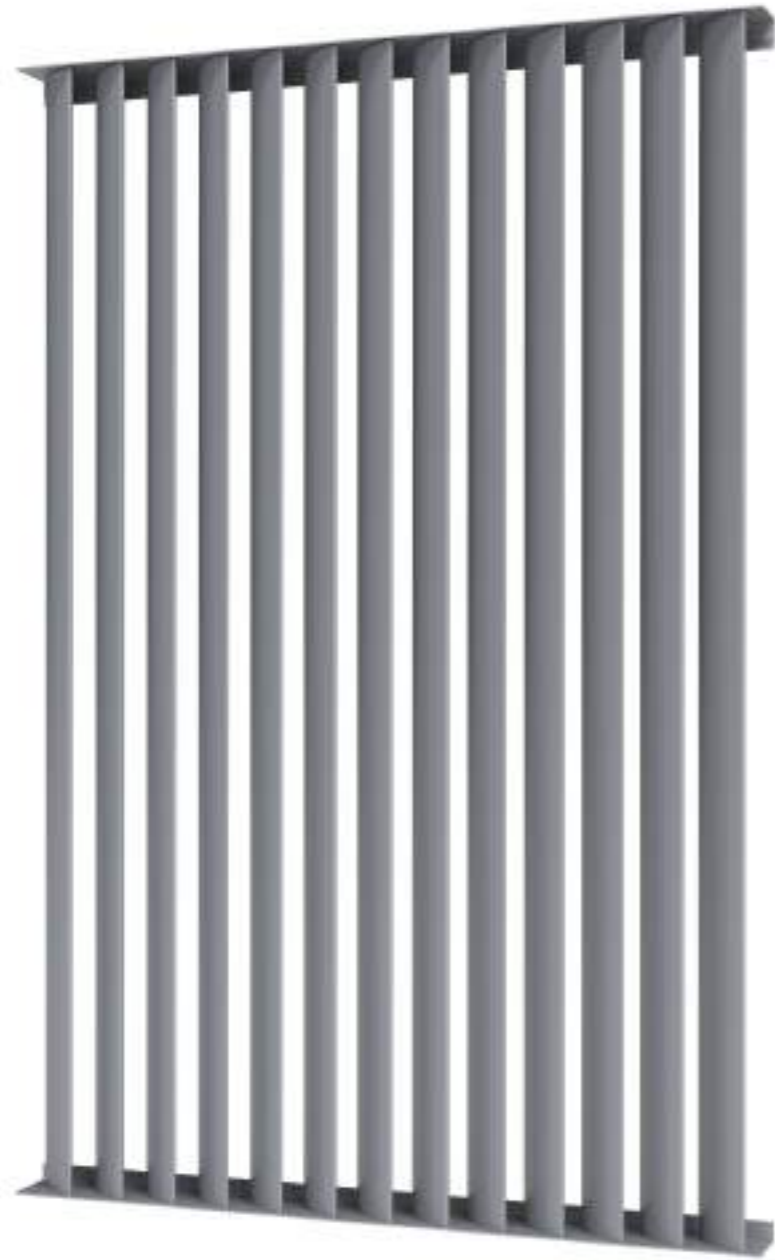

Any pitch is available.

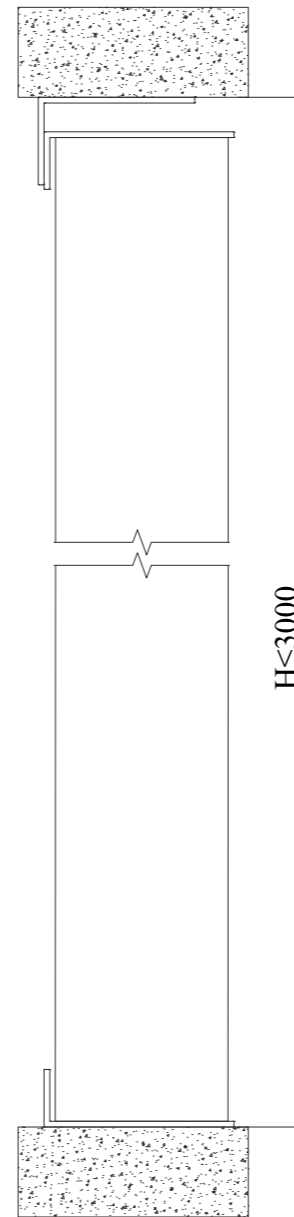

Optional blades

42371030	9300367
4237357	9300367
42371286	9300367
42371238	9300367
42371268	9300367
4237976	9300367
4237353	9300376
42371115	9300376
42371165	9300359

This design can be kits loose pack delivery or assembly delivery.

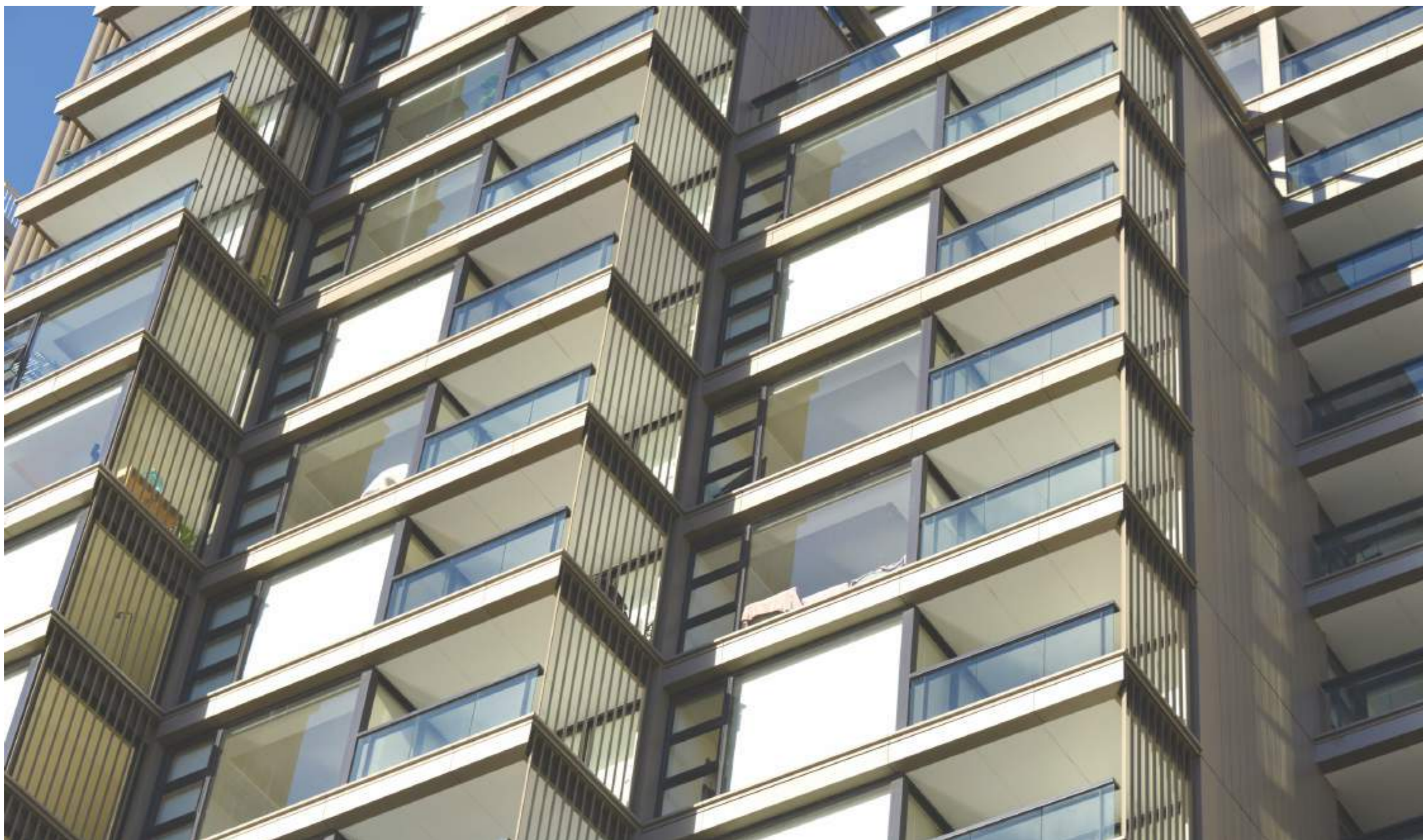

☆ Square blades, 90 degree vertical assembly, fit between floor and ceiling

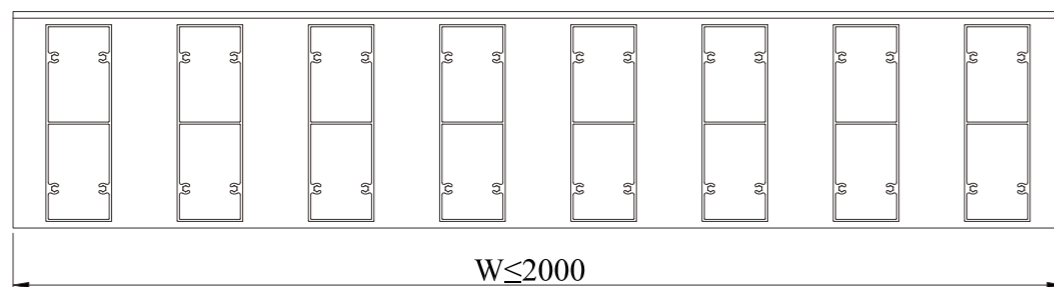
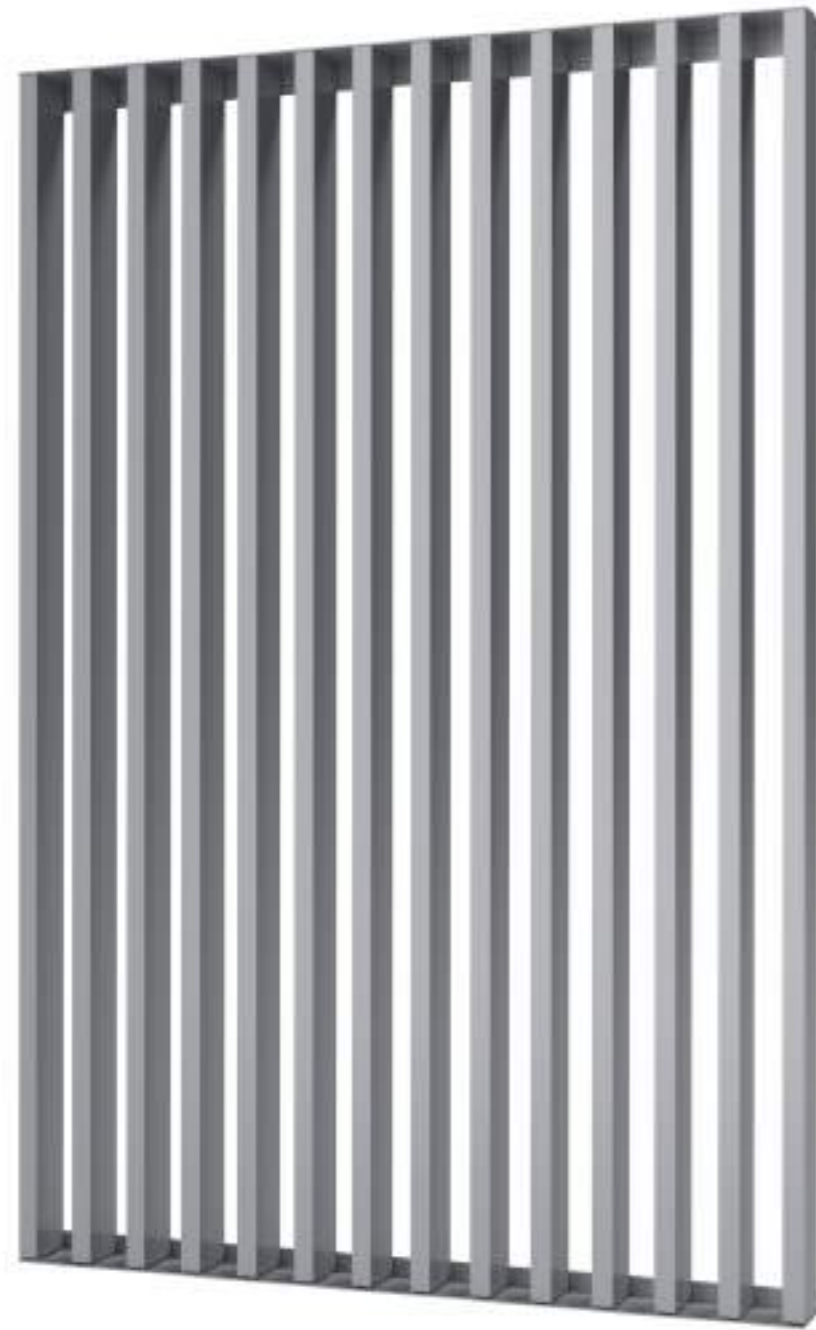

Any pitch is available.

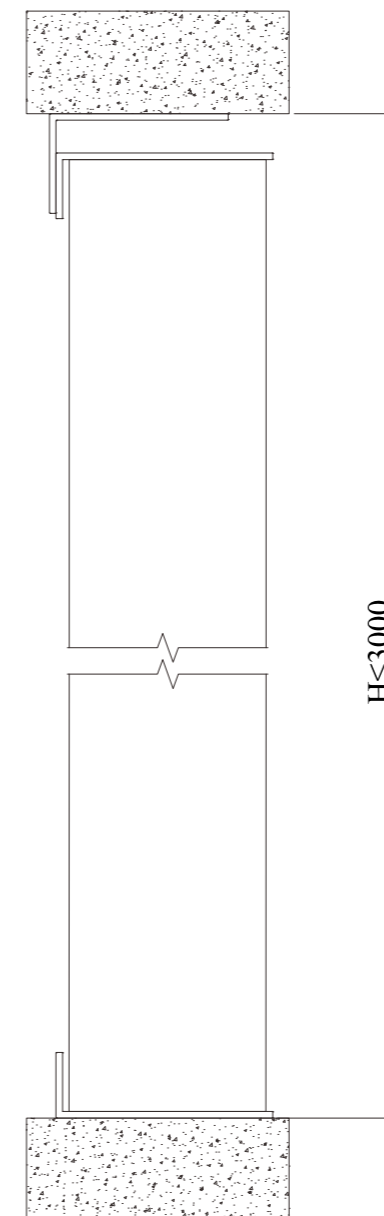

Optional blades

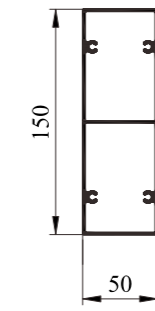

42371321

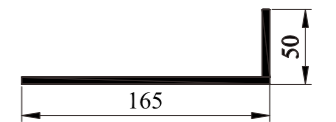

9300367

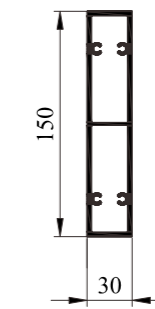

42371176

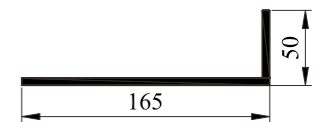

9300367

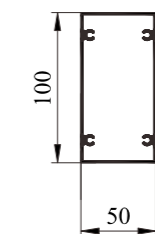

42371368

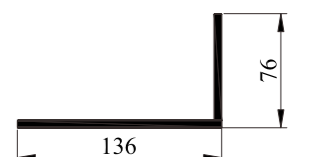

9300376

This design can be kits loose pack delivery or assembly delivery.

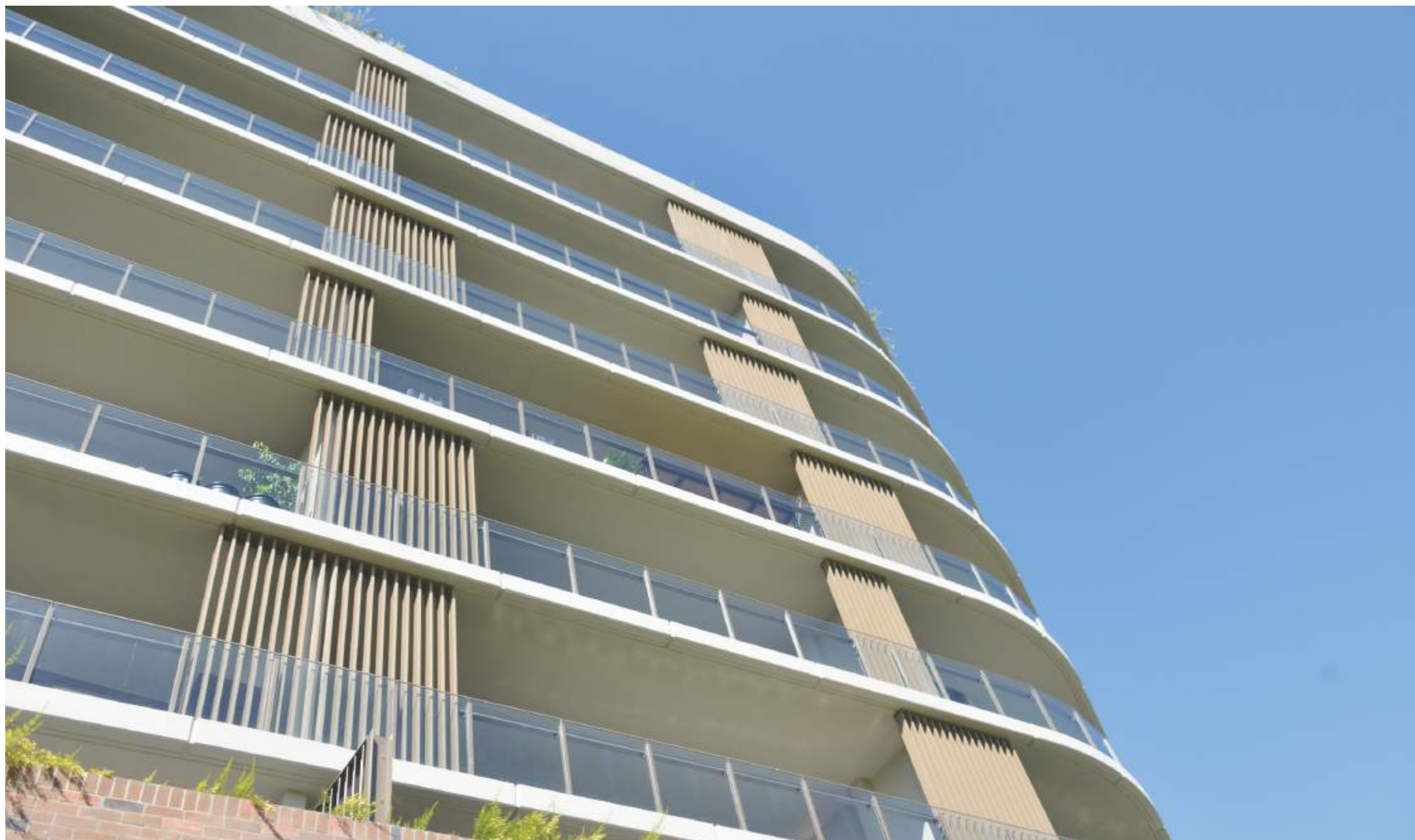

☆ Square blades, various degree vertical assembly, fit between floor and ceiling

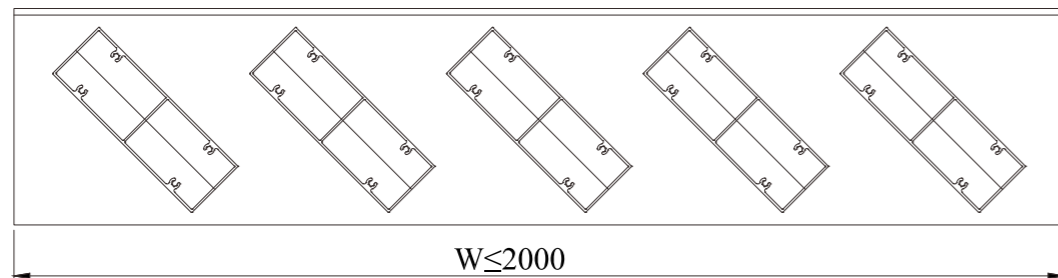
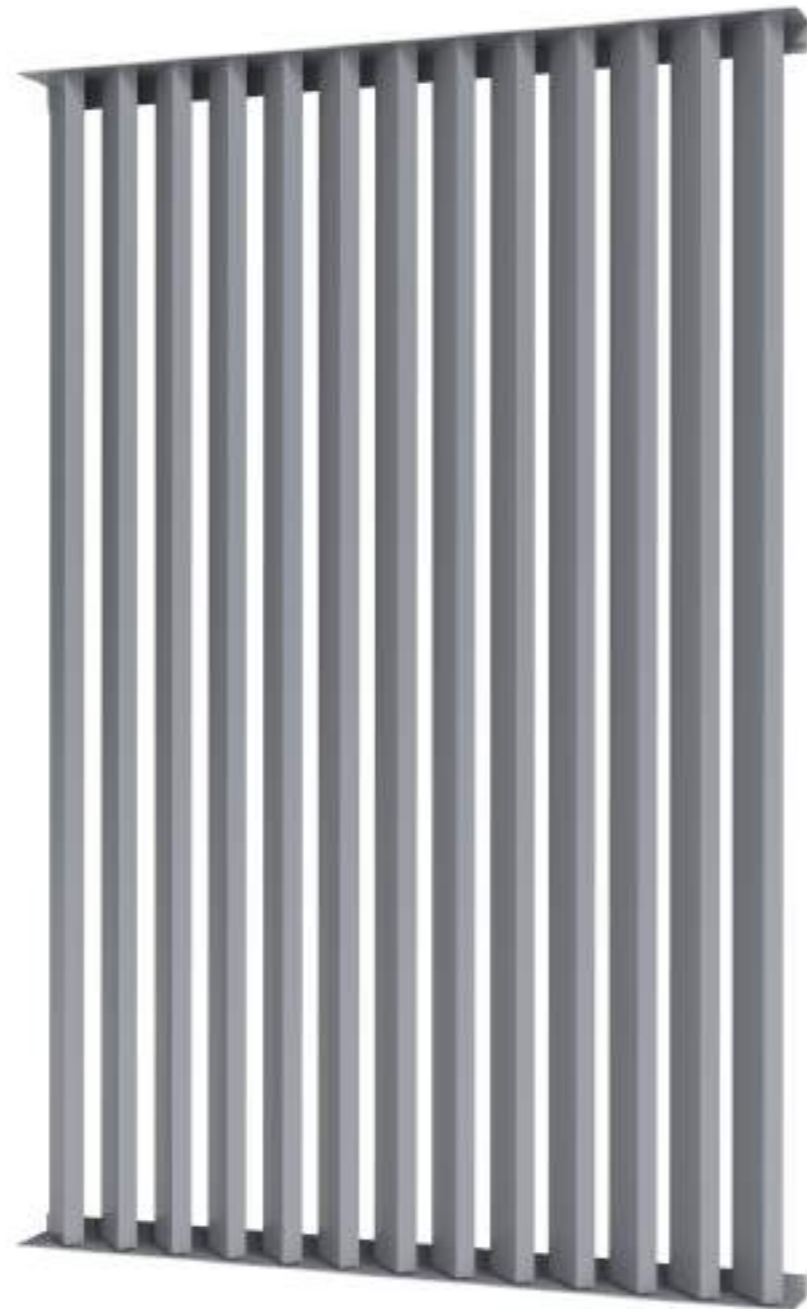

Any pitch is available.

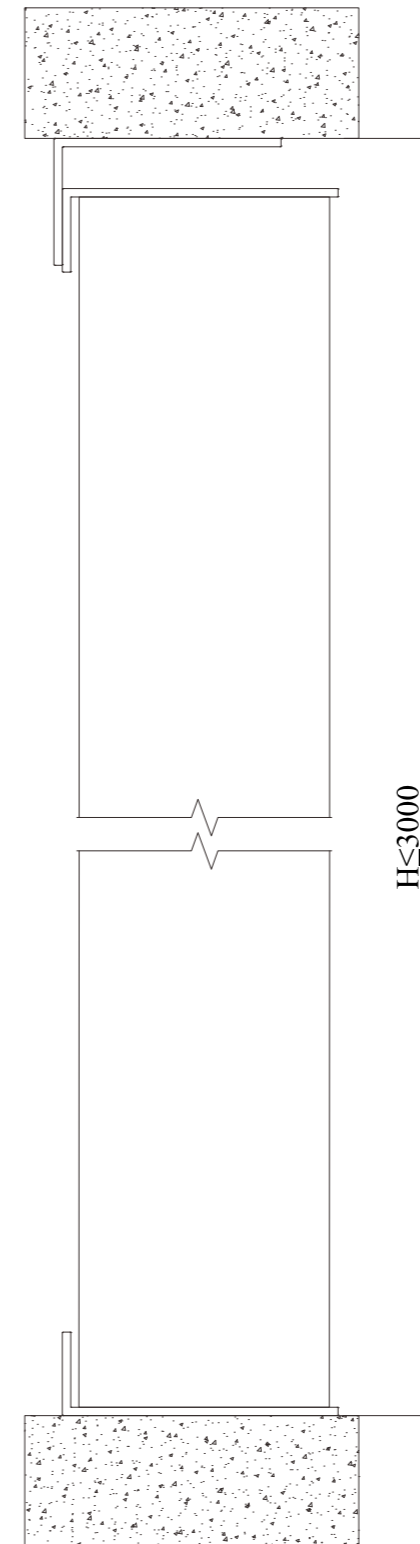

Optional blades

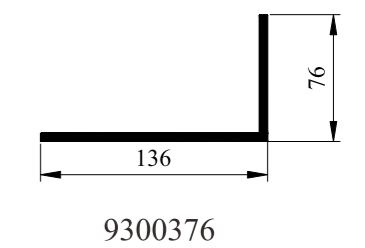
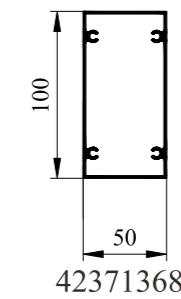
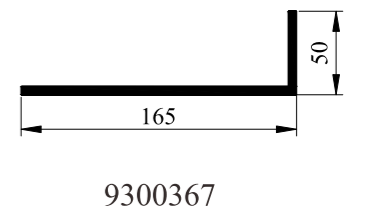
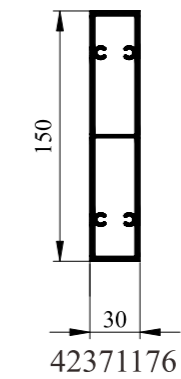
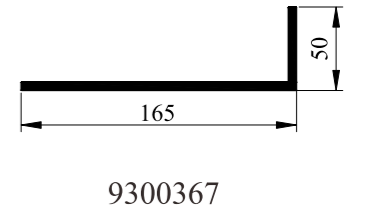
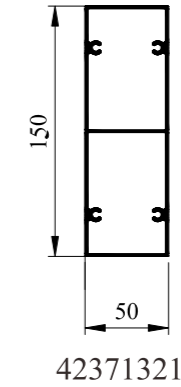

This design can be kits loose pack delivery or assembly delivery.

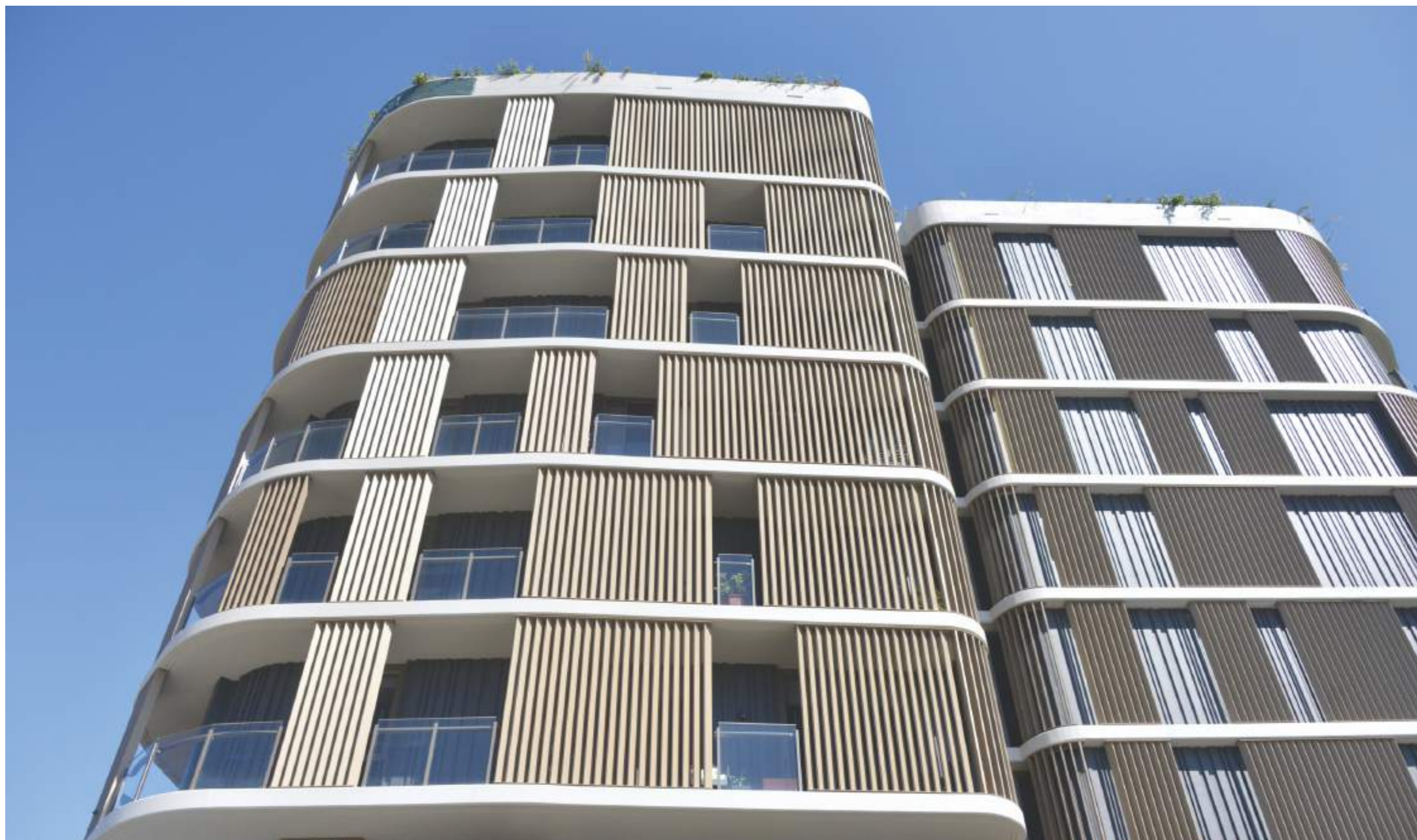

☆ both vertical and horizontal face fit on walls

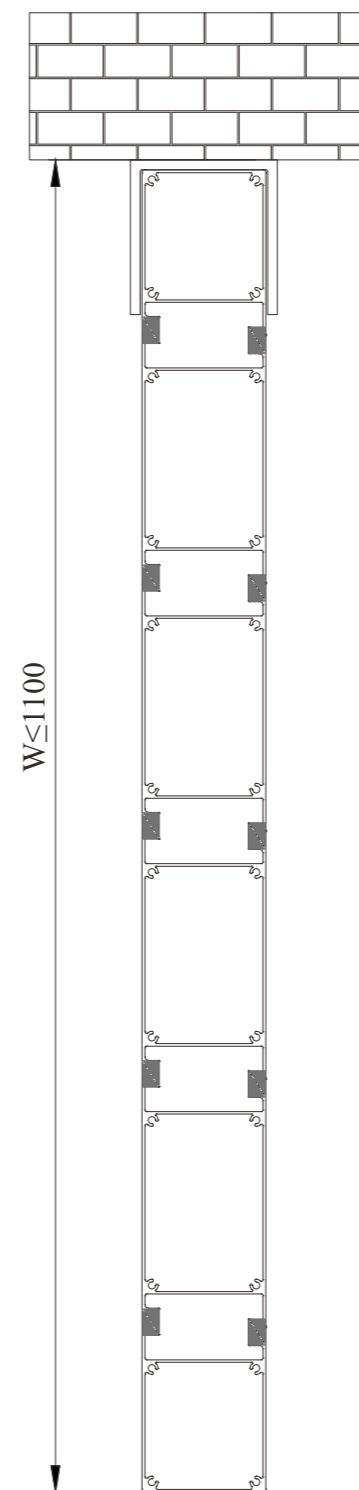
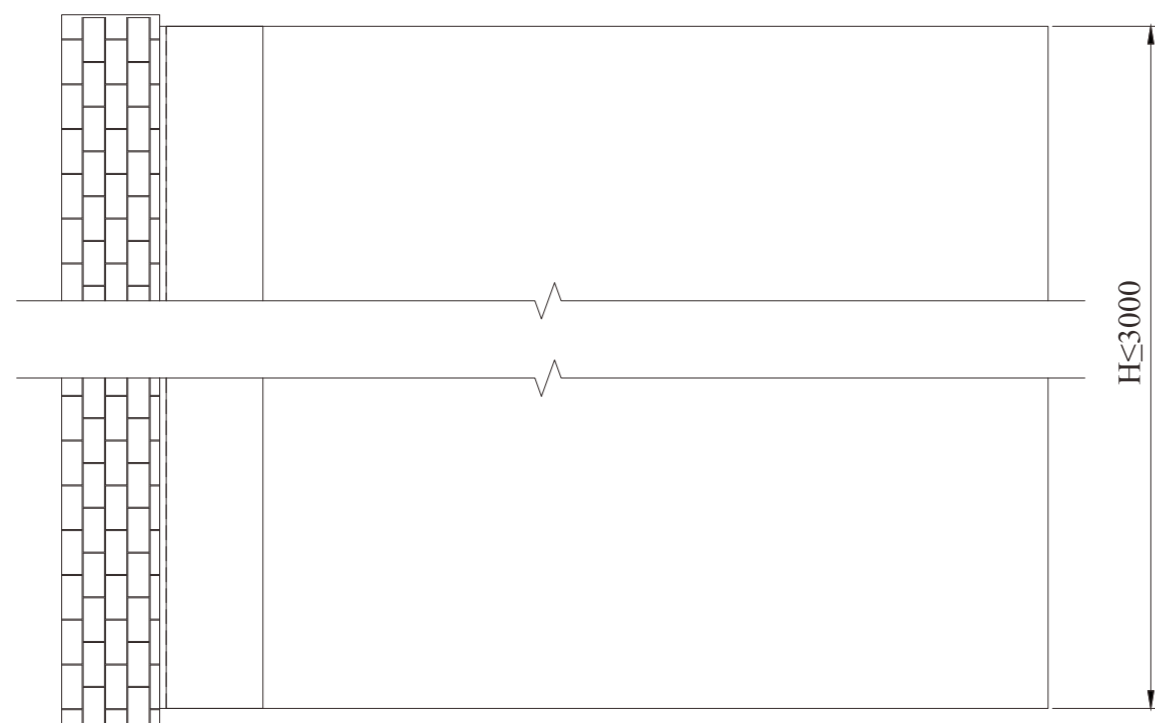
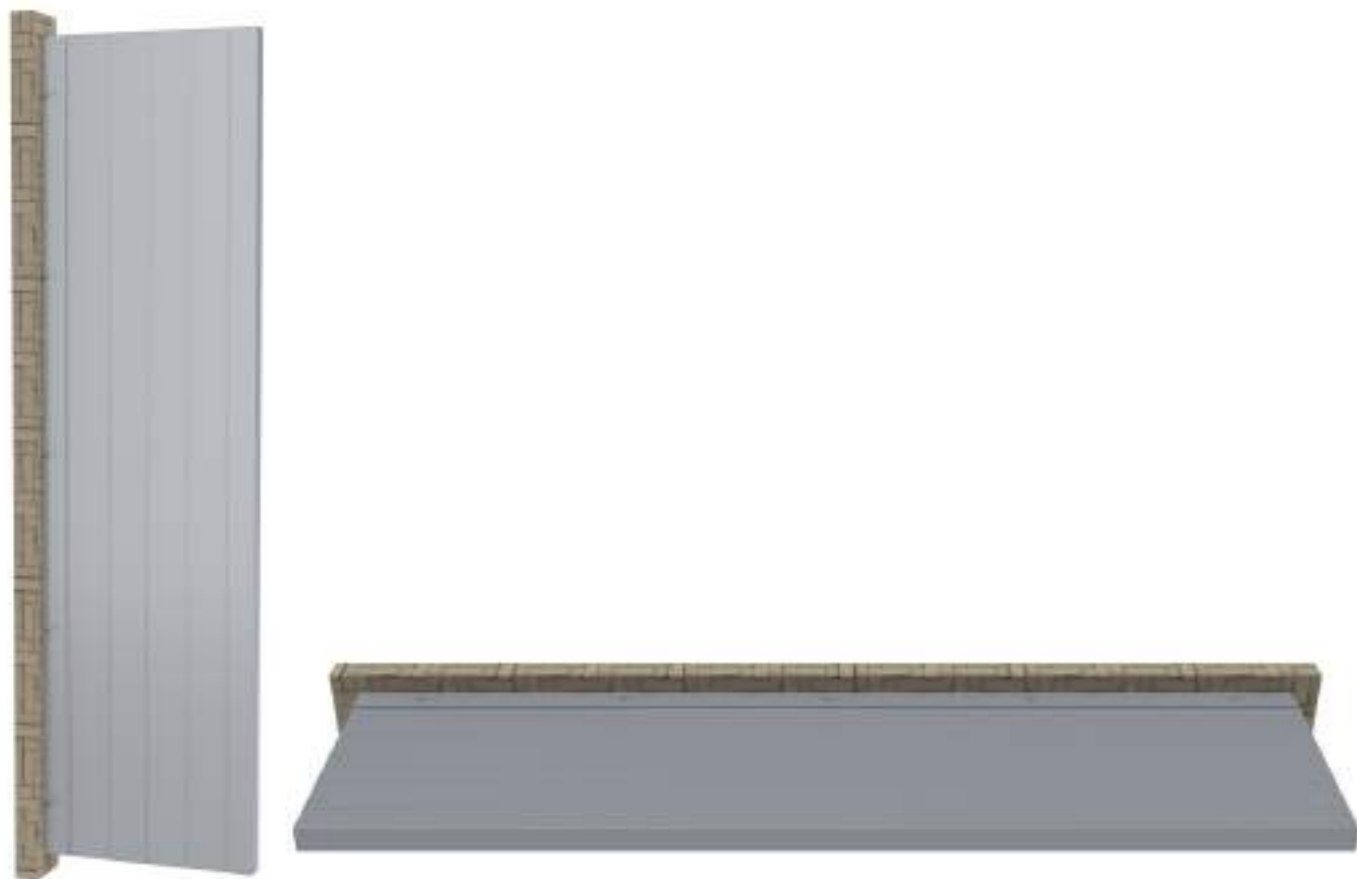

This design is assembly delivery.

75mm Panel

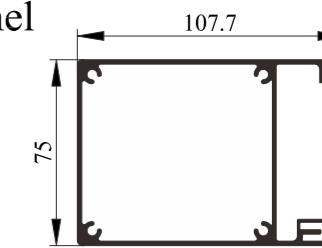

42371434

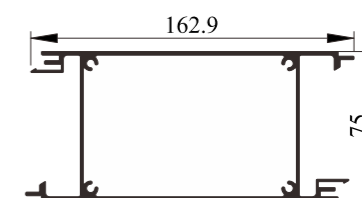

42371432

Configurations: 1100/950/806/656/506/356

50mm Panel

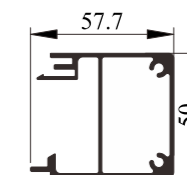

42371437

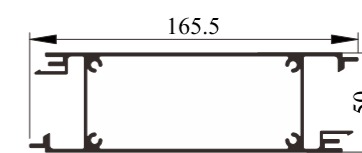

42371436

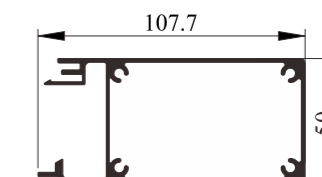

42371438

Configurations: 1050/900/750/600/450/300







☆50x50mm as frame, aluminium perforated sheet, face fit on walls

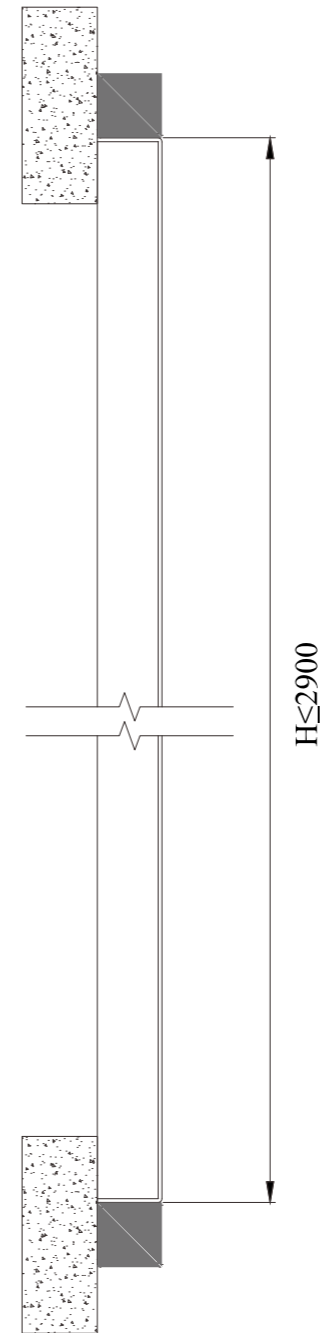
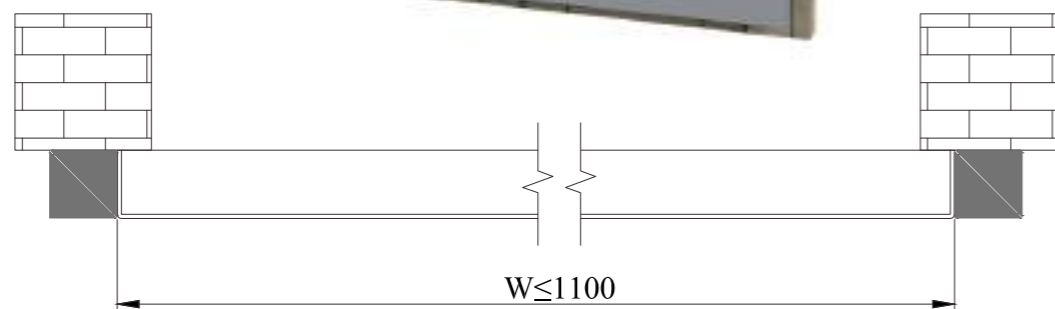

Optional patterns

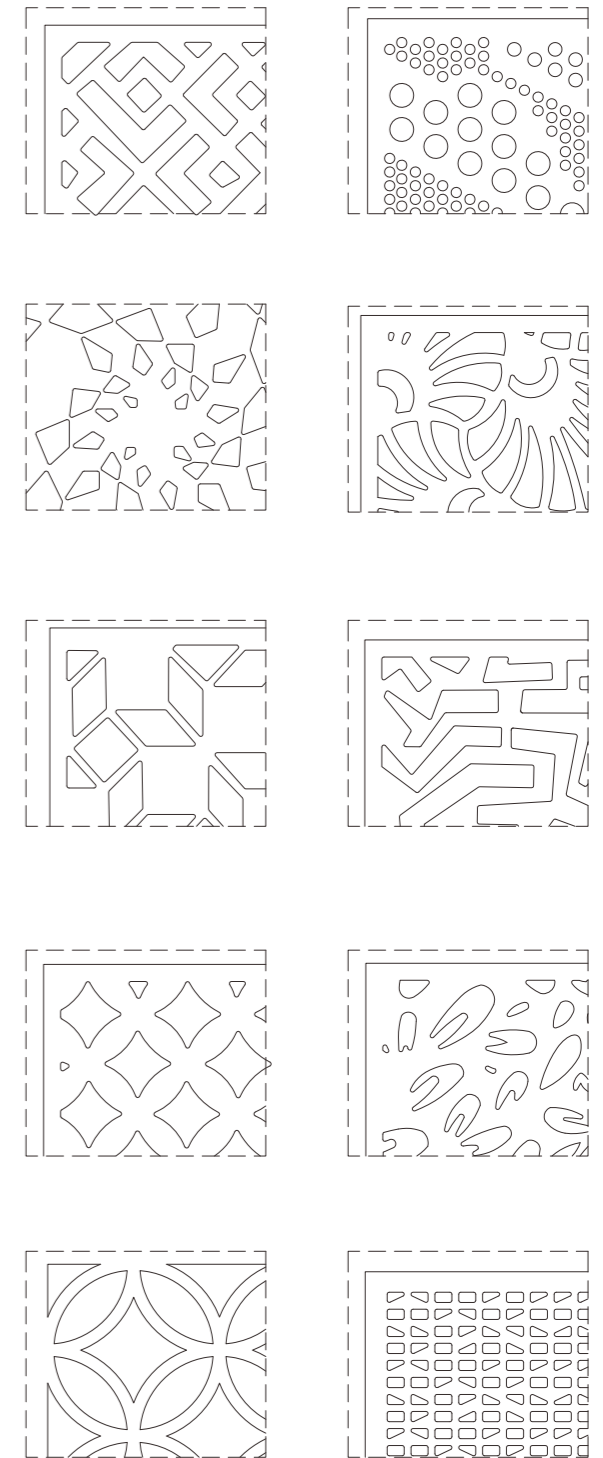

This design is kits loose pack delivery.



☆50x50mm as frame, aluminium perforated sheet,
fit between floor and ceiling

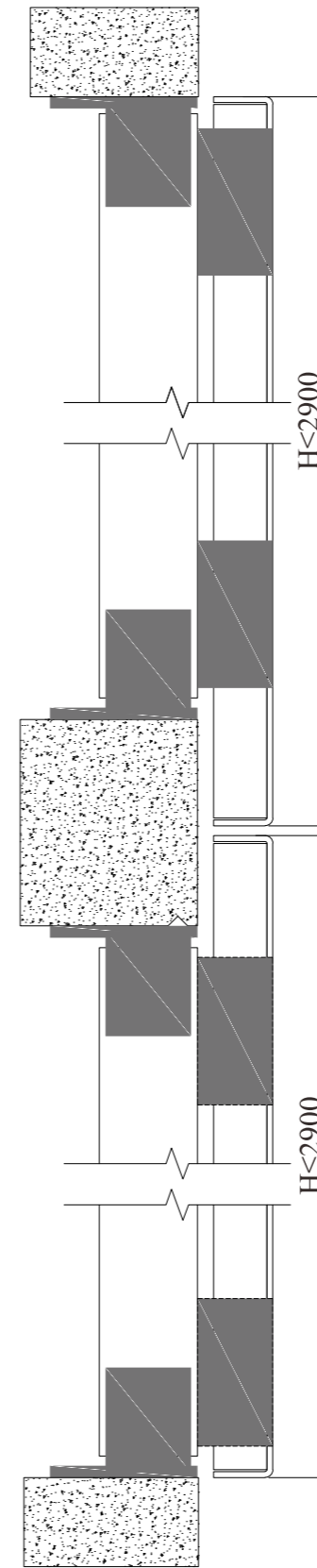
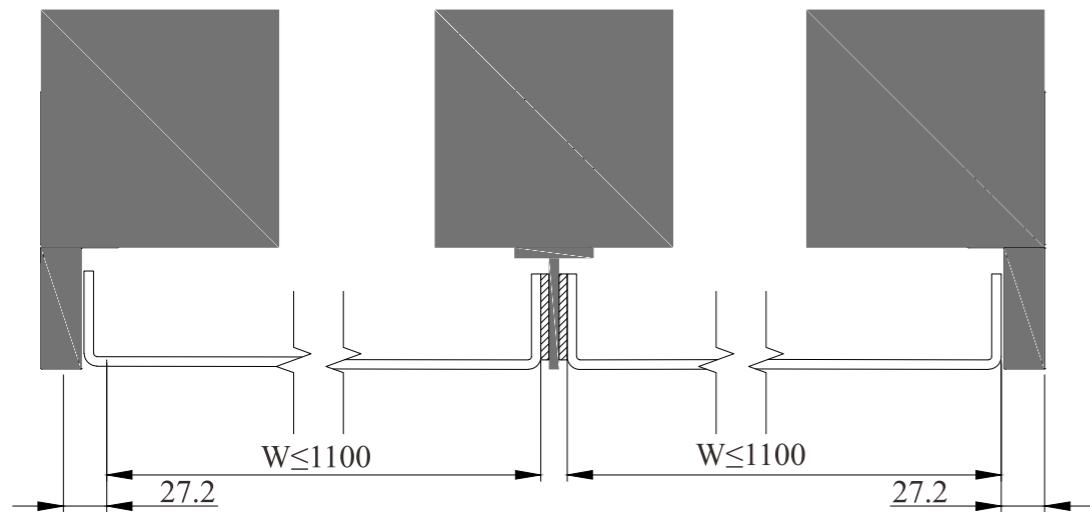

Optional patterns

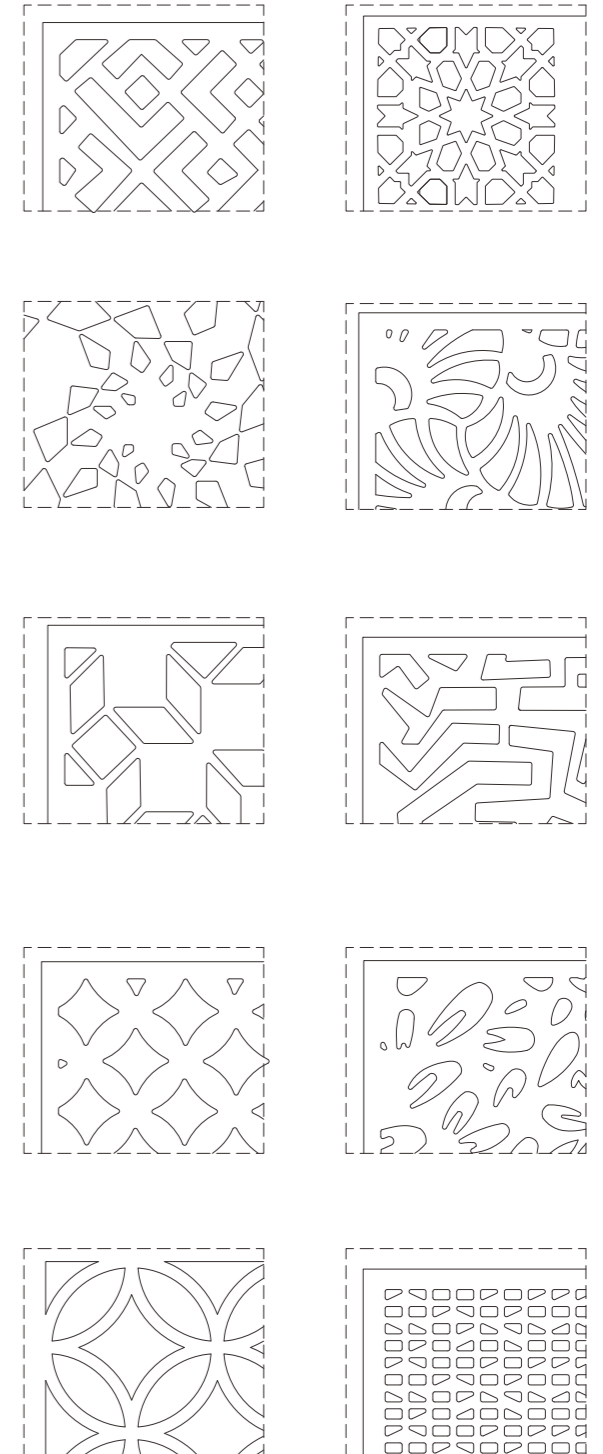

This design is kits loose pack delivery.





☆Single frame

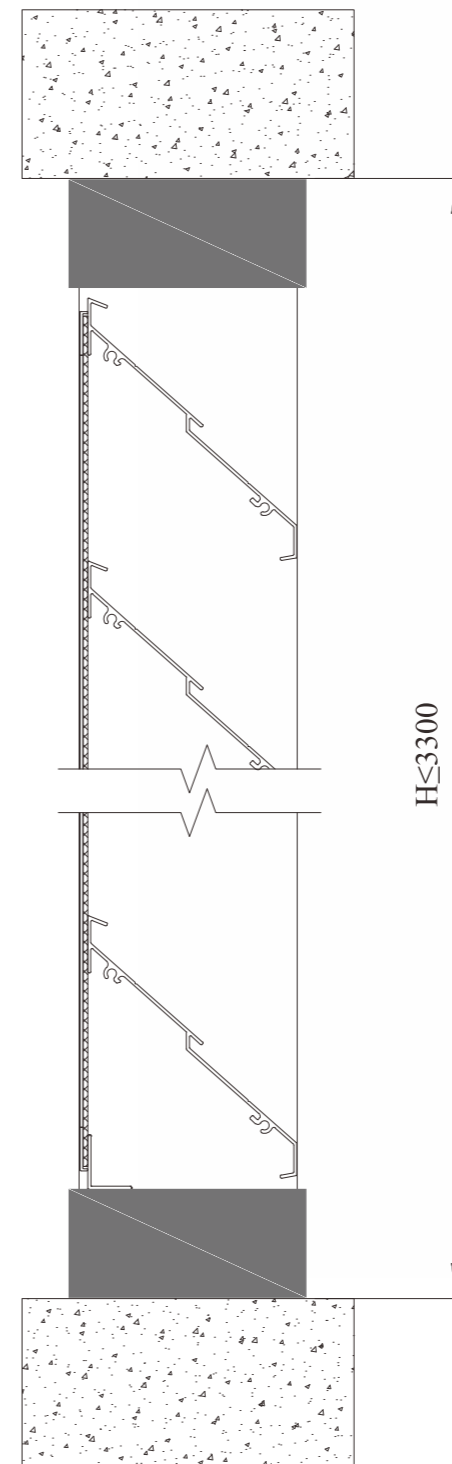
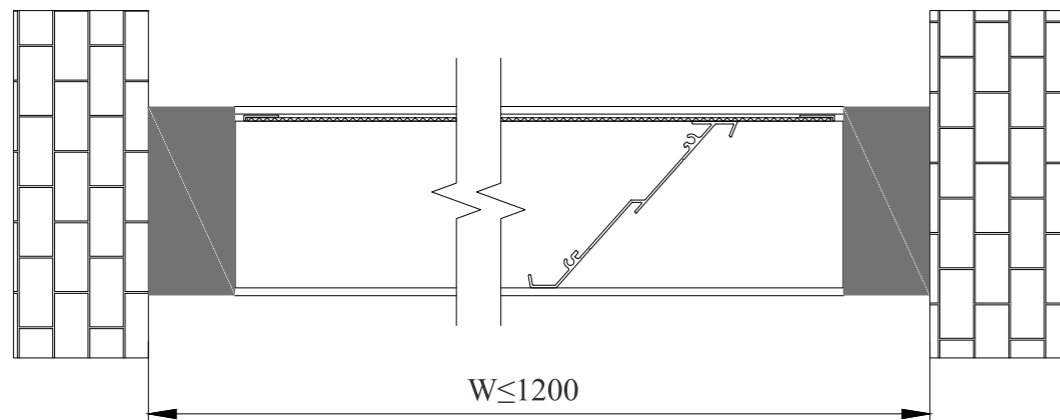

Optional blades

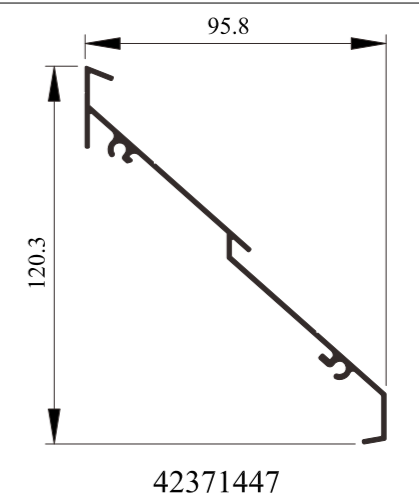
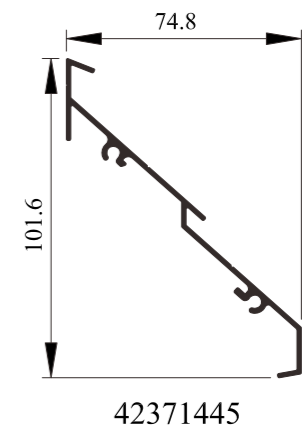
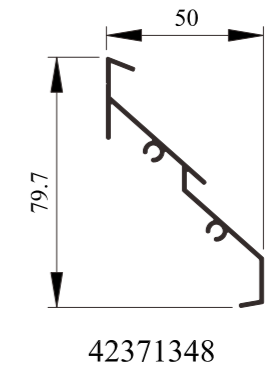

This design can be kits loose pack delivery or assembly delivery.



☆ Frame with middle frame

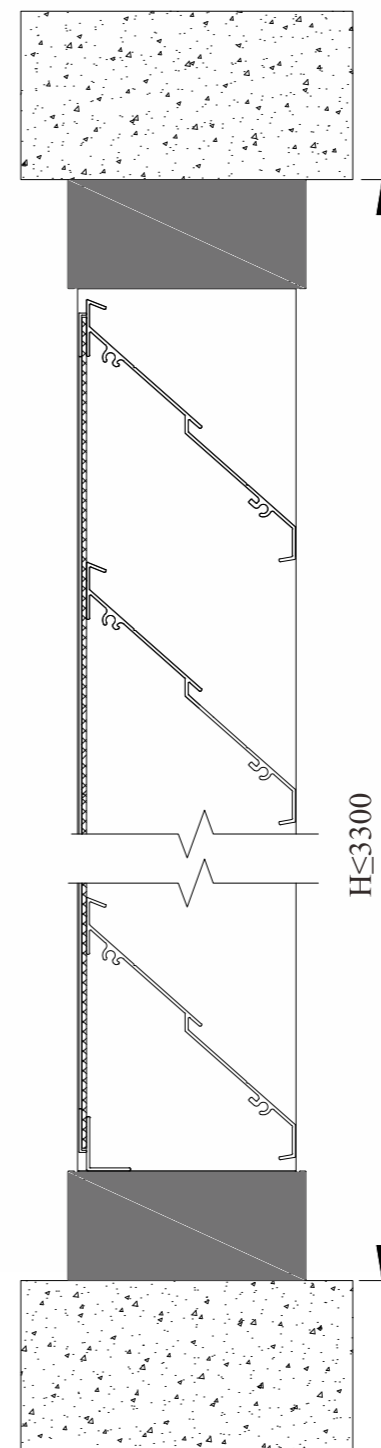
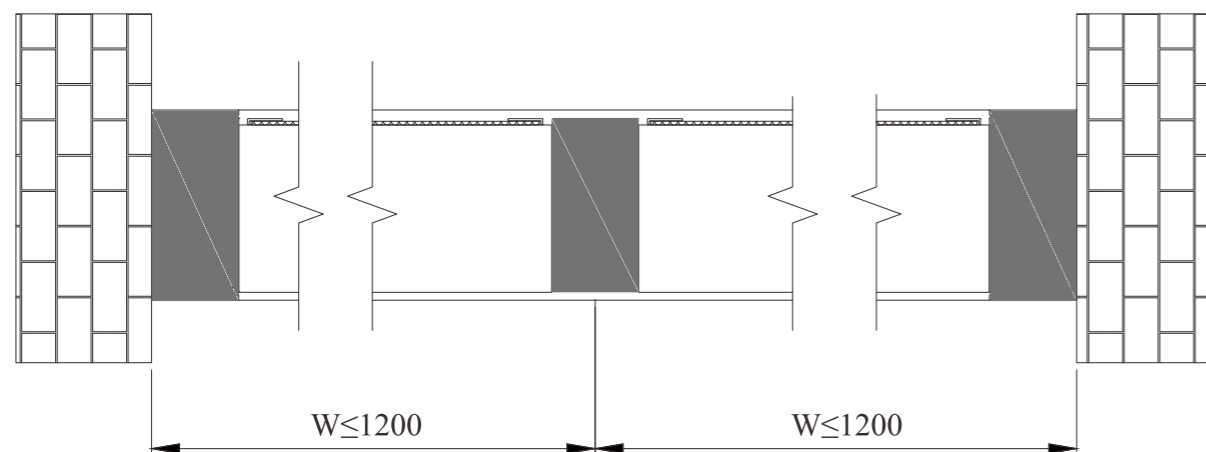

Optional blades

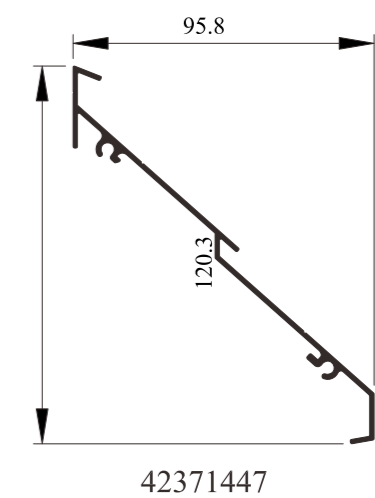
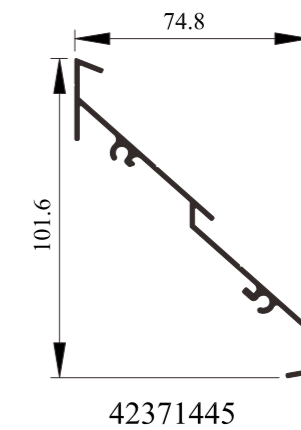
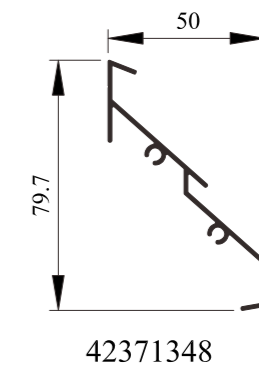

This design can be kits loose pack delivery or assembly delivery.



☆ Frame with middle frame and middle rail

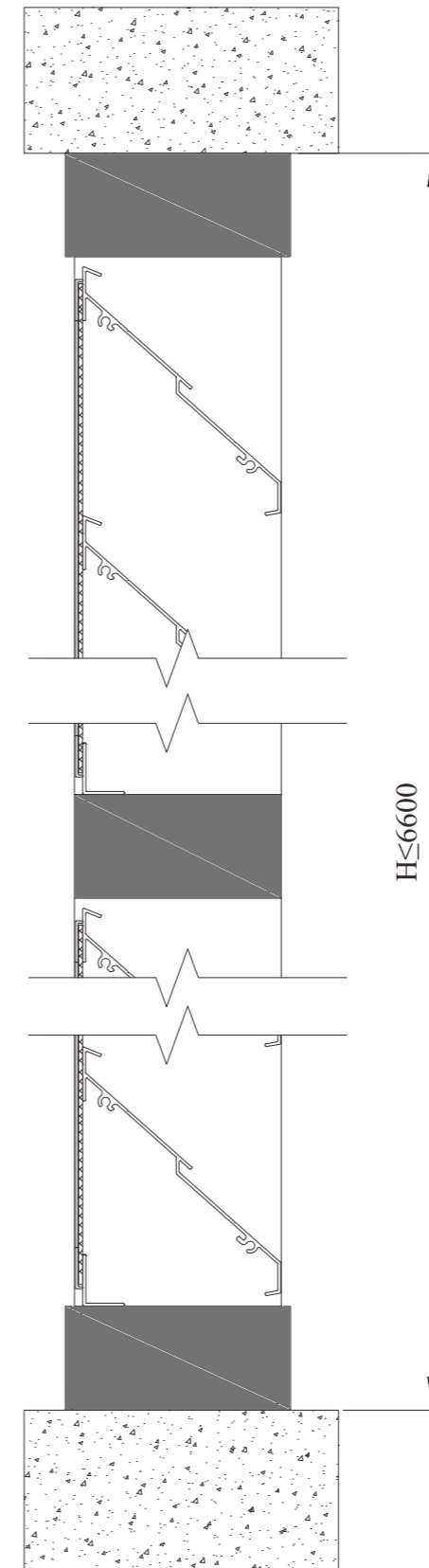
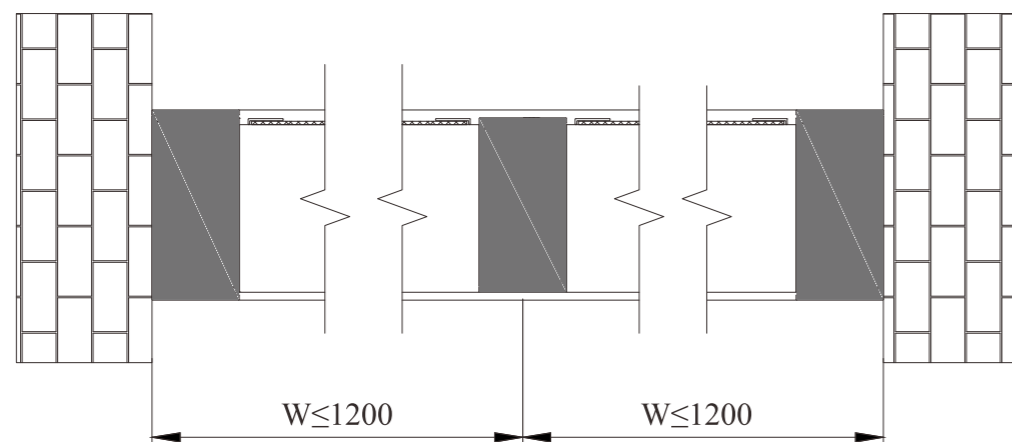

Optional blades

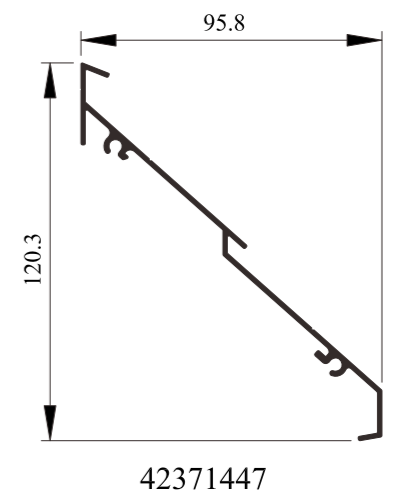
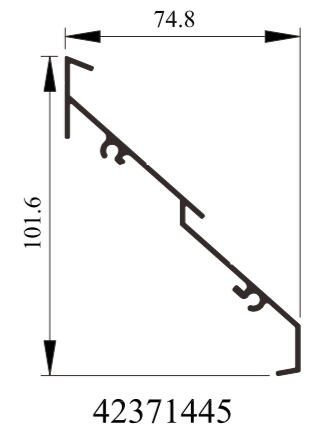
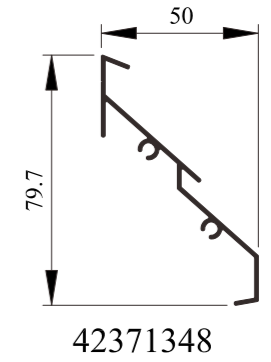

This design can be kits loose pack delivery or assembly delivery.



☆NO frame, posts are hidden in the back

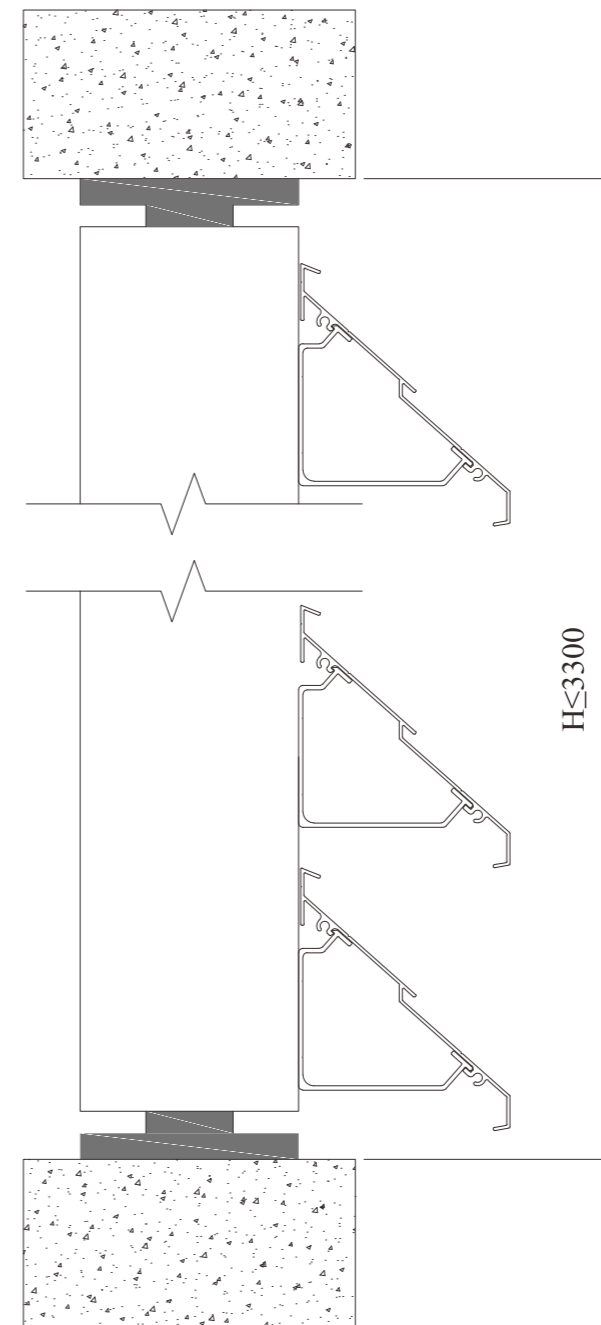
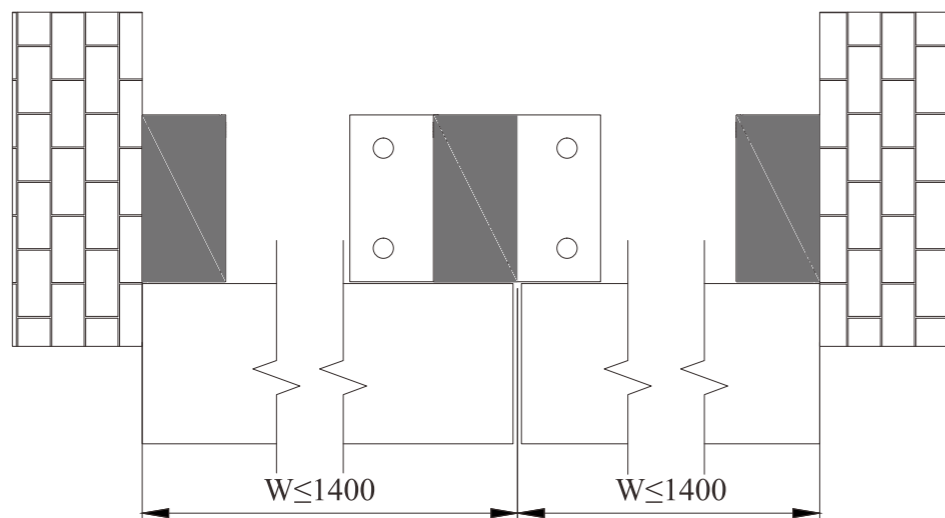

Optional blades

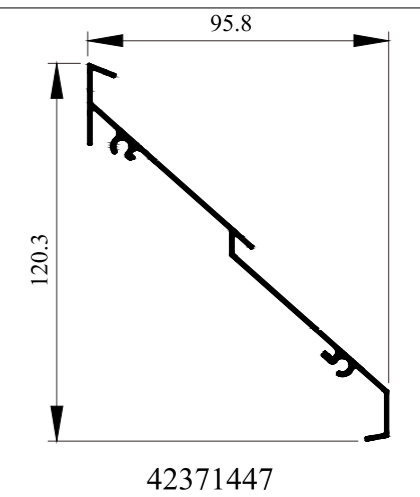
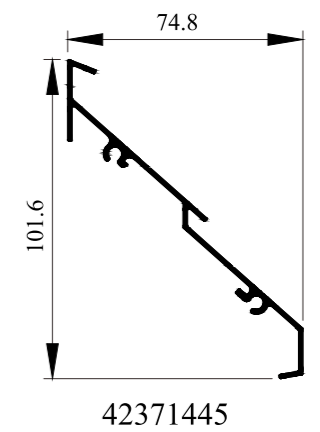
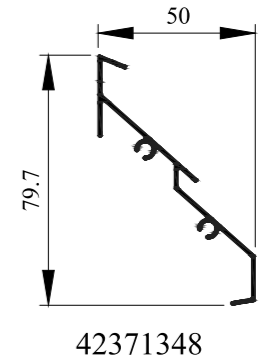

This design can be kits loose pack delivery or assembly delivery.



☆ WITH frame, middle frames are hidden in the back

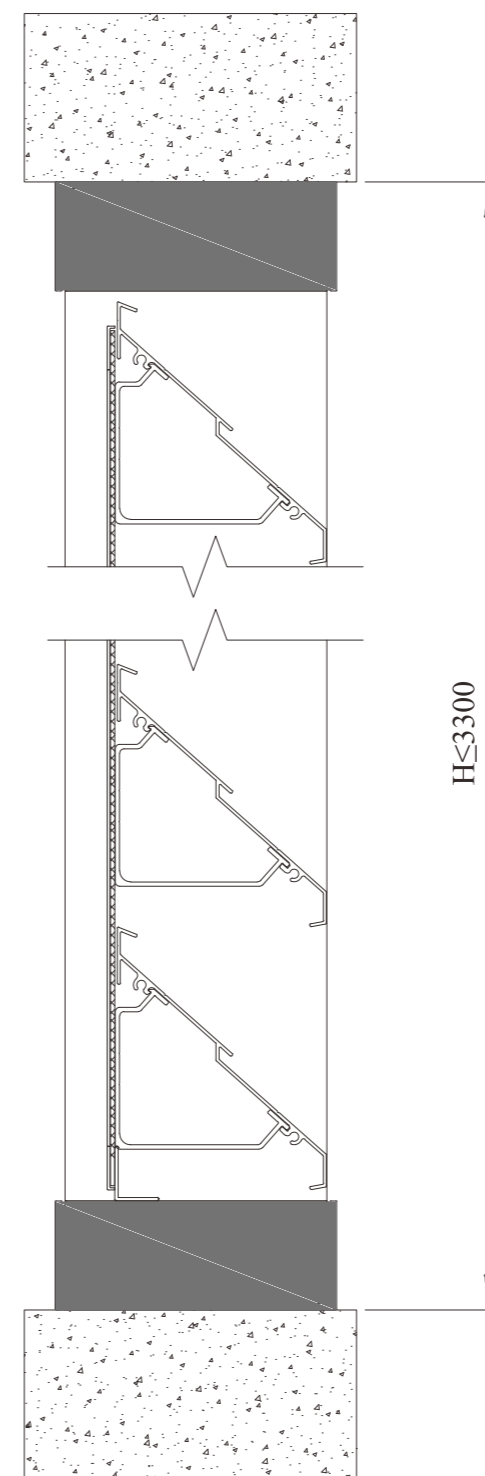
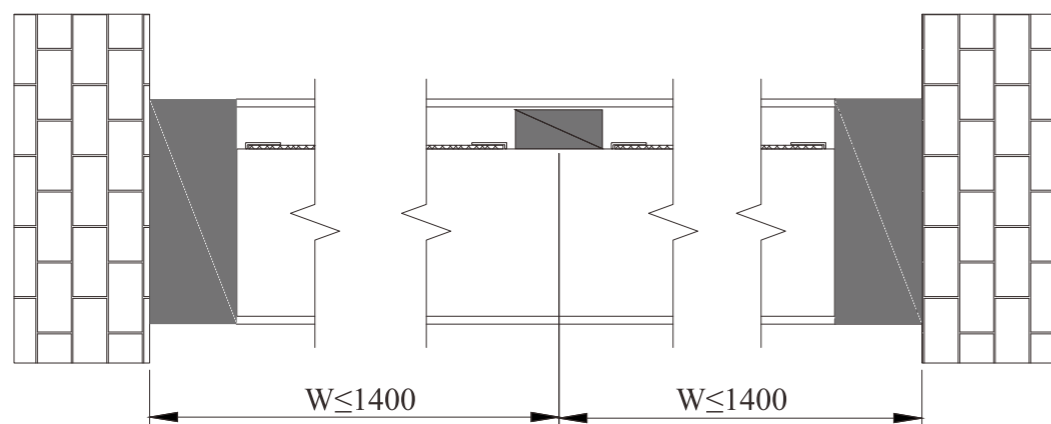

Optional blades

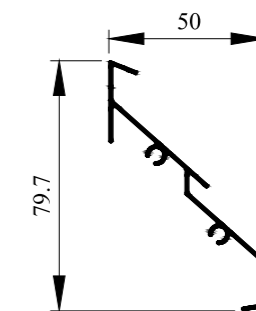

42371348

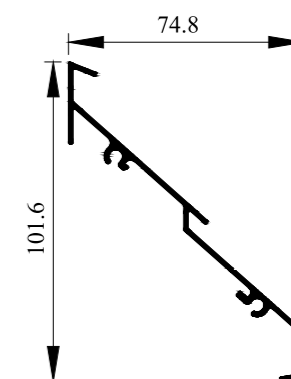

42371445

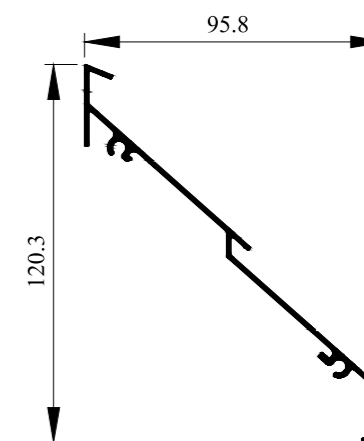

42371447

This design can be kits loose pack delivery or assembly delivery.



☆ Economy style

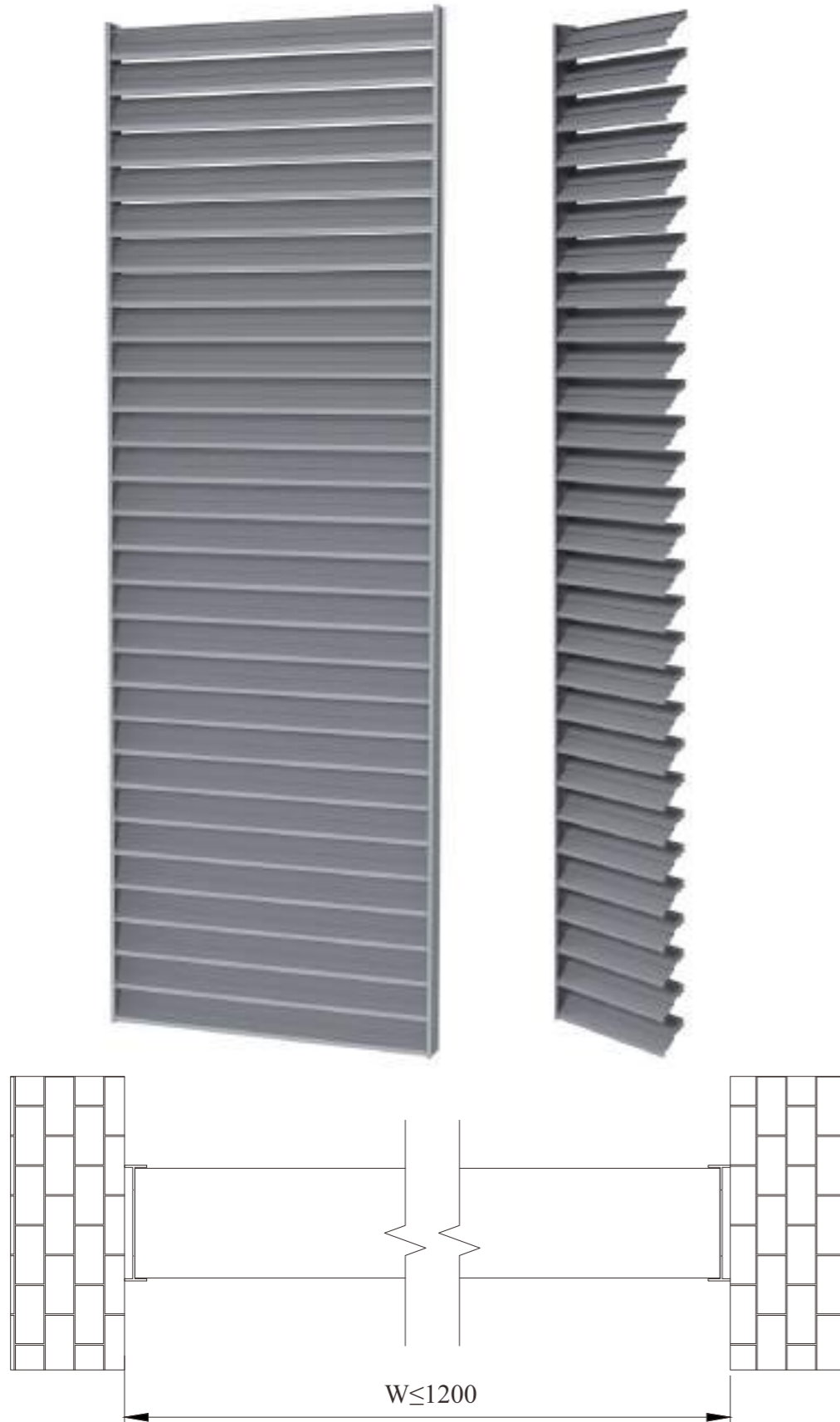

Optional blades

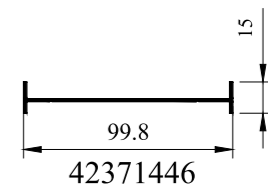
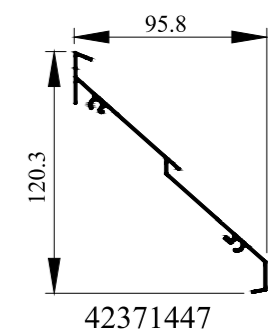
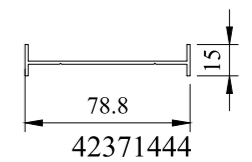
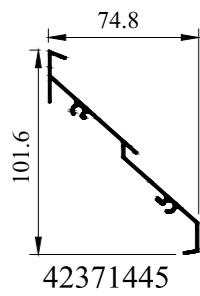
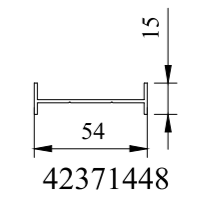
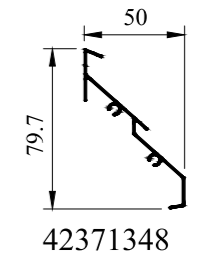
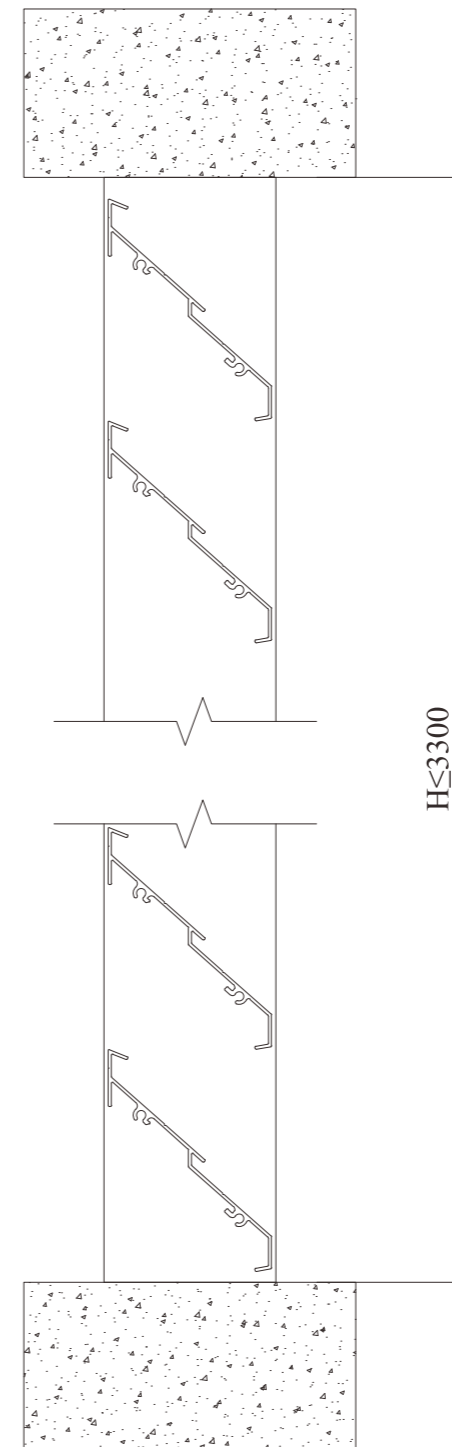

This design can be kits loose pack delivery or assembly delivery.



☆Z Type and L Type, fit between floor and ceiling

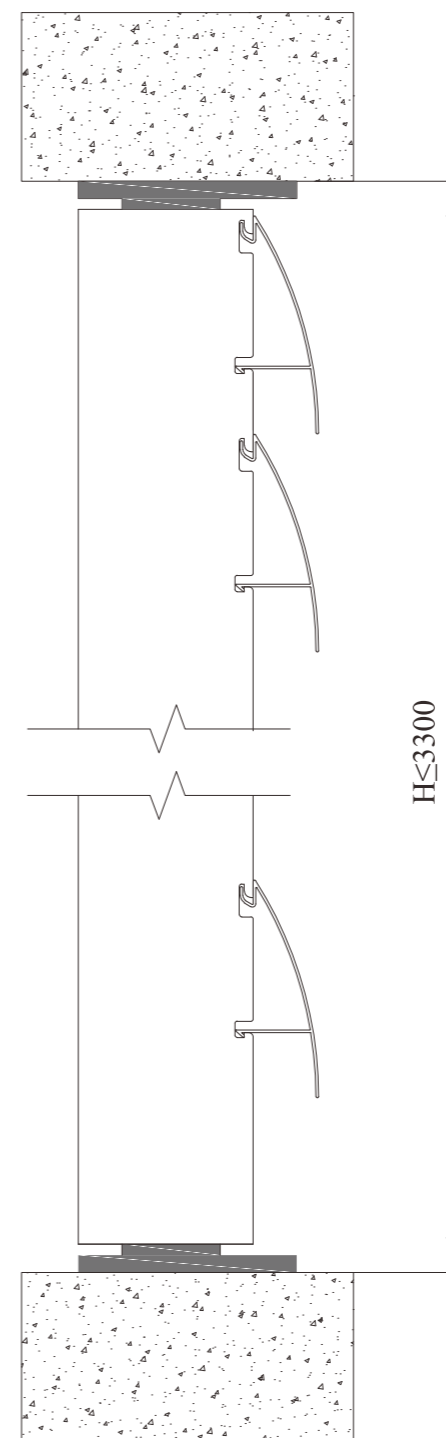
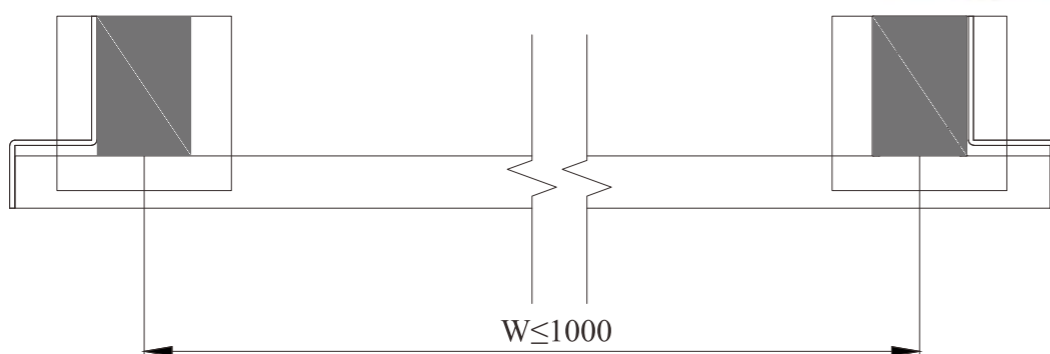

Optional blades

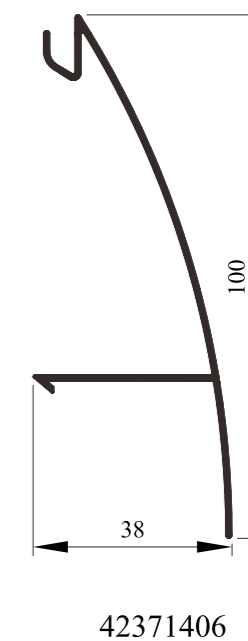
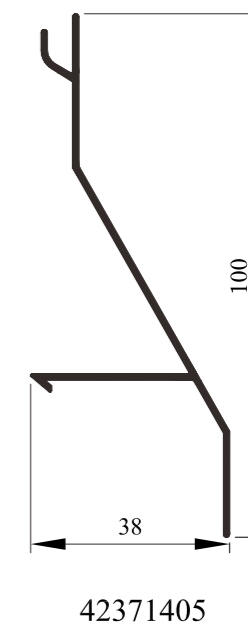

This design can be kits loose pack delivery or assembly delivery.

☆ Z Type and L Type, face fit on walls

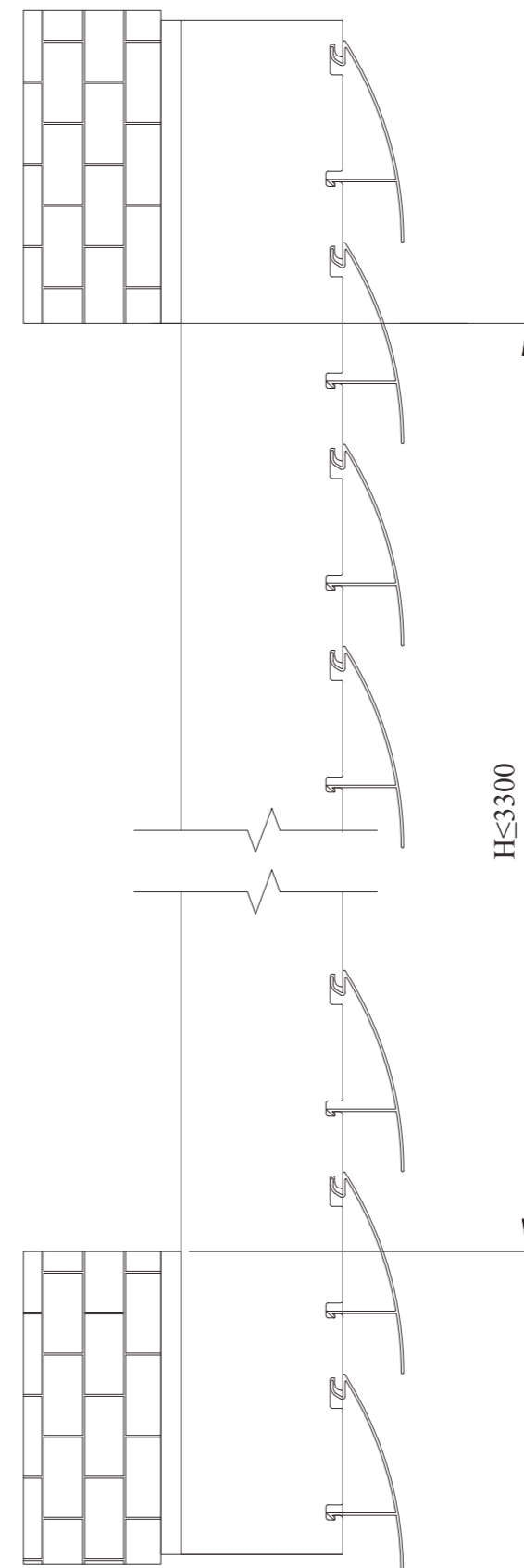
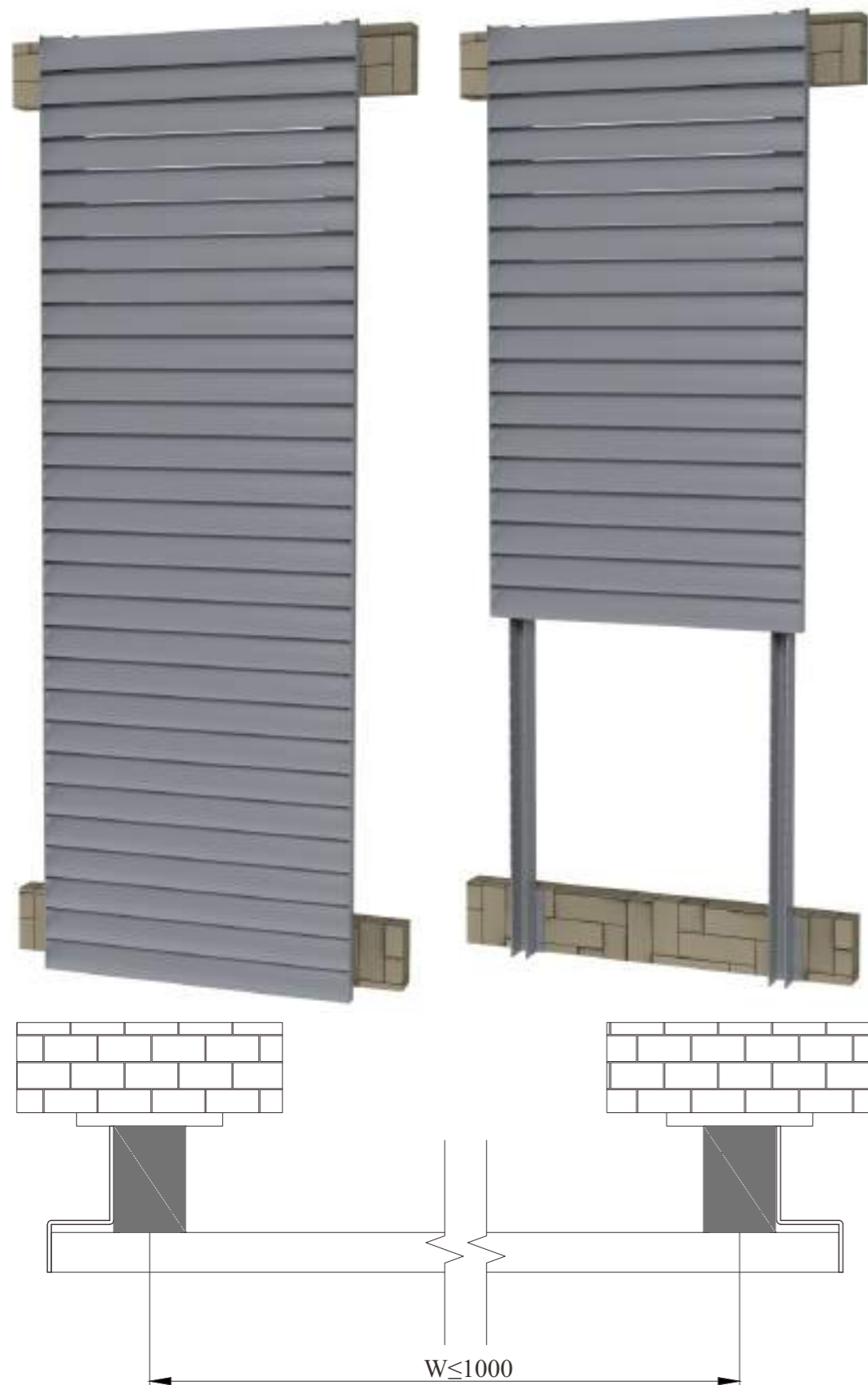

Optional blades

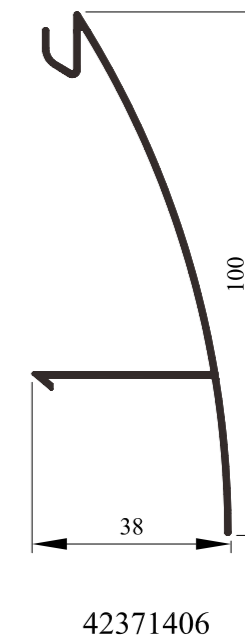
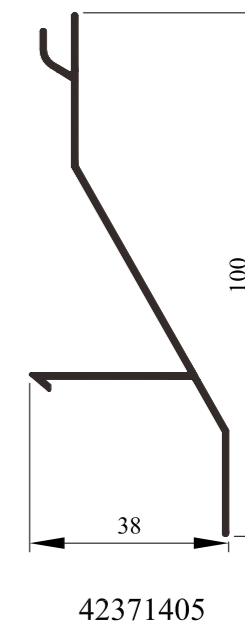

This design can be kits loose pack delivery or assembly delivery.

☆ both vertical and horizontal face fit on walls

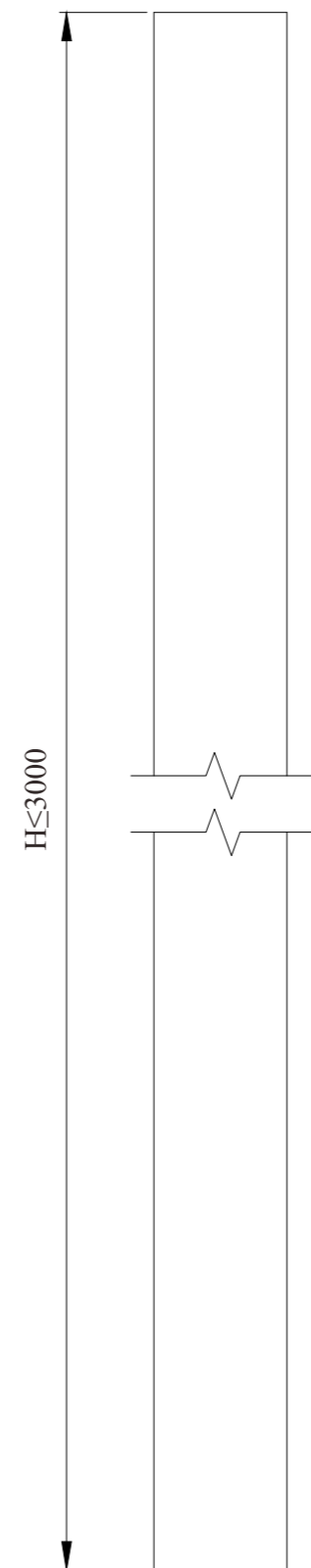
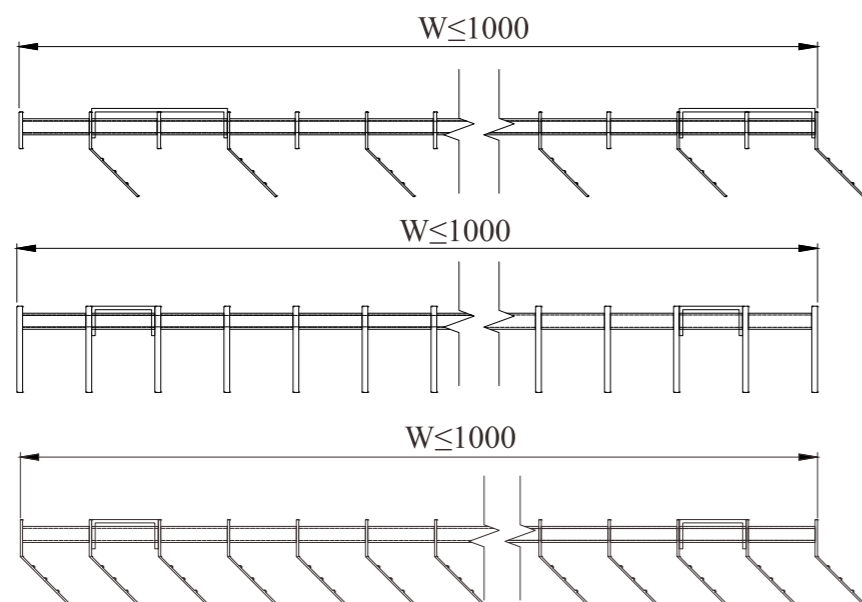
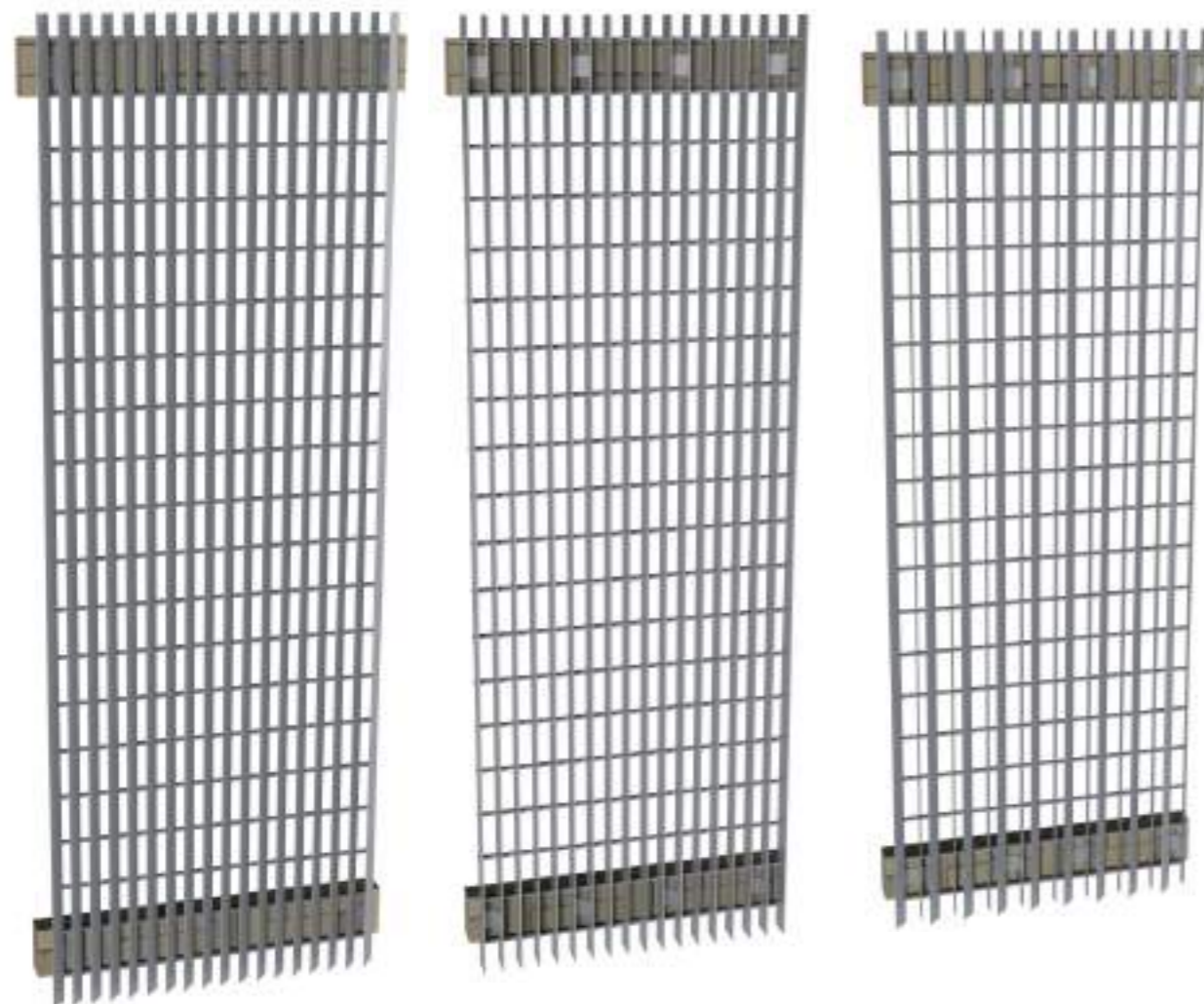

Optional blades

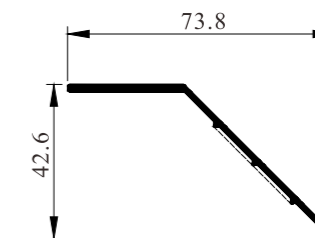

4237838

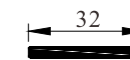

920015



9200315



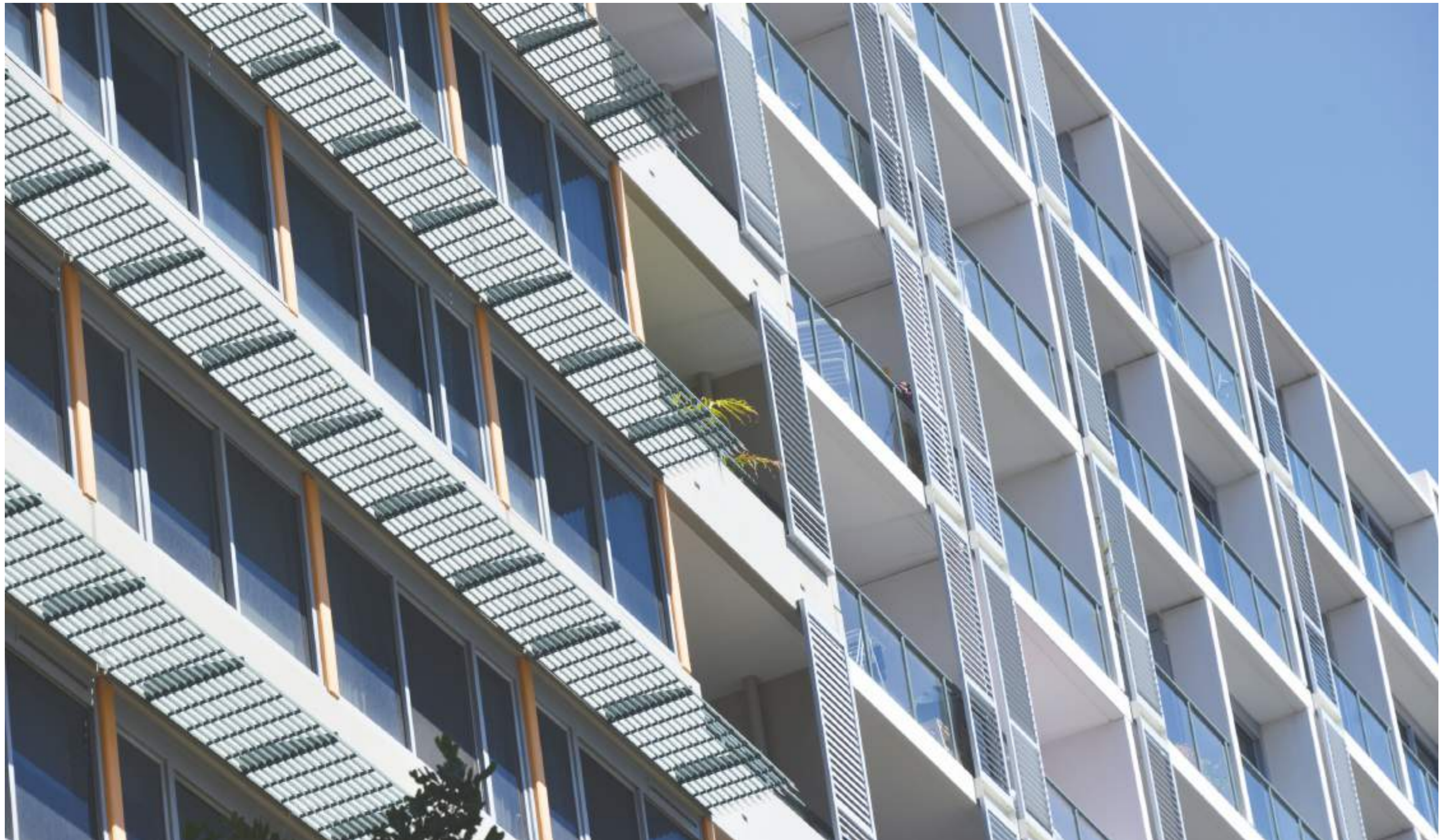

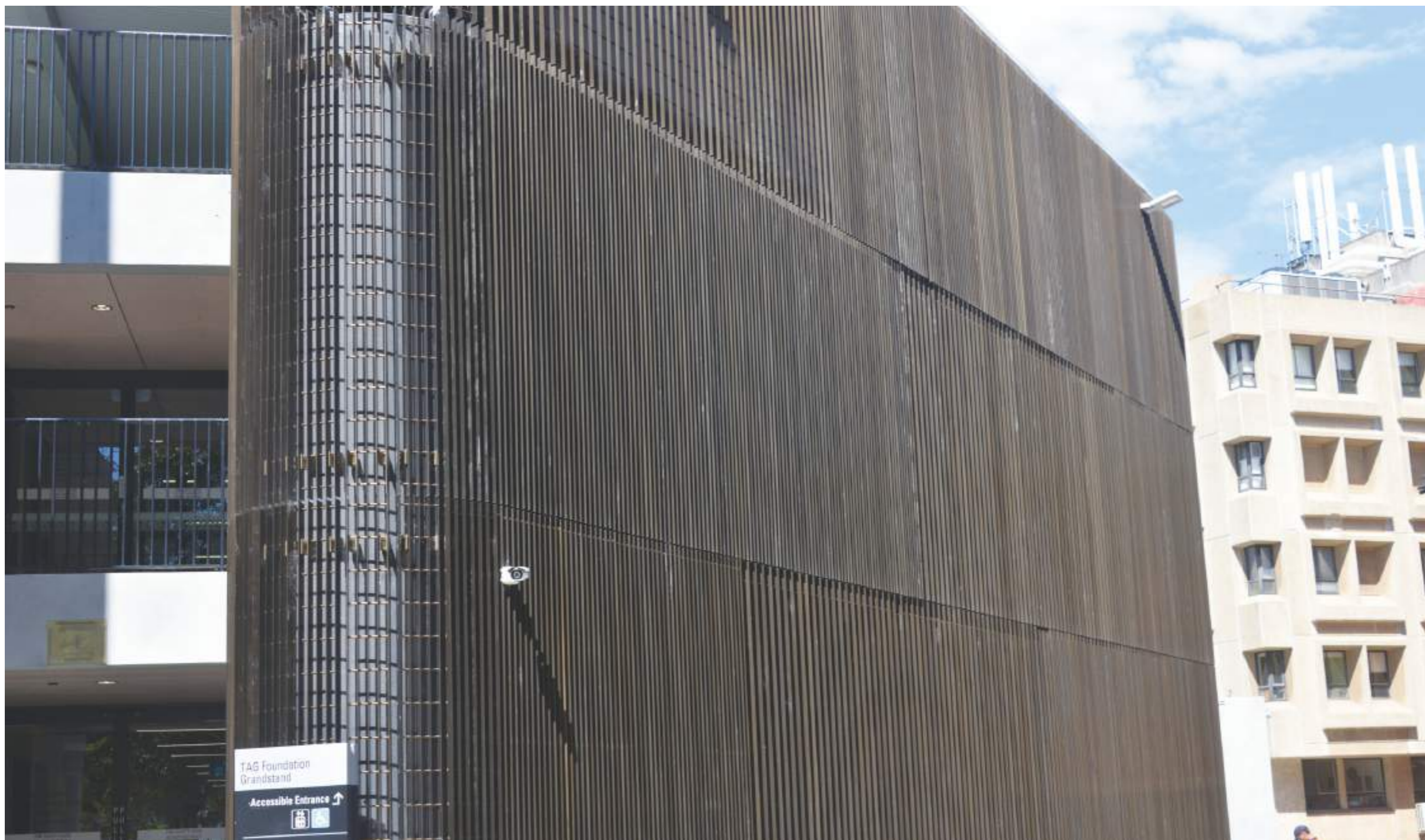

☆ Motorized operable blades, but NON waterproof

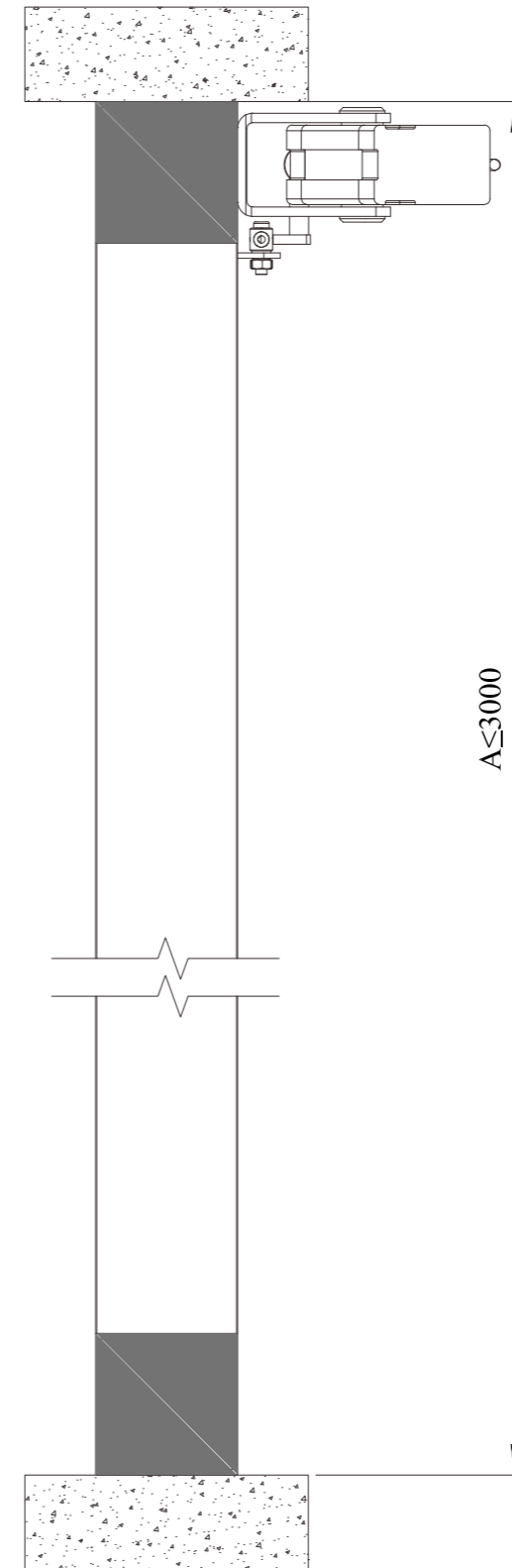
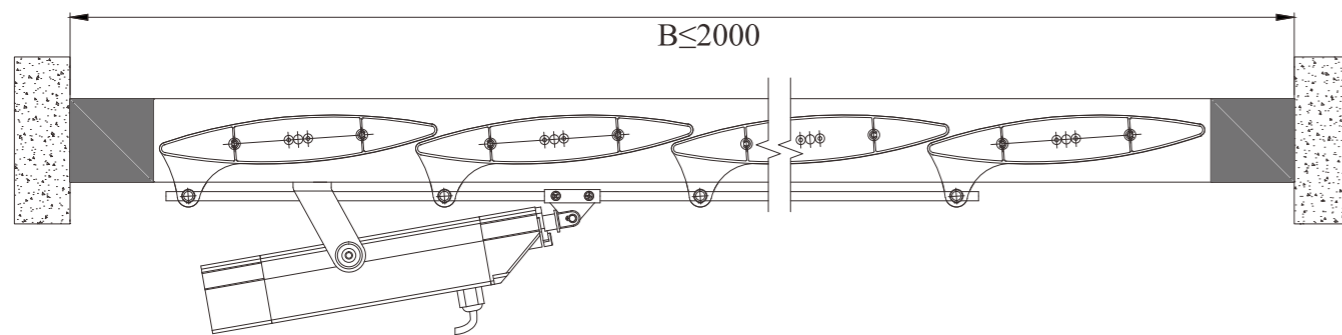
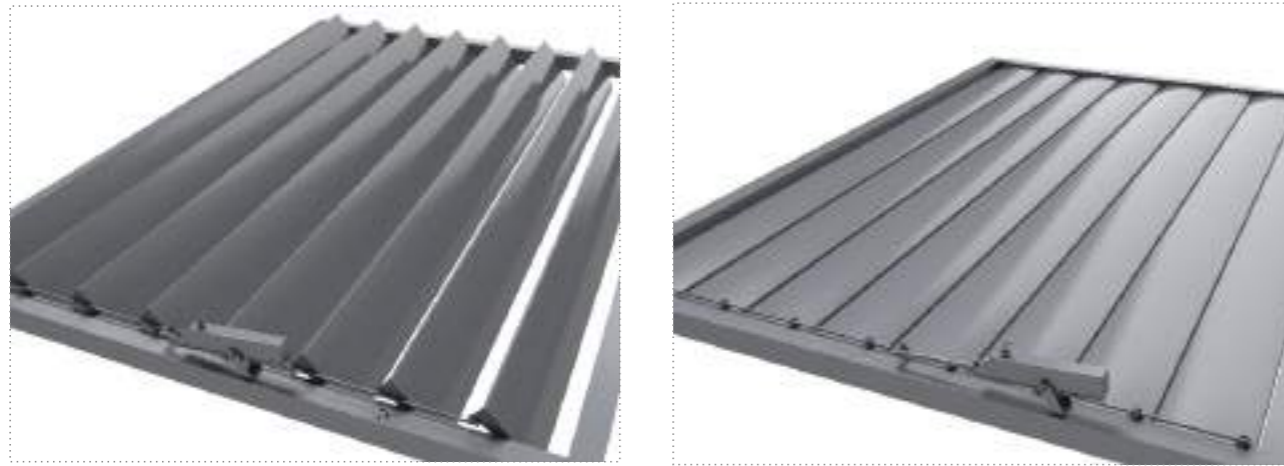

Optional blades

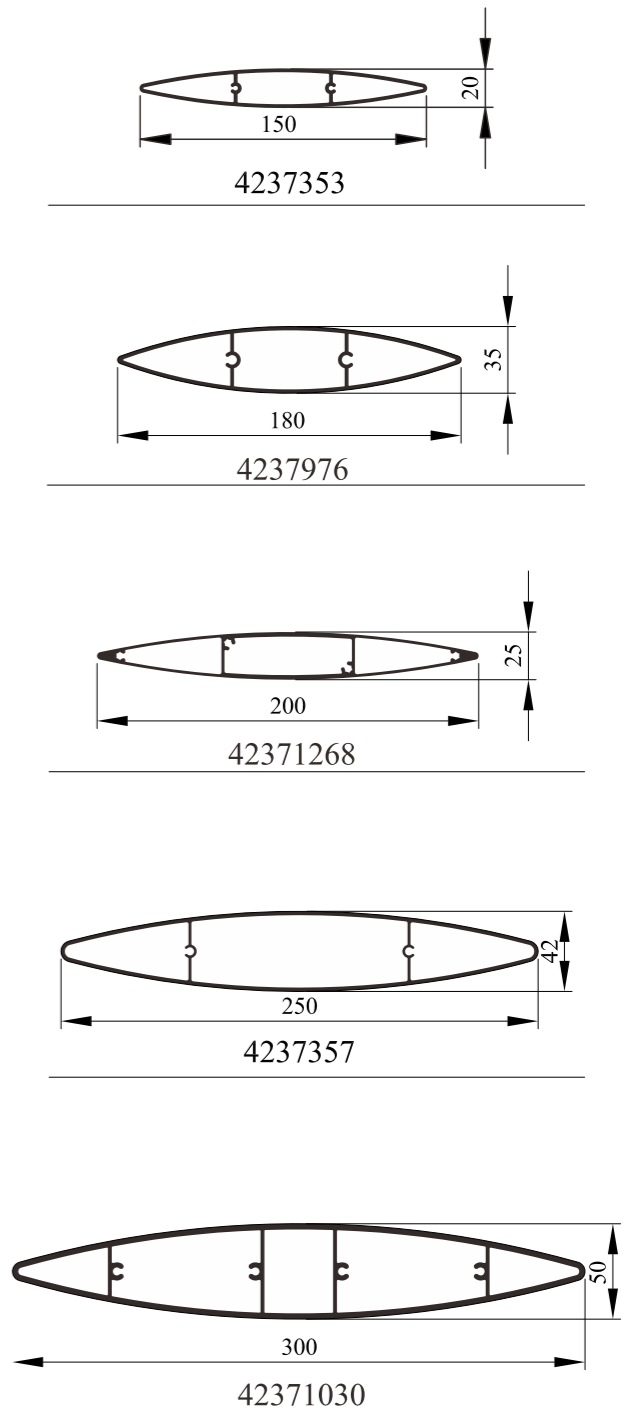

This design can be kits loose pack delivery.



☆ Motorized operable blades, and WATERPROOF

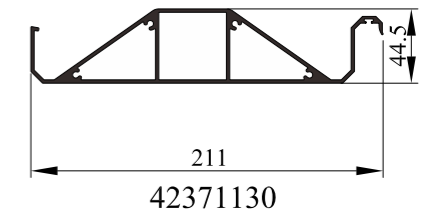
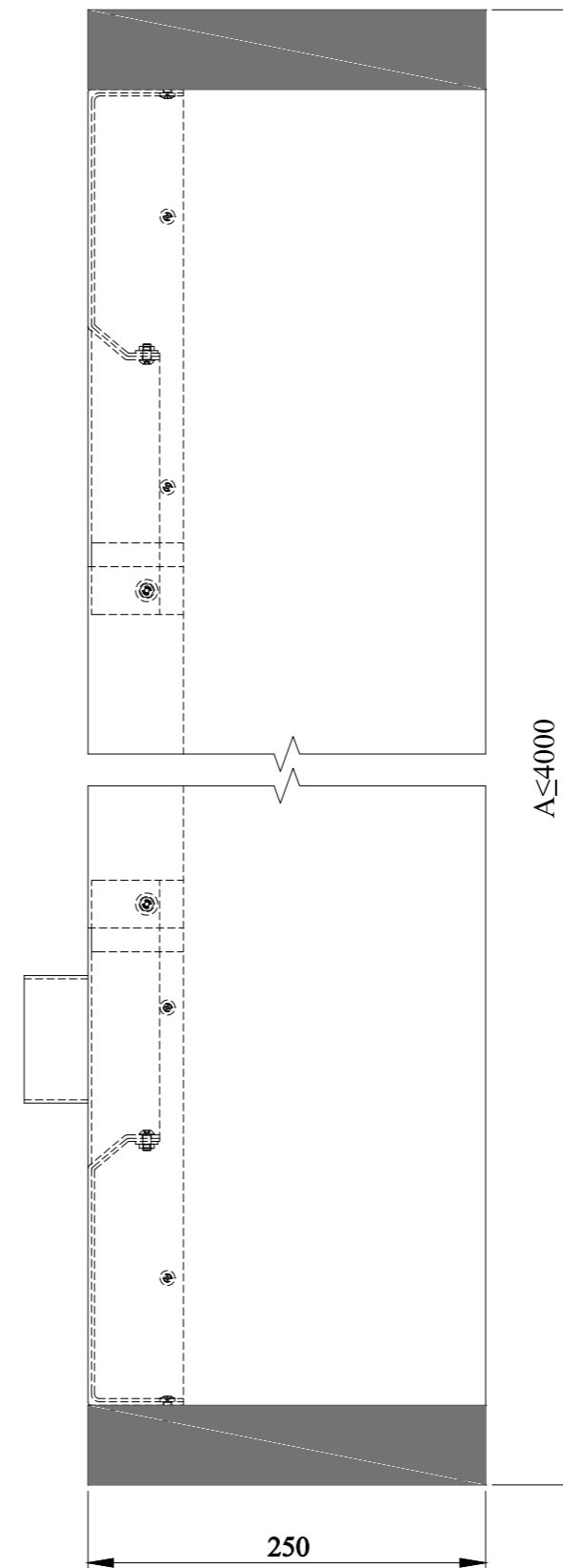
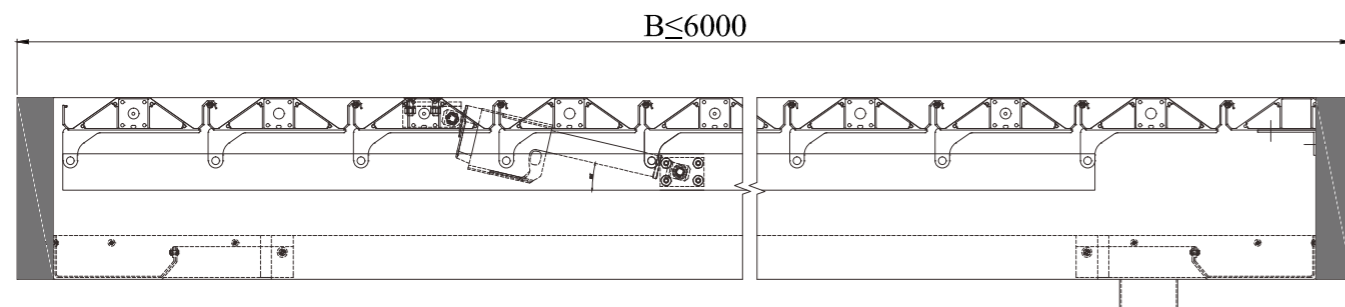

This design can be kits loose pack delivery.











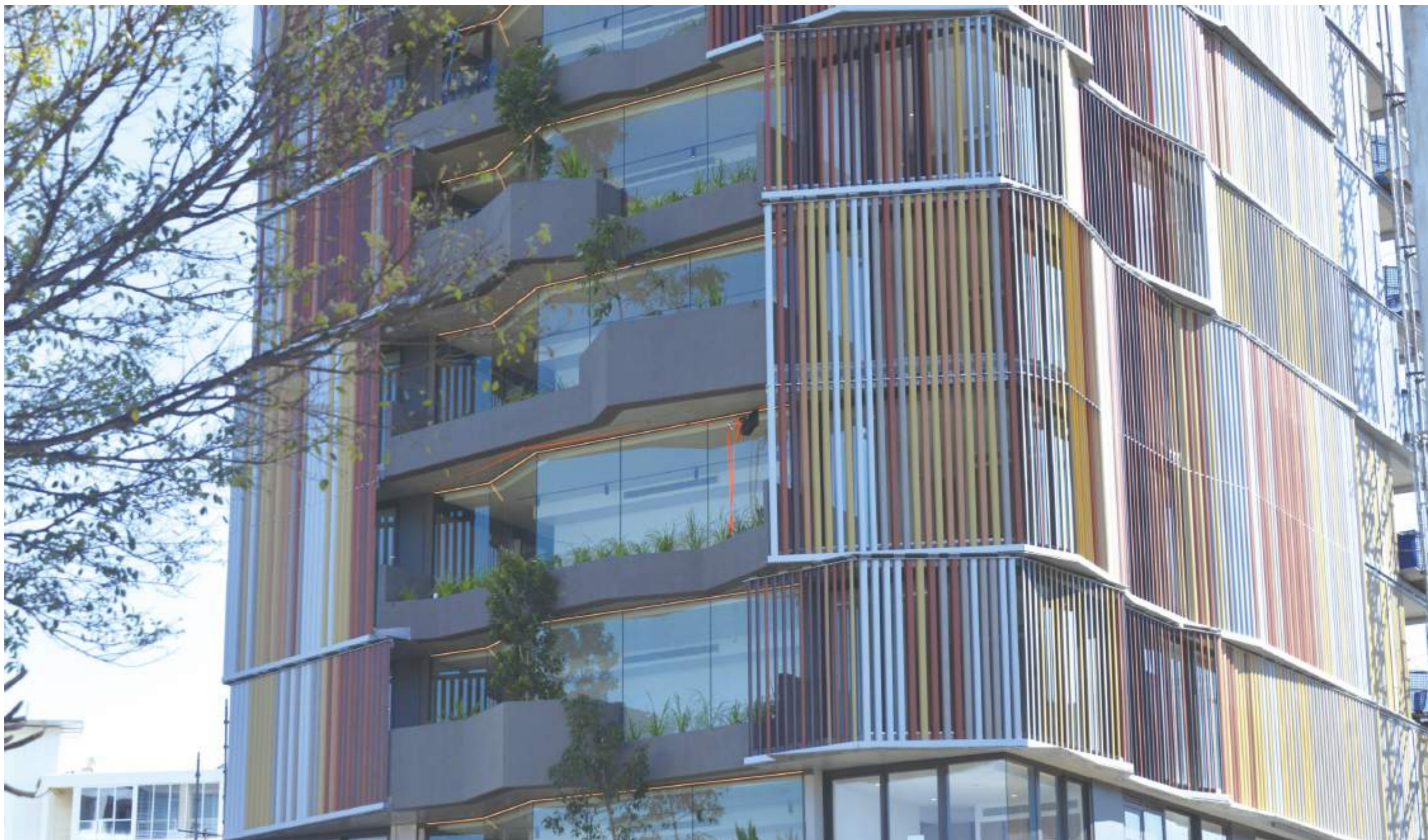





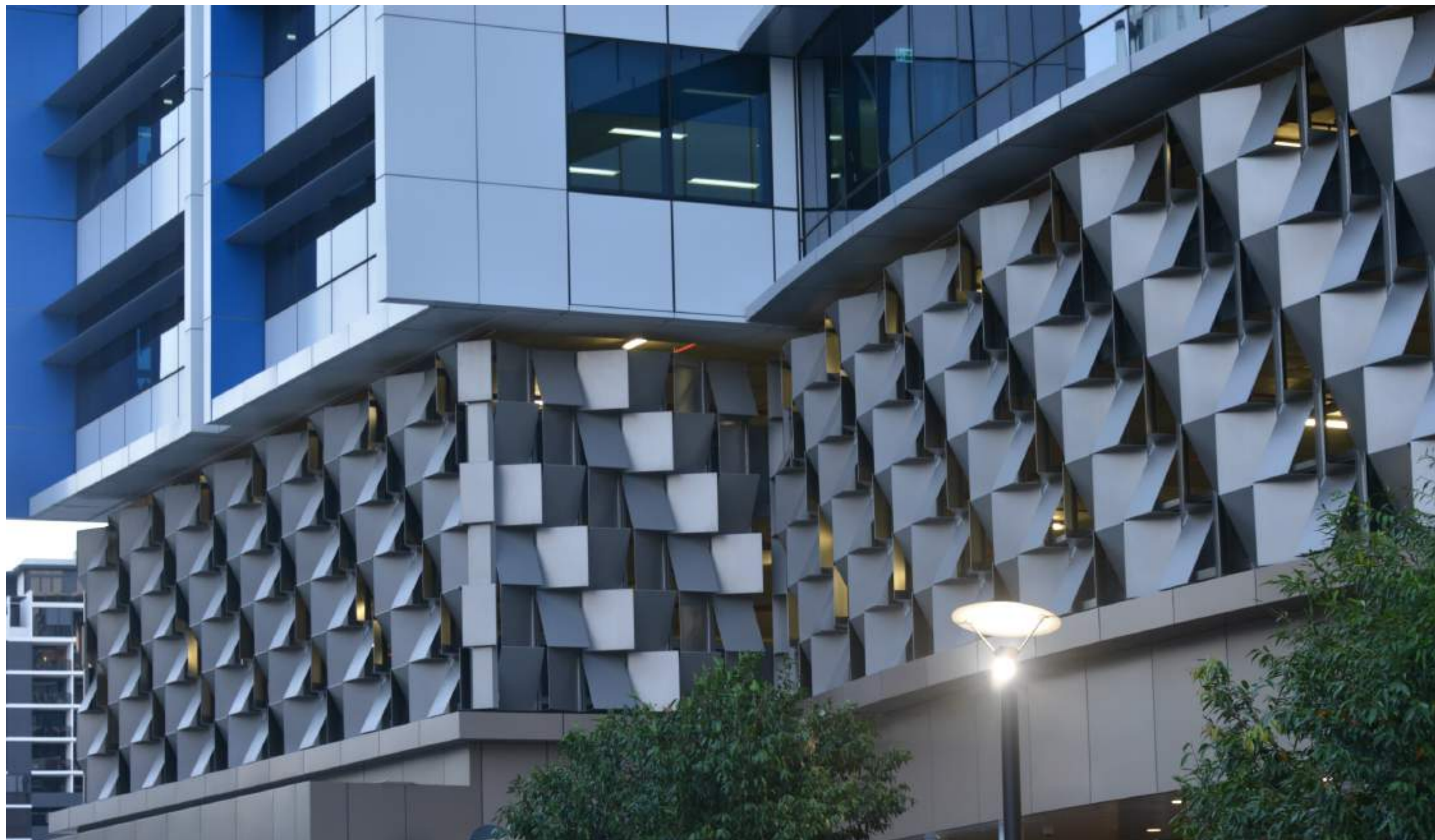







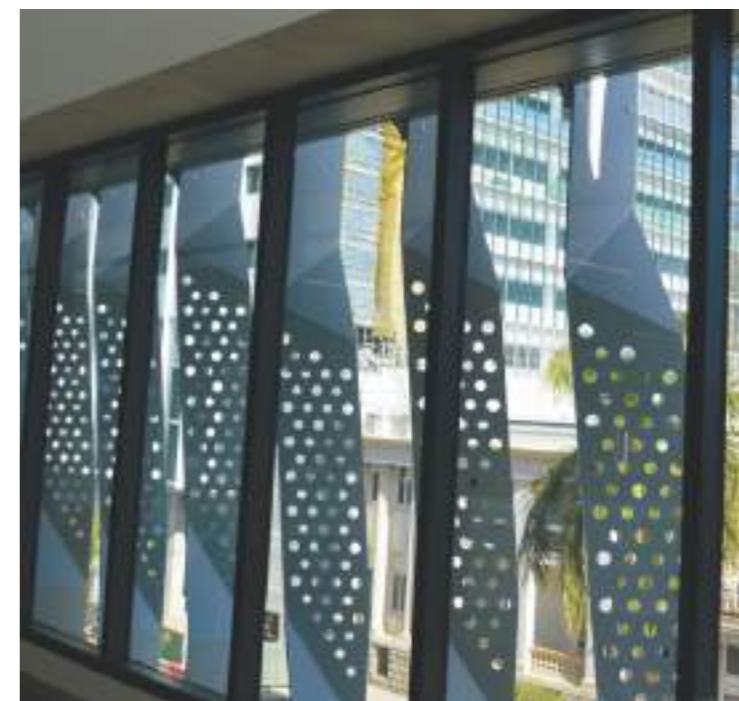

ABOUT YONGFENG

Founded in Oct. 1995

25000+ tons Aluminum Profile Annual Capacity

1000+ Aluminum Louver Products

Aluminum Louver Commercial Solution

ISO 9001/14001 Certified

Patent Technology



 NOTES

 NOTES

